

Pioneering for You

wilo

Catalogue Building Services 2018

OEM High Efficiency Circulation Pumps

Glandless Pumps and Accessories



Imagine you already had the solutions today that will be needed tomorrow.



With OEM Solutions, what is visionary is just a step away from reality. As the leading original equipment manufacturer, we see ourselves as part of your business and we know exactly how crucial your processes are. We work with you to develop customized innovative solutions making you a pioneer in your market. We produce these solutions for you at the time you choose, to sustainable, top quality. This will benefit your entire business. From senior management to purchasing. From logistics to research and development. Thanks to highly committed teamwork for your success. **OEM Solutions. Let's move. Together.**

Pioneering for You

wilo

Overview

General notes

Program overview and fields of application	Page 4
Planning guide	Page 6

Heating, air-conditioning, cooling

Wilo-Para	Page 34
Wilo-Para STG	Page 98
Wilo-Yonos PARA HighFlow	Page 102
Wilo-Stratos PARA	Page 108
Accessories	Page 168

Solar thermal energy systems

Wilo-Para ST	Page 124
Accessories	Page 168













Geothermal energy systems









Wilo-Para G	Page 137
Wilo-Stratos PARA	Page 108
Wilo-Yonos PARA High Flow	Page 102
Accessories	Page 168

Domestic hot water

Wilo-Yonos PARA-Z	Page 150
Wilo-Stratos PARA	Page 154
Accessories	Page 168

Program overview and fields of application

Pump housing type	  Heating and cooling systems	 Geothermal	 Solar	 Sanitary	Page
 RS	•	•	•		35
 RSB	•				44
 RS KU	•				49
 RSL KU	•				55
 BSL	•				61
 KSL	•				67
 MSL	•				74

Pump housing type	 				Page
 NFSL	•				81
 HU 15	•				87
 HU 25	•				87
 Yonos PARA Z				•	150

Abbreviation	Meaning
1~	1-phase current
Δp	Differential pressure
$\Delta p-c$	Control mode for constant differential pressure
$\Delta p-v$	Control mode for variable differential pressure
EM	Single-phase motor, 1~
EnEV	German Energy Conservation Legislation
ErP	It applies to energy-related products. ErP Directive 2009/125/EC establishing a framework for the setting of environmentally-responsible requirements for energy-driven products. Formerly the Ecodesign Directive (EuP Directive 2005/32/EC).
ECM technology	Electronically commutated motor with new wet rotor encapsulation, newly developed glandless drive concept for high-efficiency pumps
$^{\circ}dH$	Degree of German water hardness; replaced by the SI unit mmol/l; conversion $1^{\circ}dH = 0.1783 \text{ mmol/l}$
H, H_{max}	Delivery head
Cataphoretic coating	Cataphoretic coating (electrophoretically deposited paint, EDP): paintwork with high adhesive strength for long-lasting corrosion protection
P1	Power consumption (power supplied from the network)
PN	Pressure class in bar (e. g. PN10 = suitable up to 10 bar)
PWM	Pulse-width modulation. PWM signal for external activation of functions
iPWM	intelligent (bidirectional/two ways communication) Pulse-width modulation. PWM signal for external activation of functions and returned signal flow
LIN	The pump is controlled by an external system via LIN bus communication
Q (=V)	Volume flow
SBM	Run signal or collective run signal
SSM	Fault signal or collective fault signal
Control input, 0-10 V	Analog input for external control
TrinkwV 2001	German Drinking Water Ordinance of 2001 (valid from 01.01.2003)
VDI 2035	VDI guideline for preventing damage in hot-water heating installations
WRAS	Water Regulations Advisory Scheme (portable water approval for Great Britain and Northern Ireland)

Introduction

As the first high-efficiency pump in the world, the Wilo-Stratos defined energy efficiency class A for stand-alone circulators, thereby setting a new standard. Wilo extended this product technology towards new pump ranges especially for requirements of the OEM industry. The product ranges Wilo-Para, Wilo-Yonos PARA, Wilo-Yonos PARA High Flow and Stratos PARA are the new generations of high-efficiency pumps especially designed in line with the demands of OEM industry regarding hydraulic performance, scope of functionality, space restrictions and costs. The scope of all pump ranges is precisely tailored to meet the individual requirements of the market and customers and have the following advantages:

- Concentrating on the essentials
- Maximum efficiency thanks to ECM technology
- Up to 80 % energy savings compared with uncontrolled circulators
- Meet all the new requirements of the ErP directive (2009/125/EC)
- For heating, solar, geothermal energy systems and cooling
- Intelligent design
- Optimal performance in the smallest space
- High starting torque for reliable starting
- Prevention of flow noise
- Quick and safe installation thanks to a standard delivery with plug for an easy electrical connection
- Simple operation and convenient setting of the pump via external control signals or the push button technology
- Cast iron pump housing with cataphoretic (KTL) coating for the prevention of corrosion from condensation formation
- Large range of composite housings for heating and domestic hot water applications

Energy-related Products (ErP) Directive (2009/125/EC Directive)

Following the Kyoto Protocol from Dec. 1997, the European Commission has set up measures to achieve a 20 % reduction on both energy consumption and CO₂ - emission until 2020, based on the data from 1990. One of these measures is the ErP Directive. Conformity with the derived EU regulations will be governed through mandatory CE Marking.

In Nov 2009 the original “Eco-design Directive” of Energy using Products (EuP, 2005/32/EC Directive) has been modified and became the Energy related Product (ErP, 2009/125/EC) Directive. It now covers also measures on products as windows.

The earlier defined Commission Regulation (EC) No 641/2009 amended by (EU) No 622/2012 on circulators with a rated power output between 1 W and 2500 W stays unchanged and is based on these Directives.

From **1 January 2020**, as well all replacement circulators for identical circulators integrated in products before August 2015 shall have an energy efficiency index (EEI) of not more than 0.23.

After these dates Wilo is not allowed any more to bring circulators not fulfilling these EEI values into the european market.

The prEN 16297-1 ... -3 describes how to measure the EEI. The measurement procedure for integrated circulators takes into account various integrated functions available in the many customized hydraulic solutions.

Examples can be

- Hydronic heating and secondary cooling circuits
- Boilers
- Heat pumps
- Combined heat and power stations
- Solar thermal systems
- District heating house stations
- Assembly kits for radiator or under floor heating systems
- Secondary hydronic cooling distribution and heat recovery circuits
- DHW system boiler

Circulators NOT affected by new legislation ‘Drinking water circulators’, except with regard to information requirements of Annex I, point 2(4). ‘Drinking water circulator’ means a circulator specifically designed to be used in the recirculation of drinking water as defined in Council Directive 98/83/EC.



Electronic performance control

Heating pumps are, due to their high annual operating hours, among the largest power-consuming appliances in buildings. After the compressor in heat pumps and in other systems of heating applications, the circulation pump is the biggest consumer of electrical power and is therefore the major efficiency factor for the entire application. Automatic pump performance control helps drastically to reduce power consumption in heating pumps. Compared to standard pumps, high-efficiency pumps can even save up to 80 % electricity costs. All operating states, in particular in the partial load range that is typical for heating systems, can be optimised hydraulically by means of automatic pump performance control. A further significant effect connected with the prevention of a rise in pump pressure is the avoidance of flow noise in thermostatic valves.

* The energy Efficiency Index (EEI) is a specific parameter to qualify the performance of circulators in terms of efficiency. The EEI takes the capacity of the circulator into account to adapt its operative condition with a maintained high efficiency level.

High-efficiency pumps

The efficiency of the hydraulics and the motor determine the pump's overall efficiency. Both components were doubled with the Wilo EC pump compared to the glandless pumps previously used in building services, thus resulting in a considerable improvement. The applied ECM technology drastically reduces the annual power consumption, which again results in considerable savings compared to conventional pumps.

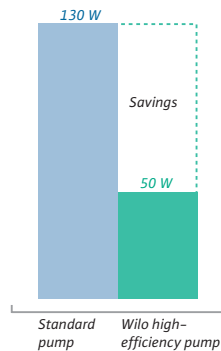

ECM technology

The new ECM technology is the basis for the outstanding efficiency of the Wilo-OEM series Para and Stratos PARA. It includes:

EC motor

EC motor stands for electronically commutated motor. Its basis is a synchronous motor with permanent magnet rotor. The rotating stator's magnetic field is generated by electronic commutation, meaning that the stator windings are activated specifically for the interaction of the electrical and magnetic poles.

This has the following benefits:

- The magnetic field required in the rotor does not need to be generated with any losses.
- Especially in the partial load range (up to 98% of the operating time), the difference in efficiency is even greater than it already is in the full load range compared to an asynchronous motor.
- Higher speeds are possible compared to an asynchronous motor. This results in the reduction of the size and weight of the pump with similar hydraulics.

Wet rotor encapsulation

The rotor of the glandless pump motor runs in the fluid. This fluid lubricates the bearings and cools the motor. The current-carrying stator is separated from the fluid by a can, referred to as wet rotor encapsulation. This wet rotor encapsulation has a direct effect on the efficiency

- due to the size of the necessary gap between stator and rotor,
- and due to the magnetic resistance of the selected can material.

The improvement in terms of efficiency of the Wilo-Stratos/Para pump here is the result of:

- Reduction of the air gap and

- Application of an innovative can material with smaller losses to the magnetic flux between stator and rotor.

Motor protection

The standard integrated protection device reliably protects the Wilo-Para and Wilo-Stratos PARA, in all settings, against excess temperature, low/excess voltage, excess current, blocking as well as dry running.

This has the following advantage:

No external motor protection switch is required. The connecting instructions of the local electricity supply companies are to be observed.

Minimum inlet pressure for the prevention of cavitation

To prevent cavitation (vapour bubble formation within the pump), it is necessary to maintain a sufficiently high over pressure (suction head) at the pump suction port in relation to the vapour pressure of the fluid being pumped.

The minimum suction heads are listed in the respective tables for all glandless pumps.

For higher altitudes than 300 m above sea level: add 0,1 m head/100 m height increase.

These minimum heads must be respectively increased when handling fluids of higher temperatures or lower densities, higher resistances at the circulator suction side and in regions of lower atmospheric pressures.

All Wilo -pump series with electronic box can't be used 2,000m above the sea.

Pump curves

All pump curves included in the catalogue apply to the pumping of water (kinematic viscosity = 1 mm²/s & Temperature = 25°C for voltage = 230 V). If fluids of different density and/or viscosity are pumped (e.g. water-glycol mixtures), the hydraulic values of the pump and the pipe system will deviate. It is recommended that the data is only measured after a minimum of 24h running-in. Following EN 16-297.

Minimum volume flow

Larger pumps require a minimum flow rate to ensure trouble-free operation. Operating against a closed slide valve, volume flow Q = 0 m³/h, can lead to overheating inside the pump.

Standards/directives

- CE marking (all Wilo pumps)
- Certification according to:
 - ISO 9001,
 - ISO 14001

Quality and safety mark

For pump types:

Wilo-Para

Wilo-Yonos PARA

Wilo-Yonos PARA High Flow

Wilo-Stratos PARA



Notes on installation and operation

Installation

Installation inside a building

Glandless pumps must be installed in dry, well-ventilated, frost-free rooms.

Installation outside a building (outdoor installation)

The glandless pumps of the following series are suitable for outdoor installation:

- Wilo-Para
- Wilo-Yonos PARA/Yonos PARA High Flow
- Wilo-Stratos PARA

The following conditions must be complied with:

- Installation of the pump in a sump (e. g. light sump, ring sump) with cover or in a cabinet/housing for protection against the weather
- Avoidance of direct sunlight on the pump
- Protection of the pump against rain. Dripping water from above is allowed as long as the pump is installed in an appropriate installation position
- In order to ensure that waste heat is dissipated, the motor and the electronics must be ventilated at all times
- Fluid and ambient temperatures may not exceed or fall below the admissible values

Condensation water

All standard pumps for cold water applications down to -10°C are fully condensation-proof. The grey cast iron pump housing of the following series

- Wilo-Para
- Wilo-Yonos PARA/Yonos PARA High Flow
- Wilo-Stratos PARA
is equipped with a special coating (cataphoretic coating) for a subsequent surface finishing.

The benefits of this coating are:

- Optimum corrosion protection against condensation formation on the pump housings in cold water installations
- Very high scratch and impact resistance
- **Important:** Do not obstruct the condensation hole

Intermittent operation

The series

- Wilo-Para
- Wilo-Yonos PARA/Yonos PARA High Flow
- Wilo-Stratos PARA

can also be used for intermittent (ON/OFF) operation.

The maximum admissible number of switchings during the life time of the pump is 300,000 times (80,000 operating hours) at a minimum time period of 5 s between two switchings.

Connections

Screw-end pumps

Screw-end pumps are equipped with connecting threads in accordance with DIN EN ISO 228, Part 1. Seals are on request in the scope of delivery.

Wilo recommends the use of flat gaskets type EPDM 70 shores for cast iron, bronze or composite pump housings.

Electrical connection

- All Wilo pumps are made for a voltage of 230 V (tolerance $+10\%/-15\%$).
- It is not recommended to use WILO high efficiency pumps in combination with a Triac control for ON/OFF switching. Relay control should be used here.
- All Wilo pumps made after 1 January 1995 have been labelled with the CE marking in accordance with relevant EU Directives.
- When pumps are used in systems with fluid temperatures above 90°C , **a suitably heat-resistant connecting pipe must be used.**

Life time, wear and tear

The pumps and their components for OEM applications described hereafter are designed for 80000 operating hours. Pumps or parts of pumps are subject to wear in accordance with state-of-the-art technology (DIN 31051/DIN-EN 13306). This wear may vary depending on operating parameters (temperature, pressure, speed, water conditions) and the installation/usage situation and may result in the malfunction or failure at different times of the aforementioned products/components, including their electrical/electronic circuitry. Wearing parts are all components subject to rotary or dynamic stress, including electronic components under tension, in particular:

- Seals (including mechanical seals), seal rings
- Bearings and shafts
- Impellers and pump components
- Relays
- Electronic circuits, semiconductor components, etc.

We do not accept any liability for faults or defects arising from natural wear and tear.

Pump replacement

No spare parts are available for OEM pumps. In the event of damage, the complete pump needs to be replaced.

Safety information

Faults of electronic devices due to electromagnetic fields

Electromagnetic fields are created during the operation of pumps with frequency converter. Interference of electronic devices may be the result. The result may be a device malfunction, which can result in damage to the health or even death, e. g. of persons carrying implanted active or passive medical devices. Therefore, during operation the presence of any persons e. g. with cardiac pacemakers in the vicinity of the unit/pump should be prohibited. With magnetic or electronic data media, the loss of data is possible.

WARNING! Danger due to strong magnetic field!

Inside the machine there is always a strong magnetic field that can cause injury and damage to property in the event of incorrect dismantling.

→ It is only permitted to have the rotor removed from the motor housing by qualified personnel! There is a crushing hazard! When pulling the rotor out of the motor, it may be suddenly pulled back into its initial position by the strong magnetic field. If the unit consisting of impeller, bearing shield and rotor is pulled out of the motor, persons with medical aids, such as cardiac pacemakers, insulin pumps, hearing aids, implants or similar are at risk. Death, severe injury and damage to property may be the result. For such persons, a professional medical assessment is always necessary. Electronic devices may be impaired functionally or damaged by the strong magnetic field of the rotor. If the rotor is outside the motor, magnetic objects may be attracted very suddenly. That can result in injury and damage to property. In assembled condition, the rotor's magnetic field is guided in the motor's iron core. There is therefore no harmful magnetic field outside the machine.

Wilo – General Terms of Delivery and Service

The latest version of our General Terms of Delivery and Service can be found on the Internet at www.wilo.com/en/legal

Wilo-Para



The Wilo-Para is the latest high-efficiency pump series which is specially designed in order to fulfill the special demands of the OEM industry. The Wilo-Para sets the standard for energy-saving solutions required for integrated hydraulic systems. Equipped with a self controlled push button or externally iPWM control, the Wilo-Para is the perfect choice for a one-to-one replacement of most existing electronic pumps. This series is available in various cast iron and composite pump housings and is thus highly versatile. At the leading edge of technology, the Wilo-Para provides best-in-class performances: it has a three times higher starting torque than most comparable heating pumps and fulfils highest mechanical, electrical and hydraulic requirements.

Special features/product benefits

- “Best in class” High Efficiency pump of the market due to ECM technology
- Up to 80 % electricity savings compared to previous uncontrolled range of heating pumps
- Self controlled pump (push button) or externally controlled (iPWM signal)
- Unique LED user interface gives information about the pump functioning
- High starting torque for reliable start-up
- Hot water heating systems of all kinds, in the temperature range of -10°C to $+95^{\circ}\text{C}$ (110°C for ST version)
- Designed for easy integration due to compact design
- Inrush current peak less than 3A
- Self protecting modes of electronic motor
- Preventing flow noises
- Stand-by consumption less than 0.5 W
- Functions adapted specially to the demands of the OEM market
- Cathodically coated (KTL) cast iron pump housing to prevent corrosion when condensation occurs, or OEM composite pump housing

Heating application

In nearly all circulation systems, correctly sized controlled glandless pumps ensure adequate heat supply at all times at significantly reduced energy costs, while at the same time preventing noise generation.

Sanitary hot water application (Wilo-Yonos PARA-Z)

Pumps which are used in sanitary hot water circulation systems are subject to specific requirements that are fulfilled by the Wilo-Yonos PARA-Z series:

- Fluids are potable water and water for food companies according to TrinkwV 2001. Possible deposits of lime were considered in the design so that a total carbonate hardness of 20°d at a max. fluid temperature of $+80^{\circ}\text{C}$ is permitted.
- All plastic parts that come into contact with the pumped liquid comply with KTW recommendations.

Electronic performance control

Self controlled model with green push button

- Δp -v, Δp -c, constant speed
- Expert functions activated via Green push button

Available control modes

Control mode Δp -c:

In the Δp -c control mode, the electronic module keeps the differential pressure generated by the pump constant at the set differential pressure setpoint H_s over the permissible volume flow range.

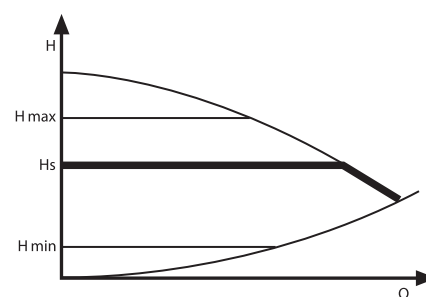

Control mode Δp -v:

In the Δp -v control mode, the electronic module changes the differential pressure setpoint to be maintained by the pump in linear fashion between H_s and $\frac{1}{2} H_s$. The differential pressure setpoint value H varies with the volume flow Q .

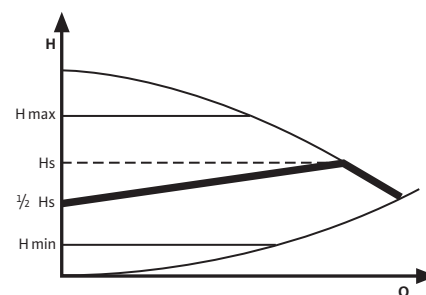

Venting routine

The integrated venting routine supports a bleeding of the overall heating system. After a manual setting, the routine runs for 10 minutes alternating at low and high speed of the pump. At the end of the process, the pump switches automatically to a pre-set speed. After that, the desired control mode can be set by push button.

Constant speed I, II, III

In this operating mode the pump is not self regulating its speed. The pump is operating constantly with a fixed speed in pre-setted position.

Manual control panel

The control mode and the differential pressure setpoint at $\Delta p-c$ for constant differential pressure, $\Delta p-v$ for variable differential pressure and pre-setting the constant speed can be set easily and safely, directly at the pump. Depending on customer wishes, a pre-setting of the control mode/ setpoint can be done at the Wilo factory.

LIN interface



Lin Bus is a communication bus widely used and which gives the opportunity to enlarge the data exchanges in between pump and application controller.

Pump functions can be activated by the Bus and data packages by sets of periodic or punctual data frames, are provided (e.g. flow information and speed..., and several pump status).

For more technical details about Lin Bus, please contact us.

iPWM interface



iPWM stands for intelligent Pulse-width modulation and includes a bidirectional communication between pump and application controller.

Pump functions can be activated by external signal and a returned signal is given (e.g. flow information or pump status).

2 signal logic types (heating and solar) are available in order to fit with control logic of the appliance.

For more technical details about iPWM, please contact us.

Electrical connection

IMPORTANT

Pay attention to the power plug. Check plug position before insertion.

To ensure a safe and easy electrical connection, the Wilo-Para pumps is equipped with an integrated Molex 3-way connector and depending on the available functions, with a control cable.

Note: the cable is not mounted

Mains connection

For mains power supply 1~230 V/50 Hz

Para with integrated Molex 3-way connector

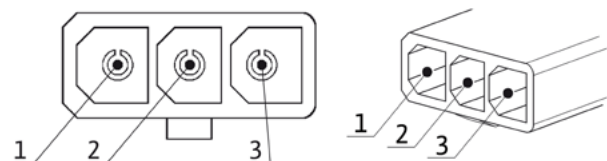

- 1) L1, 1~230 V/50 Hz
- 2) Neutral N
- 3) Earth conductor

The mating plug to the OEM-plug can be ordered with one of the following suppliers:

LTE (www.lte.it)

FACON (www.facon.it)

Wilo does not assume any liability for the products supplied by these manufacturers

Available power cables

On request

0.5 m, 3-core cable with end splices
1 m, 3-core cable with end splices
1.5 m, 3-core cable with end splices
2.0 m, 3-core cable with end splices
according to customer specifications

iPWM/LIN connection

For connecting the analog iPWM of LIN interfaces

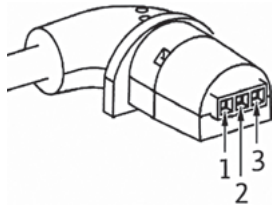

- Core no. 1 (brown)
- Core no. 2 (blue or grey)
- Core no. 3 (black)

Available iPWM/LIN control cables

On request	0.5 m, 3-core cable with end splices 1 m, 3-core cable with end splices 1.5 m, 3-core cable with end splices 2.0 m, 3-core cable with end splices according to customer specifications
------------	--

The mating plug to the OEM-plug can be ordered with one of the following suppliers. (Wilo does not assume any liability for the products supplied by these manufacturers):
 LTE (www.lte.it)
 FACON (www.facon.it)

Note:

To ensure interference resistance, the total length of the PWM/LIN control cable must not exceed 3 m

iPWM:

- Cable assignment:
- 1 brown: PWM input (from controller)
- 2 blue or grey: Signal earth (GND)
- 3 black: PWM output (from the pump)

LIN:

- Cable assignment:
- 1 brown: 12 V DC to 24 V DC (+/-10 %)
- 2 blue or grey: Signal earth (GND)
- 3 black: LIN bus data

Designation, name plate of the Wilo-Para series (SC version)



- 1 Pump type
- 2 Article number
- 3 Production date (year/week)
- 4 Protection class IP/current consumption/Electricity
- 5 Operating pressure/max. Fluidtemperature/ Voltage/Frequency
- 6 Wilo Label number
- 7 Serial number
- 8 Energy efficiency index (EEI)
The benchmark of the most efficient circulator is $EEI \leq 0.20$, part 3
- 9 QR-code
- 10 Address
- 11 Certification and CE declaration

Permitted installation positions Wilo-Para

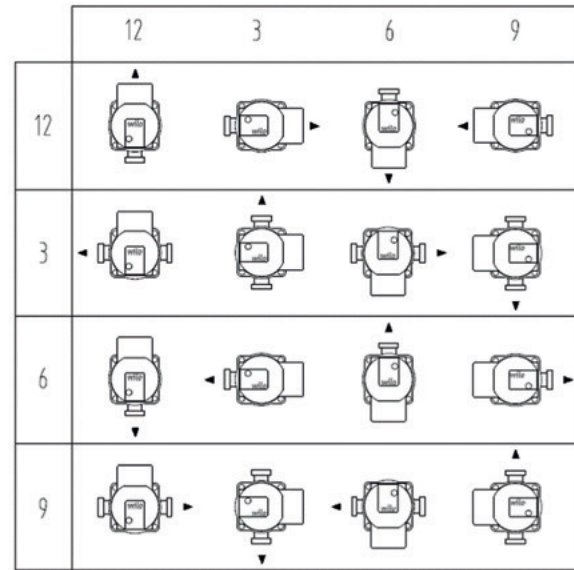

3, 6, 9 and 12 o'clock are the electronic module positions for the indicated direction of flow at the pump housing.
Impermissible installation positions

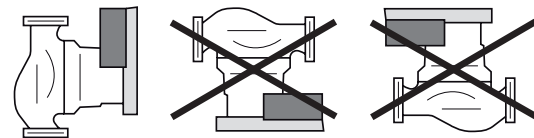

Horizontal position

Max deviation in both directions: 7 degree

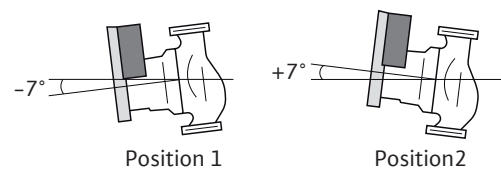

Transport and interim storage

Immediately after receiving check the product for damage in transit.

Transport conditions

The device must not be exposed to temperatures outside the range of -40°C up to $+85^{\circ}\text{C}$ The transport conditions must be applied max. three months.

Storage conditions

The device must not be exposed to temperatures outside the range 0°C up to $+40^{\circ}\text{C}$. The storage time can be up to two years. The remaining water, in case of customer production tests, cannot lead to frost damages.

Wilo-Yonos PARA High Flow



The Wilo-Yonos PARA High Flow is the latest Wilo high-efficiency pump series in glandless construction which can be used both for

- Hot-water heating systems of all kinds
- Closed cooling circuits
- Circulation in solar thermal and geothermal systems in all OEM applications and it offers the following advantages:

Field of application

The series Wilo-Yonos PARA High Flow is used as high-efficiency pump in circulation systems for heating, ventilation and air-conditioning applications in commercial and residential buildings:

- Large residential buildings
- Apartment buildings
- Residential complexes
- Hospitals
- Schools
- Administrative office buildings
- Real estate developments

Product advantages and USP (unique selling propositions)

- Automatic adjustment of pump output to continuously varying load conditions of the hydraulic system
- Prevention of flow noise
- Use in heating and air-conditioning applications from -20°C to $+110^{\circ}\text{C}$ medium temperature.
- Maximum efficiency thanks to ECM technology
- LED display for the indication of nominal delivery head and fault codes
- Control range from 0.5 m set delivery head
- Preselectable control modes for optimum load adjustment $\Delta p\text{-c}$ (differential pressure constant), $\Delta p\text{-v}$ (differential pressure variable)
- Preselectable constant speed mode (3 predefined fixed speed curves)
- Quick and convenient electrical connection with Wilo-Connector
- Collective fault signal on all types for assuring system availability
- Simple installation due to PN 6/PN 10 combination flanges (with DN 40 to DN 65)
- Pump housing with cataphoretic coating for preventing corrosion due to condensation formation
- Safety and comfort during installation and operation

- Integrated motor protection
- Variable installation positions

Heating application

In nearly all circulation systems, correctly sized controlled glandless pumps ensure adequate heat supply at all times at significantly reduced energy costs, while at the same time preventing noise generation.

Thermal insulation for heating

In order to prevent heating loss through the pump housing, the single pumps of the series Wilo-Yonos PARA High Flow are available with a thermal insulation shell as accessory.

The PP material used, foamed polypropylene, has the following properties:

- Environmental compatibility: easy to recycle
- Thermal resistance: up to 120°C
- Flammability: Class B2 in accordance with DIN 4102 (normal flammability)

Normally flammable materials are permitted for use in heated rooms in Germany in accordance with fire prevention regulations as long as a minimum clearance of 20 cm is maintained between them and the fireplace.

Air-conditioning/cooling application

The restriction for conventional variable speed pumps in terms of the dependency of the fluid temperature on the ambient temperature does not apply to the Wilo-Yonos PARA High Flow pump. Condensation forms on cold surfaces if the fluid temperature is lower than the ambient temperature. The Wilo-Yonos PARA High Flow pump can also be used in such cases. It is designed in such a way that damage to electrical parts caused by condensation water is avoided.

Isolation for air-conditioning/cooling

If the pump housing is given diffusion-proof insulation onsite, the insulation may not cover the drain labyrinth between pump housing and motor. That ensures that any condensate having possibly accumulated in the motor can drain off freely through the condensate drain openings in the motor housing.

Corrosion-proof pump design

Corrosion-proof designs are required for e. g. cooling ceilings or ceiling heating panels. For these applications, the pump housing is coated.

ECM technology

EC stands for electronically commutated motor. Its basis is a synchronous motor with permanent magnet rotor. The rotating stator's magnetic field is generated by electronic commutation, meaning that the stator windings are activated specifically for the interaction of the electrical and magnetic poles.

Wet rotor encapsulation

The rotor of the glandless pump motor runs in the fluid. This fluid lubricates the bearings and cools the motor. The current-carrying stator is separated from the fluid by a can, referred to as wet rotor encapsulation.

- due to the size of the necessary gap between stator and rotor, and due to the magnetic resistance of the selected can material.

The improvement in terms of efficiency of the Wilo-Yonos PARA

High Flow pump here is the result of:

- Reduction of the air gap and
- Application of an innovative can material with smaller losses to the magnetic flux between stator and rotor.

Automatic power control

The volume flow pumped through a circulation pump depends on the thermal output/cooling output requirement of the system being supplied. This requirement varies according to:

- Climatic changes
- User behaviour
- External heat influence
- Influence of hydraulic control devices, etc.

The circulation pump designed for maximum load conditions is adapted to the relevant system operating status by means of a continuous comparison of the setpoint and the actual value. This automatic control constantly adapts the pump output and thus also the power consumption to the actual demand.

Automatic venting

The rotor space is ventilated automatically by the filter and flow channel system.

This has the following benefits:

- The automatic ventilation of the rotor space is accelerated, thus reducing both dryrunning times and ventilation noise.
- Damage to the radial bearings or to the can is reduced by the filtering feature.

Motor protection

The standard integrated protection device reliably protects the pump, in all settings, against excess temperature, excess current and blocking.

This has the following advantage:

- No external motor protection switch is required. If, in the case of replacement, there is a motor protection switch in the electrical installation that cannot be bridged, then it is to be set to the maximum current specified on the name plate.

Features of the user interface (HMI)

- LED 7 segments display for the indication of the delivery head and error messages
- Red button
- Simple selection of the operating mode $\Delta p-v$, $\Delta p-c$
- Output of a collective fault signal
- Fault signal light
- Standard plug for all sizes

Signal and display functions

- Collective fault signal (potential-free contact) for the connection of building automation
- Fault signal light (a red light in the case of an interference)

Manual operation level

Operating button

The Wilo-Yonos PARA High Flow pump is operated by means of the proven red-button technology (one button operation). The important basic functions can be set easily and safely, directly at the pump.

Control modes

Control mode $\Delta p-c$:

In the $\Delta p-c$ control mode, the electronic module keeps the differential pressure generated by the pump constant at the set differential pressure setpoint H_s over the permissible volume flow range.

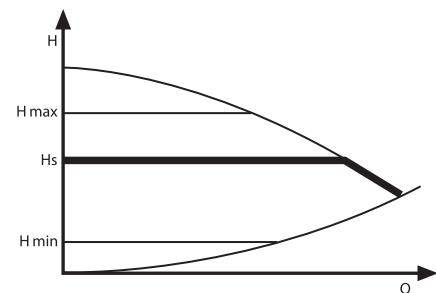

Control mode $\Delta p-v$:

In the $\Delta p-v$ control mode, the electronic module changes the differential pressure setpoint to be maintained by the pump in linear fashion between H_s and $\frac{1}{2} H_s$. The differential pressure setpoint value H varies with the volume flow Q .

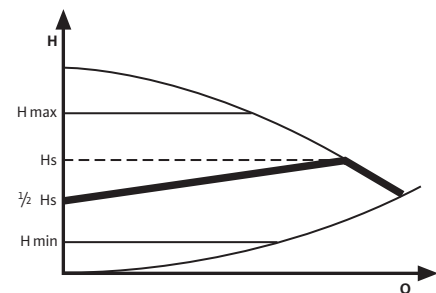

Control mode n-constant (constant speed)

In the constant speed mode the pump is set on one of the predefined fixed speeds (C1, C2, C3)

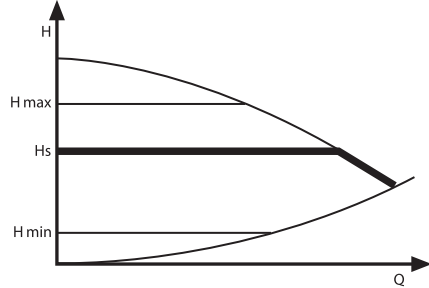

Collective fault signal SSM

A collective fault signal is available as potential-free contact, designed as NC contact in accordance with VDI 3814.

Contact load:

- Permitted minimum: 12 V DC, 10 mA
- Permitted maximum: 250 V AC, 1 A

The contact is closed under the following conditions:

- The pump is without current
- There is no fault
- Total failure of the control module

The contact is open under the following conditions:

The pump is powered and there is one of the following faults

- Blocking-current proof, motor
- Excess temperature control module
- Excess current
- Blocking of pump
- Faulty contact between motor/control module
- Mains undervoltage
- Mains overvoltage

Electrical connection

The control module of the Wilo-Yonos PARA High Flow is freely accessible. The Wilo plug is used for the electrical connection. It is possible to remove the plug from the module and open it. Like this the electrical connection is very easy.

All high-efficiency pumps of the Wilo-Yonos PARA High Flow series can be connected to the following voltages and frequencies:

- 1~230 V, 50/60 Hz, tolerance in accordance with DIN IEC 60038 ± 10 %
- 3~230 V, 50/60 Hz, tolerance in accordance with DIN IEC 60038 ± 10 %

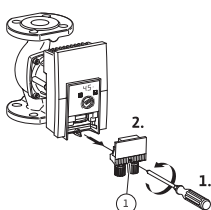

For the electrical connection, the plug must be disconnected from the control module. Loosen the fastening screw of the plug using a Torx or slotted screwdriver. The plug moves itself out of its holding position.

Carefully pull out the plug.

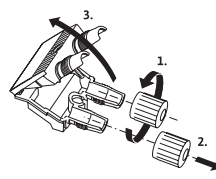

Screw off both threaded cable connections and carefully remove the top part of the plug.

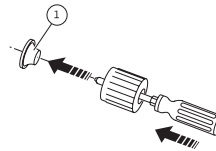

Screw off both threaded cable connections and carefully remove the top part of the plug.

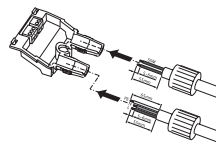

Prepare a cable (provided on-site) for the mains and SSM connection.

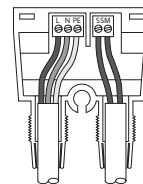

Establish the mains and, if applicable, SSM connection according to the terminal designations and place the cable in the bottom section of the plug.

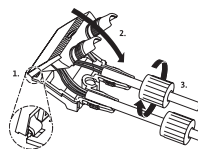

Engage the top section of the plug, hinge bars first, into the hinge openings of the bottom section and fold shut. Screw on threaded cable connections.

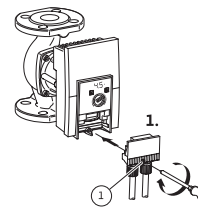

Place the plug at the plug-in position of the control module and screw on using a Torx or slotted screwdriver. The plug is joined in its end position as it is screwed into place.

Operation on residual-current devices (RCD)

The operation of the Wilo-Yonos PARA High Flow series on residualcurrent devices in accordance with DIN EN 61008-1 is permitted without any impairment of the operation of the residual-current device (DIN VDE 0160). Suitable RCD circuit-breakers are indicated by

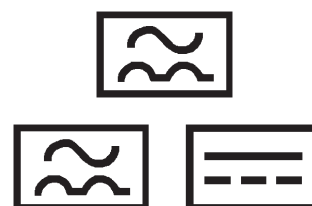

Available cable versions

Standard: pump is delivered without mains and control cable

Permitted install positions

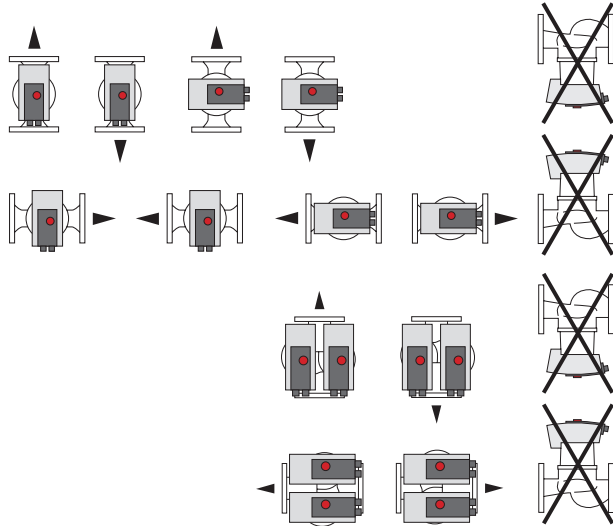

**Designation, name plate of the Wilo-Yonos PARA series
 Type key**

Wilo-Yonos PARA High Flow 25/7

High-efficiency pump	Product family
Yonos PARA High Flow	Series
25	Nominal flange diameter DN
0.5-7	Rated delivery head range in [m]
0.5	lowest selectable delivery head in [m]
7	maximum delivery head in m at $Q = 0 \text{ m}^3/\text{h}$

Transport and interim storage

Immediately after receiving check the product for damage in transit.

Transport conditions

The device must not be exposed to temperatures outside the range of -40°C up to $+85^\circ \text{C}$. The transport conditions must be applied max. three months.

Storage conditions

The device must not be exposed to temperatures outside the range 0°C up to $+40^\circ \text{C}$. The storage time can be up to two years. The remaining water, in case of customer production tests, cannot lead to frost damages.

Wilo-Stratos PARA



The Wilo-Stratos PARA is a Wilo high-efficiency pump series in glandless construction which can be used both for

- Hot-water heating systems of all kinds
- Closed cooling circuits
- Industrial circulation systems
- Circulation in solar thermal and geothermal systems
- Secondary hot water circulation systems of all kinds (Stratos PARA-Z) in all OEM applications and it offers the following advantages:

Special features/product benefits

- Maximum efficiency thanks to ECM technology
- Up to 80 % electricity savings compared to old uncontrolled heating pumps
- High starting torque for reliable start-up
- Can be used in hot water heating systems of all kinds, geothermal and solar thermal systems, closed cooling circuits, industrial circulation systems in the temperature range of -10°C to $+95^{\circ}\text{C}$ ($+110^{\circ}\text{C}$)
- Prevention of flow noise
- Reliability and comfort during installation and operation
- Functions adapted specially to the demands of the OEM market and space-saving design
- Optimum performance also in tight installation situations
- Delivery as standard with a cable for an easy electrical connection
- Convenient setting of the pump via external control signals or the Red-Button technology
- Cathodically coated (KTL) cast iron pump housing to prevent corrosion when condensation occurs

Heating application

The Wilo-Stratos PARA pumps are specially designed for the use in higher ambient temperatures which may occur in OEM systems in heating applications due their space-reduced construction.

Thermal insulation for heating

To avoid heat losses via the pump housing, the single pump series Wilo-Stratos PARA/Stratos PARA-Z come optionally with a thermal insulation shell. The PP material used, foamed polypropylene, has the following properties:

- Environmental compatibility: easily recyclable
- Thermal resistance: up to 120°C
- Transmission coefficient: 0.04 W/mK according to DIN 52612

- Flammability: Class B2 according to DIN 4102 (normally flammable) Normally flammable materials are permitted for use in heated rooms in Germany in accordance with fire prevention regulations as long as a minimum clearance of 20 cm is maintained between them and the fireplace.

Cooling application

Condensation takes place on cold surfaces if the fluid temperature is lower than the ambient air temperature. The Wilo-Stratos PARA can also be used in such conditions. They are constructed in a way that damage to electrical parts caused by condensation water is prevented.

Thermal insulation for cooling

If the Wilo-Stratos PARA pumps are used at low temperatures in geothermal or cooling applications, the insulation must not cover the drain labyrinth between the pump housing/motor. Only then can any condensate having possibly accumulated in the motor drain off freely through the condensate drain openings in the motor housing.

The diffusion-proof Wilo-Cooling-Shell insulation available as accessory for the Wilo-Stratos PARA series for the purpose of insulating pump housings in cold water applications ensures this automatically due to its specific design.

Wilo-Cooling-Shell:

- Water vapour diffusion resistance > 7000
- Normally flammable, according to DIN 4102-B2
- Part 1 quality-monitored as per DIN 18200

Corrosion-proof pump design

Corrosion-proof designs are required for e. g. radiant cooling or heating ceiling panels. For these applications, the pump housing is coated. As an alternative, the Wilo-Stratos PARA-Z with its corrosion-resistant pump housing made of red brass can be utilised as the highest quality version available.

Sanitary hot water application (Wilo-Stratos PARA-Z)

Pumps which are utilised in sanitary hot water circulation systems are subject to specific requirements that are fulfilled by the Wilo-Stratos PARA-Z series:

- Fluids are potable water and water for food companies according to TrinkwV 2001. Possible deposits of lime were considered in the design so that a total carbonate hardness of 20°d at a max. fluid temperature of $+80^{\circ}\text{C}$ is permitted.
- All plastic parts that come into contact with the pumped liquid comply with KTW recommendations.

Sound pressure level

Glandless pumps are low-noise due to their design. Their air-borne noise values with measuring-surface sound pressure level L_p (A) [dB] depend on the motor power output, and are determined under normal operating conditions.

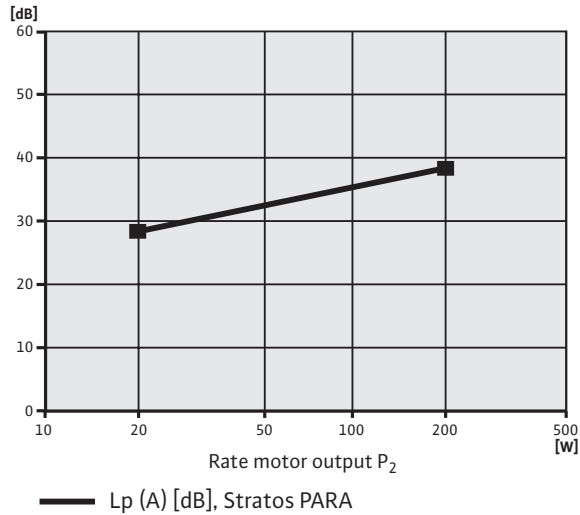

Electronic performance control

Available control modes

Control mode Δp -c:

In the Δp -c control mode, the electronic module keeps the differential pressure generated by the pump constant at the set differential pressure setpoint H_s over the permissible volume flow range.

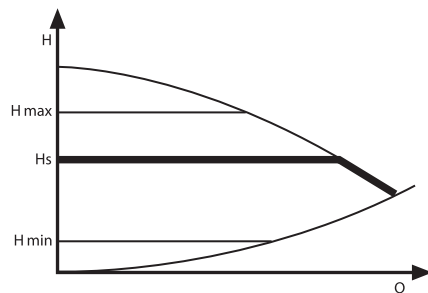

Control mode Δp -v:

In the Δp -v control mode, the electronic module changes the differential pressure setpoint to be maintained by the pump in linear fashion between H_s and $\frac{1}{2} H_s$. The differential pressure setpoint value H varies with the volume flow Q .

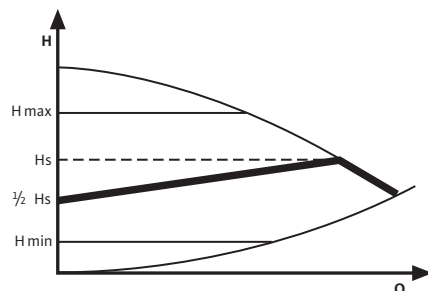

External control functions: ext. in

Control input "0-10 V" (Analog In)

The actual/setpoint level assessment required for control is referred to a remote controller. The remote controller sends an analog signal (0-10 V) as an actuating variable to the Wilo-Stratos PARA.

- Electric strength 24 V DC
- Input resistance of voltage input >100 kOhm

Analog In 0-10 V with cable break detection

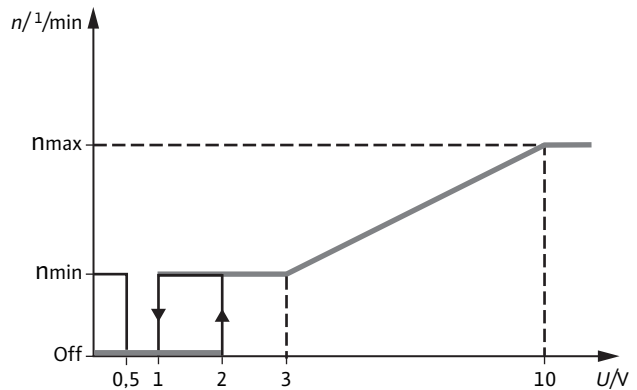

- 0.5 V < U < 1 V: Pump stops
- 1 V < U < 3 V: Pump runs at minimum speed (operation)
- 2 V < U < 3 V: Pump runs at minimum speed (start-up)
- 3 V < U < 10 V: Speed varies between n_{min} and n_{max} (linear)
- U < 0.5 V: Cable break detection, the pump runs at minimum speed (emergency operation)

Analog In 0-10 V without cable break detection

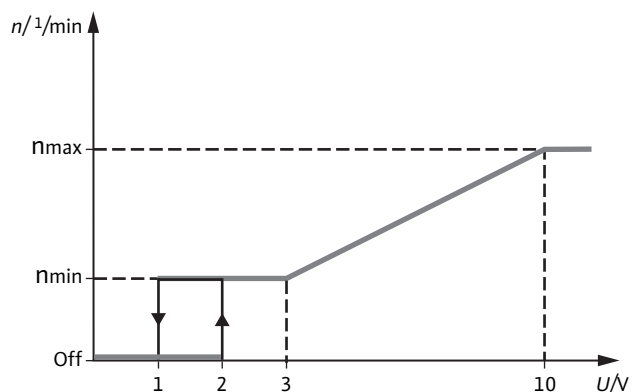

- U < 1 V: Pump stops
- 1 V < U < 3 V: Pump runs at minimum speed (operation)
- 2 V < U < 3 V: Pump runs at minimum speed (start-up)
- 3 V < U < 10 V: Speed varies between n_{min} and n_{max} (linear)

External control via a PWM signal

The actual/setpoint level assessment required for control is referred to a remote controller. The remote controller sends a PWM signal as an actuating variable to the Wilo-Stratos PARA. The PWM signal generator gives a periodic order of pulses to the pump (the duty cycle), according to DIN IEC 60469-1. The actuating variable is determined by the ratio between pulse duration and the pulse period. The duty cycle is defined as a ratio without dimension, with a value of 0 ... 1 or 0 ... 100 %. This is explained in the following with ideal pulses which form a rectangular wave.

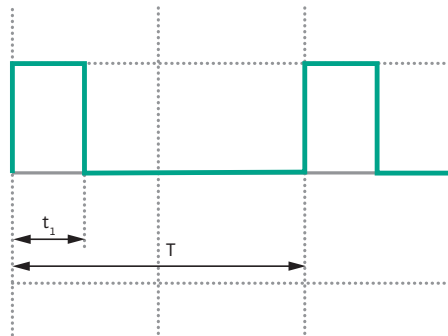

$$t_1 / T = 0,25 = 25\%$$

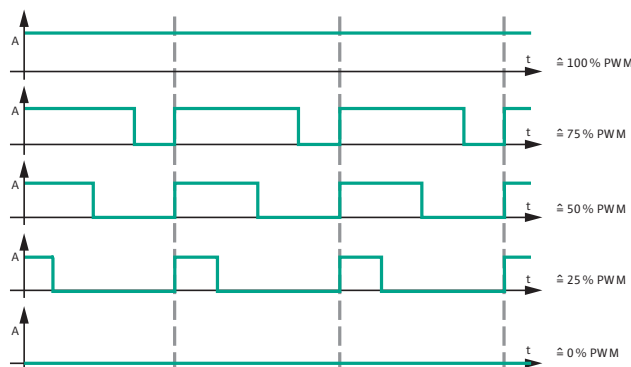

PWM signal logic 1 (heating):

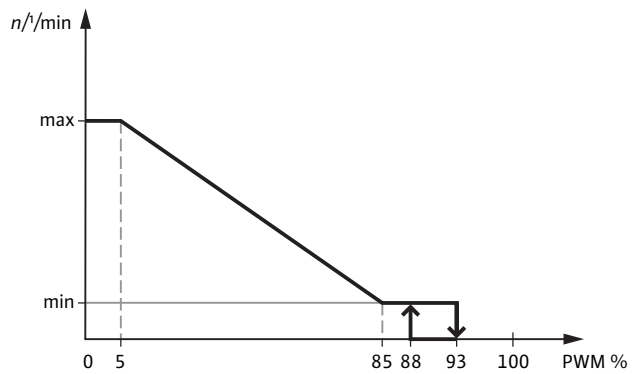

PWM input signal [%]

- < 5 Pump runs at maximum speed
- 5-85 Pump speed decreases linearly from maximum to minimum
- 85-93 Pump runs at minimum speed (operation)
- 85-88 Pump runs at minimum speed (start-up)
- 93-100 Pump stops (Standby)

PWM signal logic 2 (solar):

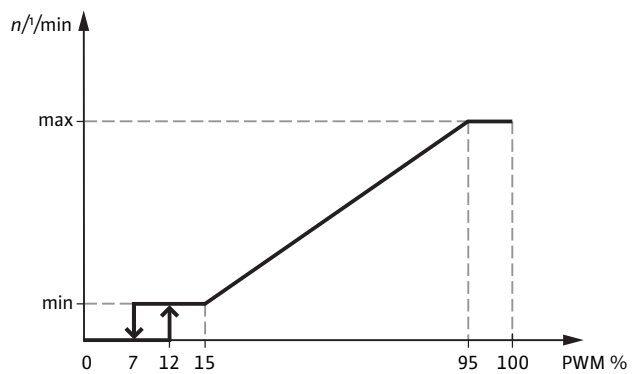

PWM input signal [%]

- < 7 Pump stops (Standby)
 - 7-15 Pump runs at minimum speed (operation)
 - 12-15 Pump runs at minimum speed (start-up)
 - 15-95 Pump speed increases linearly from minimum to maximum
 - > 95 Pump runs at maximum speed
- Signal frequency: 100 Hz–5000 Hz (1000 Hz nominal)
 Signal amplitude: 5 V–15 V (min. power 5 mA)
 Signal polarity: none

Manual control panel

Control button

The control mode and the differential pressure setpoint at $\Delta p-c$ for constant differential pressure and at $\Delta p-v$ for variable differential pressure can be set with the control button. The important basic functions can be set easily and safely, directly at the pump. Depending on customer wishes, a pre-setting of the control mode/setpoint can be done at the factory.



Local setting of the constant differential pressure setpoint at $\Delta p-c$ at the pump



Local setting of the variable differential pressure setpoint at $\Delta p-v$ at the pump



Power adjustment with a remote controller via 0-10V or PWM signal

Electrical connection

To ensure a safe and easy electrical connection, the Wilo-Stratos PARA pumps are equipped with a mains cable or, depending on the available functions, with a mains and control cable as standard.

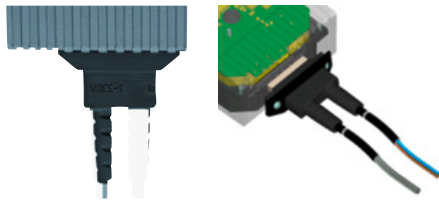

The cable is inseparable connected to the Stratos PARA pumps with a Wilo plug for Stratos PARA/-Z... 1-8; 1-11; 1-12.

Directly fixed at the electronic board of the Wilo-Stratos PARA.../ 1-7; 1-11.5:

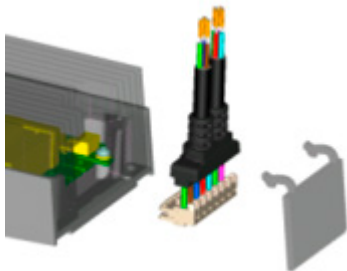

Mains connection

3-core cable

For mains power supply 1~230 V/50 Hz

black/brown: L1, 1~230 V/50 Hz
blue: Neutral N
yellow/green: Earth conductor

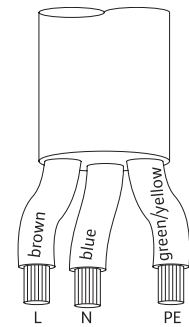

Control cables

Control via analog signal 0...10V (2-core cable or 4-core cable)

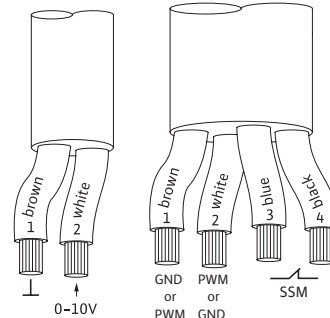

Core no. 1 (brown): GND (signal ground)
Core no. 2 (white): 0-10V (signal)
Core no. 3 (blue): SSM (if available)
Core no. 4 (black): SSM (if available)

Note:

To ensure interference resistance, the total length of the 0-10V control cable must not exceed 15 m.

Control via PWM (2-core cable or 4-core cable)

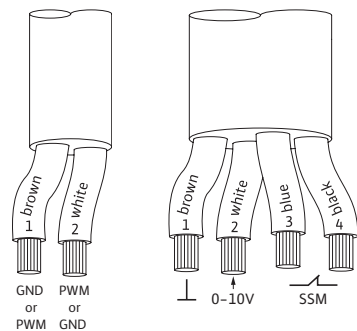

Core no. 1 (brown): PWM signal ground (GND) or PWM signal
Core no. 2 (white): PWM signal or PWM signal ground (GND)
Core no. 3 (blue): SSM (if available)
Core no. 4 (black): SSM (if available)

Note:

To ensure interference resistance, the total length of the PWM control cable must not exceed 3 m.

Available cable versions

Pump type		
	Stratos PARA /1-7 Stratos PARA /1-9 Stratos PARA /1-11.5	Stratos PARA /1-8 Stratos PARA /1-11 Stratos PARA /1-12 Stratos PARA Z /1-8 Stratos PARA Z /1-11 Stratos PARA Z /1-12
Mains cable		
Standard	- 1.5 m with end splices	- 1.5 m with end splices
Optional	- 2.2 m cable with end splices	- 2.2 m cable with end splices
	- 3.2 m cable with end	- 3.0 m cable with end splices
	- 0.1 m with Wilo OEM plug	- 0.1 m with Wilo OEM plug
	- According to customer specification	- According to customer specification
Mains and 2-core control cable		
Standard	- 1.5 m with end splices	- 1.5 m with end splices
Optional	- According to customer specification	- According to customer specification
Mains and 4-core control cable		
Standard	- 1.5 m with end splices	- 1.5 m with end splices
Optional	- 2.2 m cable with end splices	- 2.2 m cable with end splices
	- 3.2 m cable with end	- 3.2 m cable with end splices
	- 0.2 m with Wilo OEM plug	- 0.2 m with Wilo OEM plug
	- According to customer specification	- According to customer specification

Standard mains and control cable with end splices

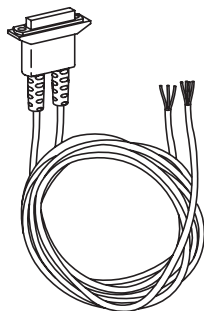

Mains and control cable with Wilo OEM plug

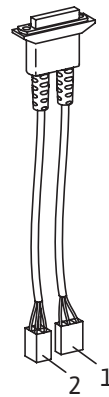

Pos. 1: Mains plug with female connector
 Pos. 2: 4-pole control plug with pins

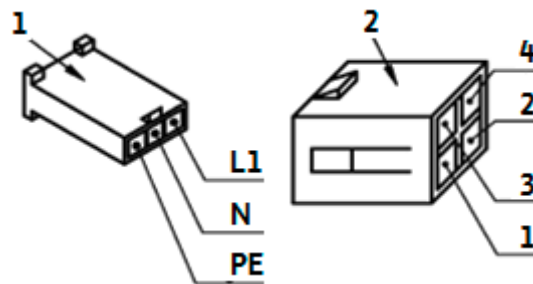

Assignment:
 L1: brown
 N: blue
 PE: yellow/green

Assignment:
 1: blue
 2: white
 3: black
 4: brown

Collective fault signal, SSM

A collective fault signal is available as potential-free contact, designed as NC contact in accordance with VDI 3814.

Contact load:

- Permitted minimum: 12 V DC, 10 mA,
- Permitted maximum: 250 V AC, 1 A.

The contact is closed under the following conditions:

- The pump is without current
- There is no fault
- Total failure of the control module

The contact is open under the following conditions:

- The pump is powered and there is one of the following faults:
 - Excess motor temperature
 - Excess control module temperature
 - Excess current
 - Pump blockage
 - Short circuit and earth leakage
 - Faulty contact between motor/control module
 - Mains undervoltage
 - Mains overvoltage
 - Electronics faults

Designation, name plate of the Wilo-Stratos PARA/-Z series

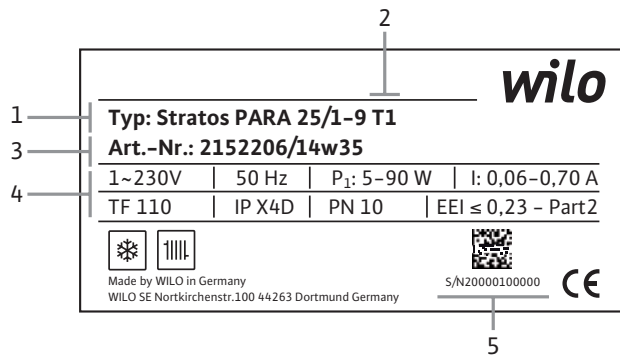

- 1 Pump type
- 2 Type no. of equipment/functions combination
- 3 Article numbers/production date (year/week)
- 4 Voltage/frequency/power consumption/electricity/ max. fluidtemperature/protection class IP/operating pressure PN/Energy efficiency index (EEI)
- 5 Serial number

Permitted installation positions Wilo-Stratos PARA 1-8/1-11/1-12 (including Z series)

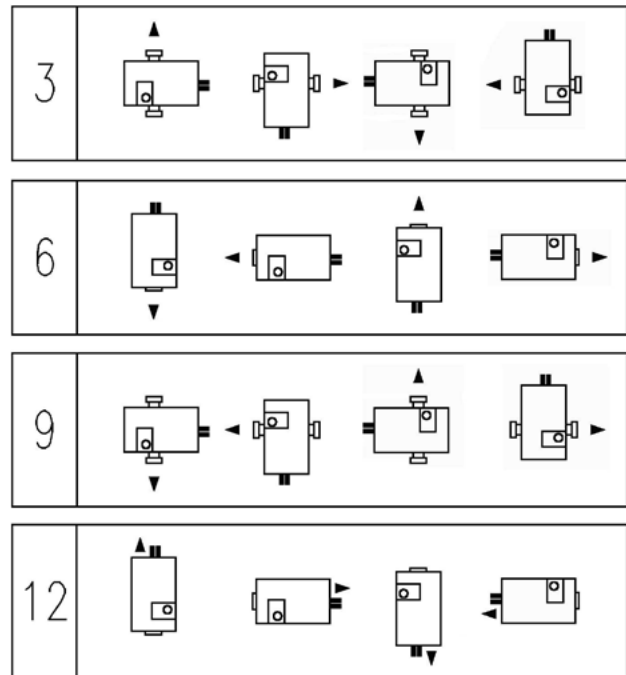

3, 6, 9 and 12 o'clock are the module positions for the indicated direction of flow at the pump housing.

Transport and interim storage

Immediately after receiving check the product for damage in transit.

Transport conditions

The device must not be exposed to temperatures outside the range of -40° C up to +85° C The transport conditions must be applied max. three months

Storage conditions

The device must not be exposed to temperatures outside the range 0° C up to +40° C. The storage time can be up to two years. The remaining water, in case of customer production tests, cannot lead to frost damages.

Variant key, pump control																											
Type of pump	Wilco-Stratos PARA (P ₂ = 25–200 W)																										
Combination N° "T"	1	2	3	6	8	10	11	12	13	16	17	18	19	20	21	22	24	26	27	28							
Operating modes																											
Control mode (n=constant)	•	•		•	•	•	•	•	•	•	•	•	•	•	•	•	•	•	•	•	•	•	•	•	•	•	•
Δp-c for constant differential pressure	•	•	•																								
Δp-v for variable differential pressure	•	•	•																								
External control functions																											
Control input "Analog In 0 ... 10 V" with cable break function	•			•																							
Control input "Analog In 0 ... 10 V" without cable break function		•				•																					
Control input PWM 1							•		•																		
Control input PWM 2								•		•																	
Signal and display functions																											
Collective fault signal SSM (floating NC contact)	•	•		•	•																						
Reaction of pump if push button set on Ext. In position																											
Pump turn with min speed	•			•	•																						
Pump turn with max speed							•		•																		
Pump stops		•			•		•		•																		
Equipment																											
Rotating button	•	•	•																								
Power cable	•	•	•	•	•	•	•	•	•	•	•	•	•	•	•	•	•	•	•	•	•	•	•	•	•	•	•
4-wire cable for 0-10 V and SSM/SBM	•	•		•	•																						
4-wire cable for PWM and SSM/SBM									•	•																	
2-wire cable for PWM/0-10V							•	•																			

• – equipped with



Heating, air-conditioning, cooling

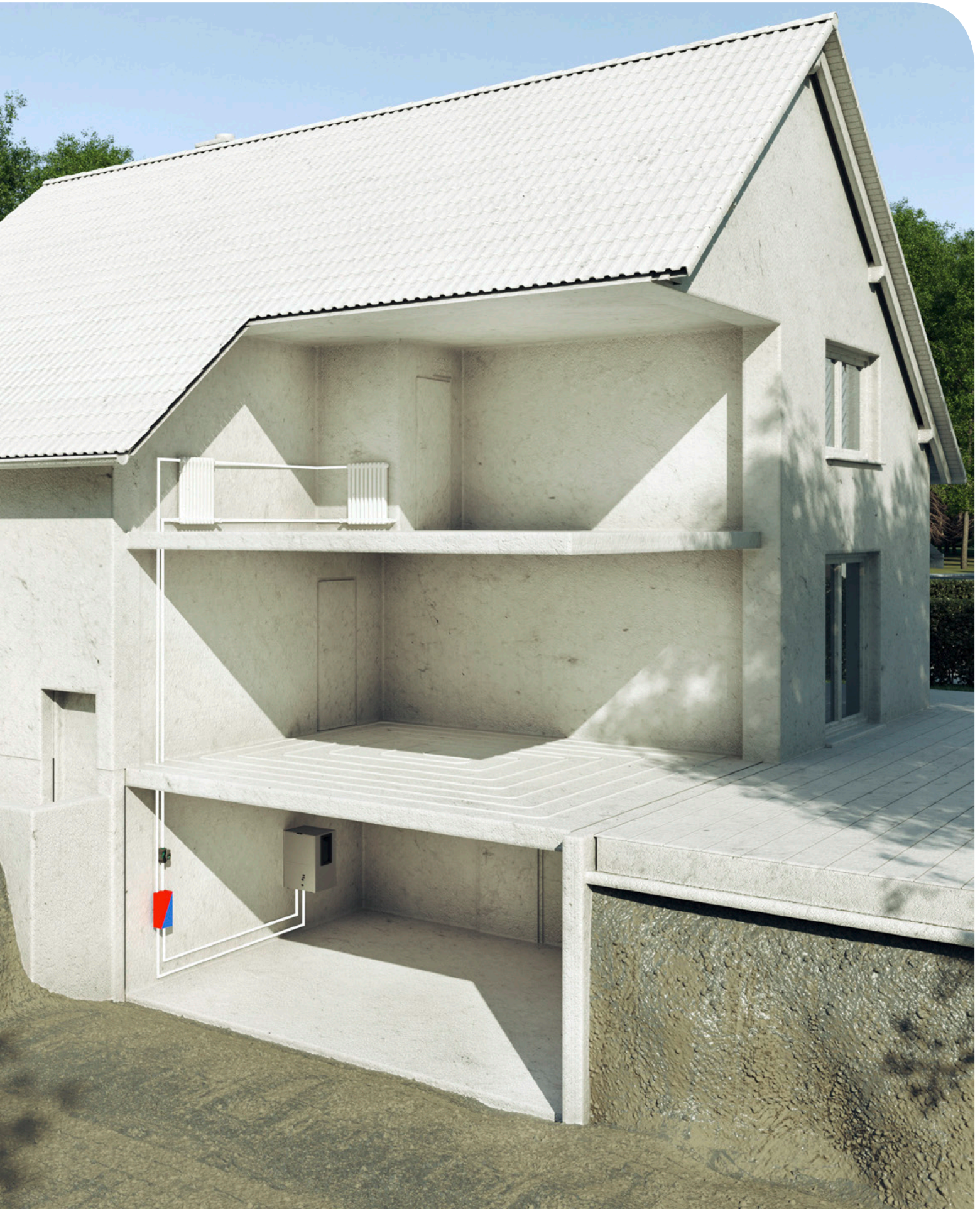



Wilo-Para



Glandless circulation pump with a cast iron pump housing and threaded connection. EC motor with automatic power adjustment and self-protecting modes.

- Self-controlled pump (operating button) or externally controlled (iPWM1 or LIN bus)
- Unique LED user interface
- Self-protecting modes
- Designed for optimised integration

Type	Page
Wilo-Para	35
Wilo-Para RSB	44
Wilo-Para KU	49
Wilo-Para RSL KU	55
Wilo-Para BSL	61
Wilo-Para KSL	67
Wilo-Para MSL	74
Wilo-Para NFSL	81
Wilo-Para HU	87



Wilo-Para STG



Glandless circulation pump with a cast iron pump housing and corrosion-protected motor housing and screws. EC motor with automatic power adjustment and self-protecting modes. The one fits all solution which keeps your business running!

- One product for all applications
- Self-controlled pump (operating button) or externally controlled (iPWM1 and iPWM2 signal)
- Green operating button for convenient settings
- LED user interface
- Manual air-venting routine and re-start function
- Reset to factory settings

Type	Page
Wilo-Para STG	98



Wilo-Yonos PARA High Flow



Glandless circulation pump with cast iron pump housing and threaded connection. EC-motor with automatic power adjustment.

Type	Page
Wilo-Yonos PARA High Flow 25/7, 30/7	102
Wilo-Yonos PARA High Flow 25/10, 30/10	104
Wilo-Yonos PARA High Flow 25/12, 30/12	106



Wilo-Stratos PARA



Glandless circulator with screwed connection. EC motor with automatic power adjustment. Supplied as standard with cable for easy electrical connection.

Type	Page
Wilo-Stratos PARA 25/1-8, 30/1-8	108
Wilo-Stratos PARA 25/1-11, 30/1-11	112
Wilo-Stratos PARA 25/1-12, 30/1-12	116

Technical data					
Type	Wilo-...				
	Para 15/4 SC	Para 15/6 SC Para 25/6 SC Para 30/6 SC	Para 15/7 SC Para 25/7 SC Para 30/7 SC	Para 15/8 SC Para 25/8 SC Para 30/8 SC	Para 25/9 SC
Operating modes					
Manual control mode (n=constant)	Operating button	Operating button	Operating button	Operating button	Operating button
Δp-c for constant differential pressure	✓	✓	✓	✓	✓
Δp-v for variable differential pressure	✓	✓	✓	✓	✓
Manual functions					
Operating mode setting	✓	✓	✓	✓	✓
Differential-pressure setpoint setting	✓	✓	✓	✓	✓
Automatic functions					
Infinitely variable power adjustment depending on the operating mode	-	-	-	-	-
Manual Deblocking function	✓	✓	✓	✓	✓
Soft start	✓	✓	✓	✓	✓
Full motor protection with integrated trip electronics	✓	✓	✓	✓	✓
Venting routine	✓	✓	✓	✓	✓
External control functions					
Control input "Analog In 0 ... 10 V" with cable break function (remote speed adjustment)	-	-	-	-	-
Control input "Analog In 0 ... 10 V" without cable break function (remote setpoint adjustment)	-	-	-	-	-
Control input PWM or LIN	-	-	-	-	-
Signal and display functions					
Collective fault signal	-	-	-	-	-
Equipment/scope of delivery					
Operating button	✓	✓	✓	✓	✓
Version without operating button (=external control)	-	-	-	-	-
Wrench attachment point on pump body	-	-	-	-	-
Including power cable	on request	on request	on request	on request	on request
Including power plug	✓	✓	✓	✓	✓
Including control cable	-	-	-	-	-
Including seals for threaded connection (loose)	on request	on request	on request	on request	on request
Including installation and operating instructions	on request	on request	on request	on request	on request
Including thermal insulation	on request	on request	on request	on request	on request
Incl. Cooling-Shell for cooling	on request	on request	on request	on request	on request
Individual packaging	on request	on request	on request	on request	on request
Collective packaging	✓	✓	✓	✓	✓
✓ = equipped with - = not equipped with					

Technical data					
Type	Para 15/4 iPWM1	Para 15/6 iPWM1 or LIN Para 25/6 iPWM1 or LIN Para 30/6 iPWM1 or LIN	Para 15/7 iPWM1 or LIN Para 25/7 iPWM1 or LIN Para 30/7 iPWM1 or LIN	Para 15/8 iPWM1 or LIN Para 25/8 iPWM1 or LIN Para 30/8 iPWM1 or LIN	Para 25/9 iPWM1
Operating modes					
Manual control mode (n=constant)	via PWM	via PWM / LIN	via PWM / LIN	via PWM / LIN	via PWM
Δp-c for constant differential pressure	-	-	-	-	-
Δp-v for variable differential pressure	-	-	-	-	-
Manual functions					
Operating mode setting	-	-	-	-	-
Differential-pressure setpoint setting	-	-	-	-	-
Automatic functions					
Infinitely variable power adjustment depending on the operating mode	✓	✓	✓	✓	✓
Manual Deblocking function	✓	✓	✓	✓	✓
Soft start	✓	✓	✓	✓	✓
Full motor protection with integrated trip electronics	✓	✓	✓	✓	✓
Venting routine	-	-	-	-	-
External control functions					
Control input "Analog In 0 ... 10 V" with cable break function (remote speed adjustment)	-	-	-	-	-
Control input "Analog In 0 ... 10 V" without cable break function (remote setpoint adjustment)	-	-	-	-	-
Control input PWM or LIN	✓	✓	✓	✓	✓
Signal and display functions					
Collective fault signal	-	-	-	-	-
Equipment/scope of delivery					
Operating button	-	-	-	-	-
Version without operating button (=external control)	✓	✓	✓	✓	✓
Wrench attachment point on pump body	-	-	-	-	-
Including power cable	on request	on request	on request	on request	on request
Including power plug	✓	✓	✓	✓	✓
Including control cable	on request	on request	on request	on request	on request
Including seals for threaded connection (loose)	on request	on request	on request	on request	on request
Including installation and operating instructions	on request	on request	on request	on request	on request
Including thermal insulation	on request	on request	on request	on request	on request
Incl. Cooling-Shell for cooling	on request	on request	on request	on request	on request
Individual packaging	on request	on request	on request	on request	on request
Collective packaging	✓	✓	✓	✓	✓
✓ = equipped with - = not equipped with					

Technical data				
Type	Wilo-...			
	Para STG 15/8 Para STG 25/8 Para STG 30/8	Yonos PARA High Flow 25/7 Yonos PARA High Flow 30/7	Yonos PARA High Flow 25/10 Yonos PARA High Flow 30/10	Yonos PARA High Flow 25/12 Yonos PARA High Flow 30/12
Operating modes				
Manual control mode (n=constant)	Operating button/ PWM	✓	✓	✓
Δp-c for constant differential pressure	✓	✓ (H _{min.} = 0.5 m, H _{max.} = 7 m)	✓ (H _{min.} = 0.5 m, H _{max.} = 10 m)	✓ (H _{min.} = 0.5 m, H _{max.} = 11 m)
Δp-v for variable differential pressure	-	✓ (H _{min.} = 2 m, H _{max.} = 7 m)	✓ (H _{min.} = 2 m, H _{max.} = 10 m)	✓ (H _{min.} = 4 m, H _{max.} = 11 m)
Manual functions				
Operating mode setting	✓	✓	✓	✓
Differential-pressure setpoint setting	-	✓	✓	✓
Automatic functions				
Infinitely variable power adjustment depending on the operating mode	✓	✓	✓	✓
Deblocking function	✓	✓	✓	✓
Soft start	✓	✓	✓	✓
Full motor protection with integrated trip electronics	✓	✓	✓	✓
Venting routine	✓	-	-	-
External control functions				
Control input "Analog In 0 ... 10 V" with cable break function (remote speed adjustment)	-	-	-	-
Control input "Analog In 0 ... 10 V" without cable break function (remote setpoint adjustment)	-	-	-	-
Control input PWM	✓	-	-	-
Signal and display functions				
Collective fault signal	-	✓	✓	✓
Equipment/scope of delivery				
Green button	✓	✓	✓	✓
Version without Green button (=external control)	-	-	-	-
Wrench attachment point on pump body	✓	✓	✓	✓
Including power cable	on request	on request	on request	on request
Including power plug	✓	on request	on request	on request
Including control cable	on request	-	-	-
Including seals for threaded connection (loose)	on request	on request	on request	on request
Including installation and operating instructions	on request	on request	on request	on request
Including thermal insulation	on request	on request	on request	on request
Incl. Cooling-Shell for cooling	on request	-	-	-
Individual packaging	on request	✓	✓	✓
Collective packaging	✓	✓	✓	✓

✓ = equipped with
- = not equipped with

Technical data			
Type	Wilo-...		
	Stratos PARA 25/1-8 Stratos PARA 30/1-8	Stratos PARA 25/1-11 Stratos PARA 30/1-11	Stratos PARA 25/1-12 Stratos PARA 30/1-12
Operating modes			
Manual control mode (n=constant)	via Analog In 0-10 V or PWM	via Analog In 0-10 V or PWM	via Analog In 0-10 V or PWM
Δp -c for constant differential pressure	$H_{min.} = 1 \text{ m}, H_{max.} = 8 \text{ m}$	$H_{min.} = 2 \text{ m}, H_{max.} = 11 \text{ m}$	$H_{min.} = 1 \text{ m}, H_{max.} = 12 \text{ m}$
Δp -v for variable differential pressure	$H_{min.} = 2 \text{ m}, H_{max.} = 8 \text{ m}$	$H_{min.} = 4 \text{ m}, H_{max.} = 11 \text{ m}$	$H_{min.} = 4 \text{ m}, H_{max.} = 12 \text{ m}$
Manual functions			
Operating mode setting	✓	✓	✓
Differential-pressure set-point setting	✓	✓	✓
Automatic functions			
Infinitely variable power adjustment depending on the operating mode	✓	✓	✓
Deblocking function	✓	✓	✓
Soft start	✓	✓	✓
Full motor protection with integrated trip electronics	✓	✓	✓
Venting routine	-	-	-
External control functions			
Control input "Analog In 0 ... 10 V" with cable break function (remote speed adjustment)	on request*	on request*	on request*
Control input "Analog In 0 ... 10 V" without cable break function (remote setpoint adjustment)	on request*	on request*	on request*
Control input PWM	on request*	on request*	on request*
Signal and display functions			
Collective fault signal	✓	✓	✓
Equipment/scope of delivery			
Green button	✓	✓	✓
Version without Green button (=external control)	✓	✓	✓
Wrench attachment point on pump body	✓	✓	✓
Including power cable	✓	✓	✓
Including power plug	-	-	-
Including control cable	on request	on request	on request
Including seals for threaded connection (loose)	on request	on request	on request
Including installation and operating instructions	on request	on request	on request
Including thermal insulation	on request	on request	on request
Incl. Cooling-Shell	on request	on request	on request
Individual packaging	✓	✓	✓
Collective packaging	on request 108 pumps/box	on request 108 pumps/box	on request 72 pumps/box

✓ = equipped with

- = not equipped with

★ = see table "possible combinations of functions and equipment"



Wilo-Para

Design

Glandless circulation pump with a cast iron or composite pump housing and threaded or clipped connection. EC motor with automatic power adjustment and self-protecting modes.

Application

Hot-water heating systems of all kinds, cooling applications

Type key

Example: **Para 15-130/7-50/SC-12**

Para Electronically controlled high-efficiency pump pump range adapted to requirements of the OEM market.

- Inline cast iron pump housing
- RSB** Cast iron axial pump housing
- KU** Composite inline pump housing
- KSL** Composite OEM pump housing
- RSL** Composite inline pump housing with venting
- MSL** Composite OEM pump housing
- NFSL** Composite OEM pump housing
- HU15** Hydraulic unit
- HU25** Hydraulic unit
- BSL** Composite OEM pump housing

15-130 Nominal diameter - Pump housing length

- Self-controlled pump (operating button) or externally controlled (iPWM or LIN bus)
- Unique LED user interface
- Self-protecting modes
- Designed for optimised integration

- 12** threading 3/4"
- 15** threading 1"
- 25** threading 1 1/2"
- 30** threading 2"

Pump housing length: 130 mm or 180 mm

7-50 Nominal delivery head range [m] -

Power consumption

SC

SC = self controlled pump

Δp -v, Δp -c, constant speed I, II, III or

iPWM1 = the pump is controlled by an external system via iPWM1 signal

LIN = the pump is controlled by an external system via Lin Bus Communication

12

Position of electronic module

Options

- External control via iPWM1 or LIN.
- Control mode Δp -c (constant), Δp -v (variable), constant speed
- Control mode selection and differential pressure setpoint setting via operating button

Type Key Example:

Technical data	
Approved fluids (other fluids on request)	
Drinking water and water for food-processing companies in accordance with TrinkwV 2001 (drinking water ordinance)	-
Power	
Energy efficiency index (EEI)	≤ 0.20
Max. delivery head H_{max}	7.7 m
Max. volume flow Q_{max}	3.5 m ³ /h
Permitted field of application	
Temperature range at max. ambient temperature	of 58°C = 0 to 100°C of 62°C = 0 to 90°C of 66°C = 0 to 80°C of 71°C = 0 to 70°C
Maximum static pressure p	10 bar
• = appropriate, - = not appropriate	

Technical data	
Electrical connection	
Mains connection	1-230 V, 50/60 Hz
Motor/electronics	
Electromagnetic compatibility	EN 61800-3
Emitted interference	EN 61000-6-3 EN 61000-6-4
Speed control	Frequency converter
Interference resistance	EN 61000-6-2 / EN 61000-6-1
Protection class	IP X4D
Insulation class	F
Minimum suction head at suction port for avoiding cavitation at water pumping temperature	
Minimum suction head at 50 / 95 °C	0.5 / 4.5 m
• = appropriate, - = not appropriate	

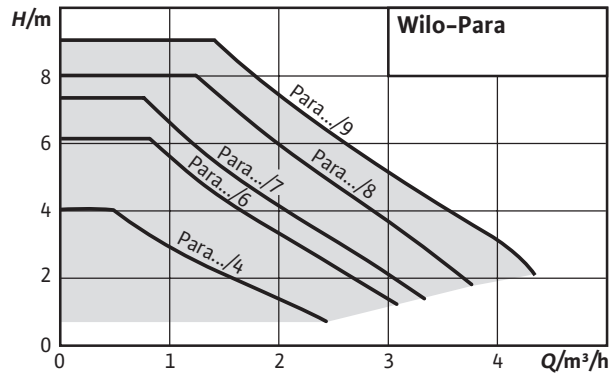

Wilo-Para



Motor data SC

Para	Speed	EEI	Power consumption 1~230 V	Current at 1~230V	Motor protection
	<i>n</i> rpm		<i>P₁</i> W	<i>I</i> A	
15-130/4-20/SC	1650 - 3300	≤ 0.20	3-20	0.04 - 0.17	integrated
25-130/4-20/SC	1650 - 3300	≤ 0.20	3-20	0.04 - 0.17	integrated
15-130/6-43/SC	2430 - 4300	≤ 0.20	3-43	0.04 - 0.44	integrated
25-130/6-43/SC	2430 - 4300	≤ 0.20	3-43	0.04 - 0.44	integrated
25-180/6-43/SC	2430 - 4300	≤ 0.20	3-43	0.04 - 0.44	integrated
30-180/6-43/SC	2430 - 4300	≤ 0.20	3-43	0.04 - 0.44	integrated
15-130/7-50/SC	2580 - 4700	≤ 0.20	6-50	0.07 - 0.44	integrated
25-130/7-50/SC	2580 - 4700	≤ 0.20	6-50	0.07 - 0.44	integrated
25-180/7-50/SC	2580 - 4700	≤ 0.20	6-50	0.07 - 0.44	integrated
30-180/7-50/SC	2580 - 4700	≤ 0.20	6-50	0.07 - 0.44	integrated
15-130/8-75/SC	3000 - 4800	≤ 0.21	10-75	0.03 - 0.66	integrated
25-130/8-75/SC	3000 - 4800	≤ 0.21	10-75	0.03 - 0.66	integrated
25-180/8-75/SC	3000 - 4800	≤ 0.21	10-75	0.03 - 0.66	integrated
30-180/8-75/SC	3000 - 4800	≤ 0.21	10-75	0.03 - 0.66	integrated
25-130/9-87/SC	2610 - 4540	≤ 0.21	13-87	0.03 - 0.66	integrated
25-180/9-87/SC	2610 - 4540	≤ 0.21	13-87	0.03 - 0.66	integrated

Motor data iPWM1/LIN					
Para	Speed	EEl	Power consumption 1~230 V	Current at 1~230V	Motor protection
	<i>n</i> rpm		P_1 W	<i>I</i> A	
15-130/4-20/IPWM1	700 - 3300	≤ 0.20	1-20	0.04 - 0.17	integrated
25-130/4-20/IPWM1	700 - 3300	≤ 0.20	1-20	0.04 - 0.17	integrated
15-130/6-43*	700 - 4300	≤ 0.20	1-43	0.04 - 0.44	integrated
25-130/6-43*	700 - 4300	≤ 0.20	1-43	0.04 - 0.44	integrated
25-180/6-43*	700 - 4300	≤ 0.20	1-43	0.04 - 0.44	integrated
30-180/6-43*	700 - 4300	≤ 0.20	1-43	0.04 - 0.44	integrated
15-130/7-50*	700 - 4700	≤ 0.20	1-50	0.02 - 0.44	integrated
25-130/7-50*	700 - 4700	≤ 0.20	1-50	0.02 - 0.44	integrated
25-180/7-50*	700 - 4700	≤ 0.20	1-50	0.02 - 0.44	integrated
30-180/7-50*	700 - 4700	≤ 0.20	1-50	0.02 - 0.44	integrated
15-130/8-75*	500 - 4800	≤ 0.21	2-75	0.03 - 0.66	integrated
25-130/8-75*	500 - 4800	≤ 0.21	2-75	0.03 - 0.66	integrated
25-180/8-75*	500 - 4800	≤ 0.21	2-75	0.03 - 0.66	integrated
30-180/8-75*	500 - 4800	≤ 0.21	2-75	0.03 - 0.66	integrated
25-130/9-87/IPWM1	500 - 4540	≤ 0.21	3-87	0.03 - 0.66	integrated
25-180/9-87/IPWM1	500 - 4540	≤ 0.21	3-87	0.03 - 0.66	integrated

*iPWM or LIN

Pump curves

$\Delta p-v$ (variable)

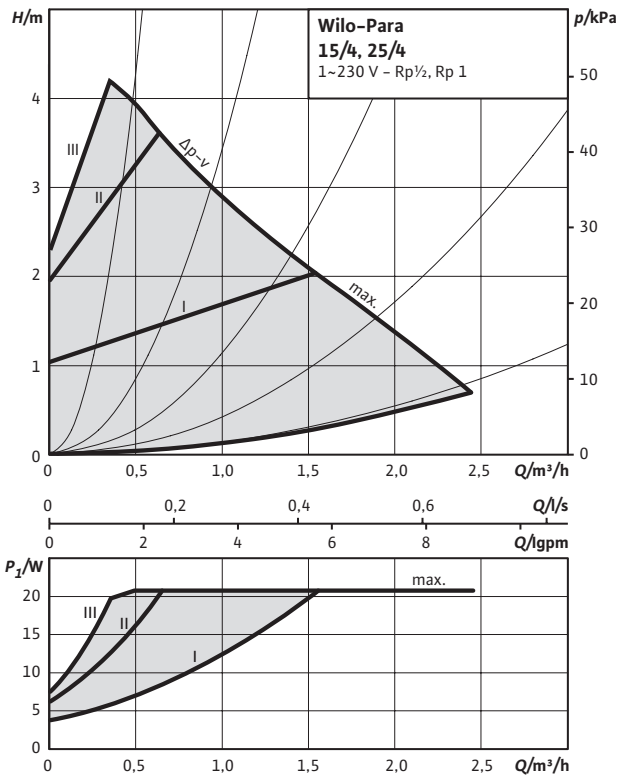

Pump curves

$\Delta p-c$ (constant)

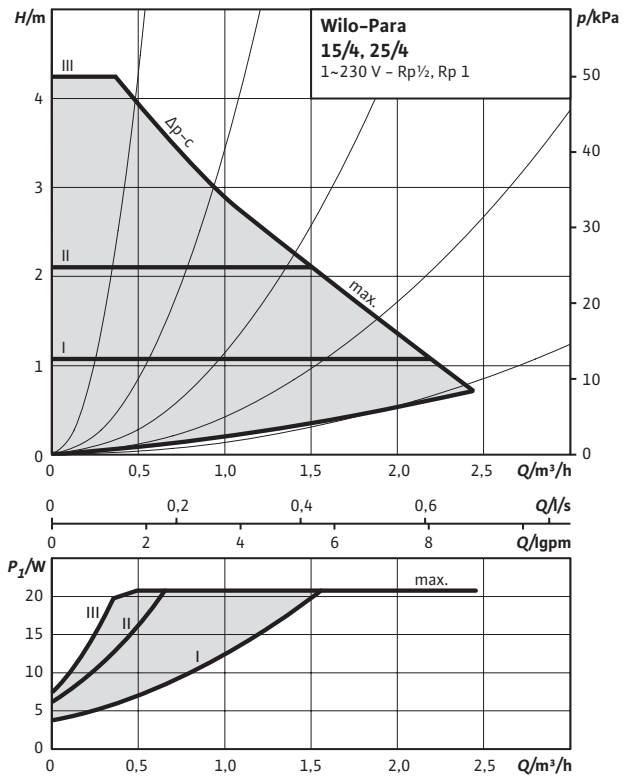

Pump curves

Constant speed I, II, III

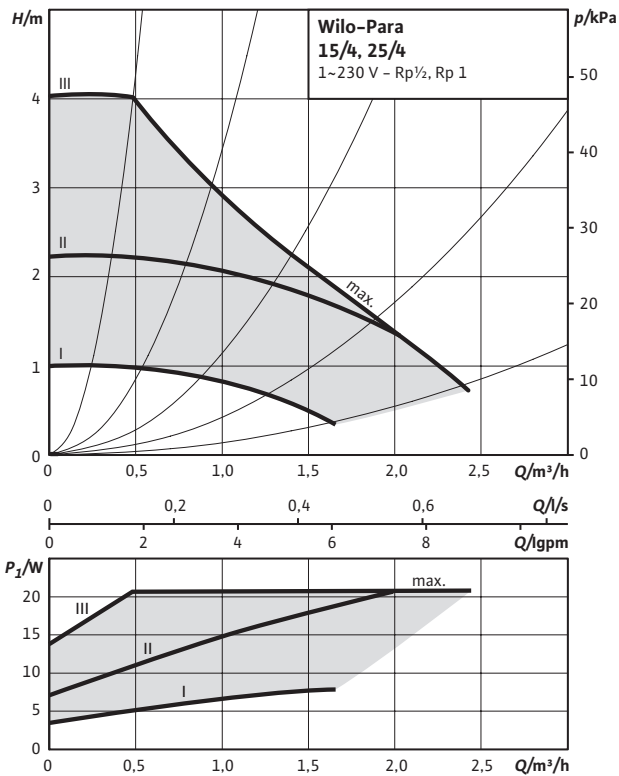

Pump curves

External control via PWM1

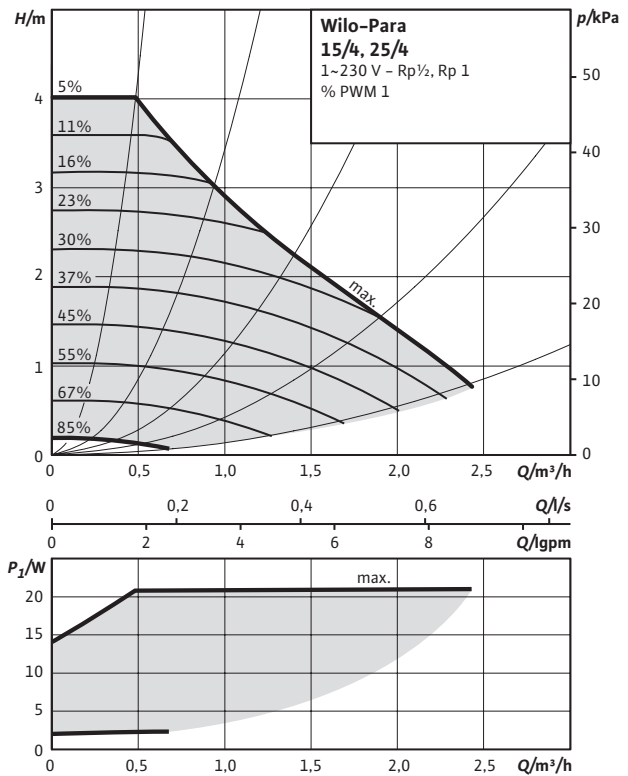

Pump curves

$\Delta p-v$ (variable)

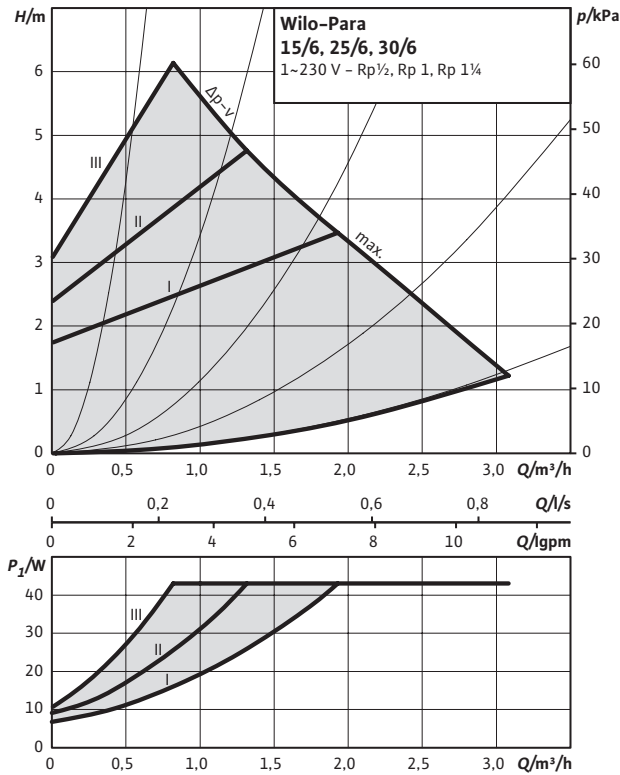

Pump curves

$\Delta p-c$ (constant)

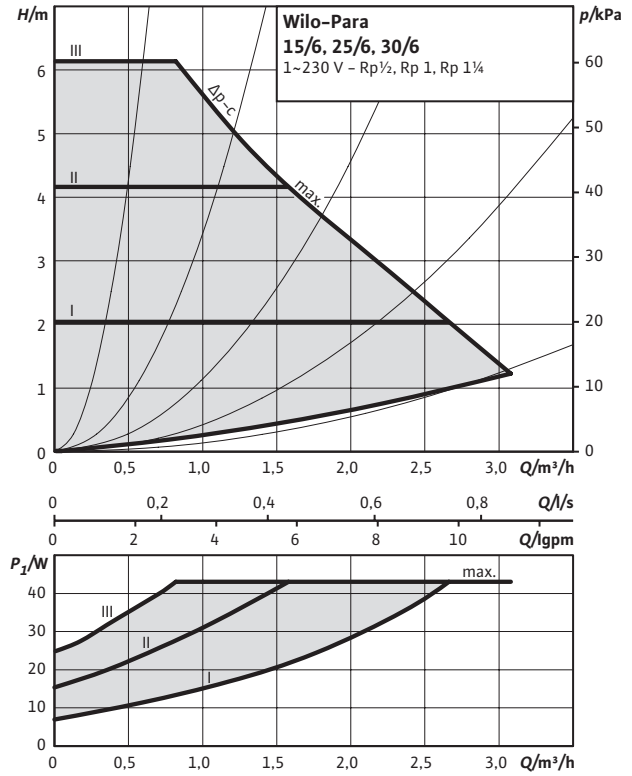

Pump curves

Constant speed I, II, III

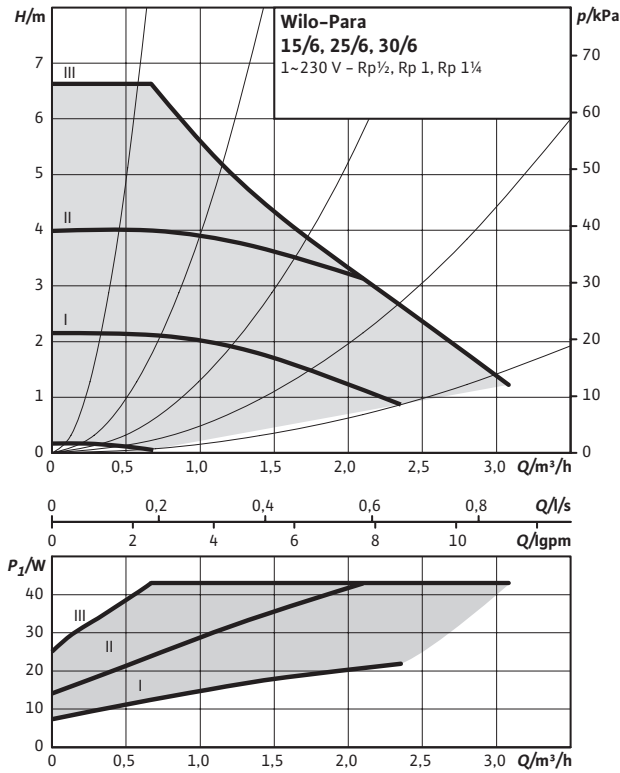

Pump curves

External control via PWM/LIN

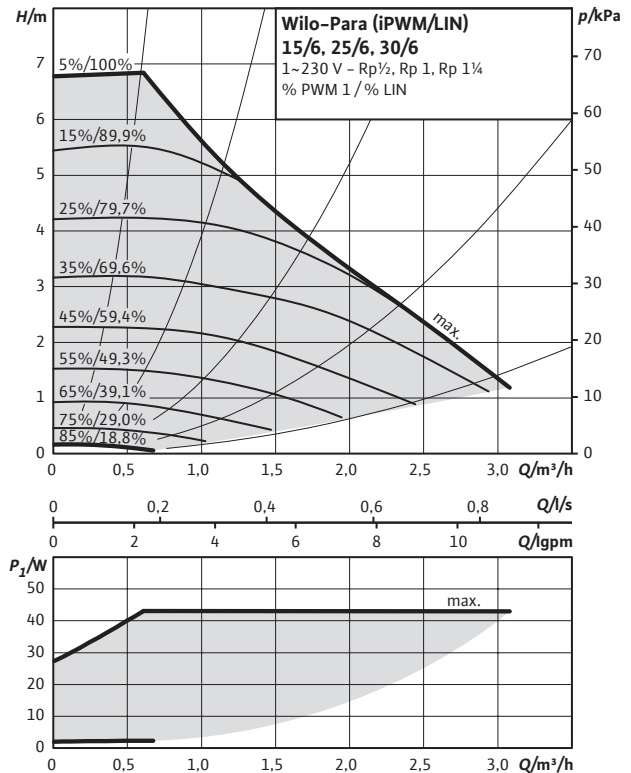

Pump curves

$\Delta p-v$ (variable)

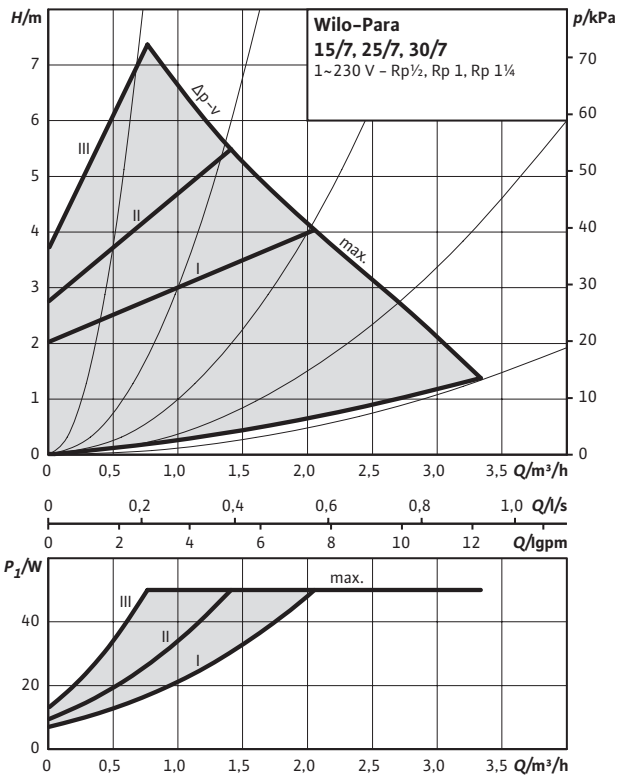

Pump curves

$\Delta p-c$ (constant)

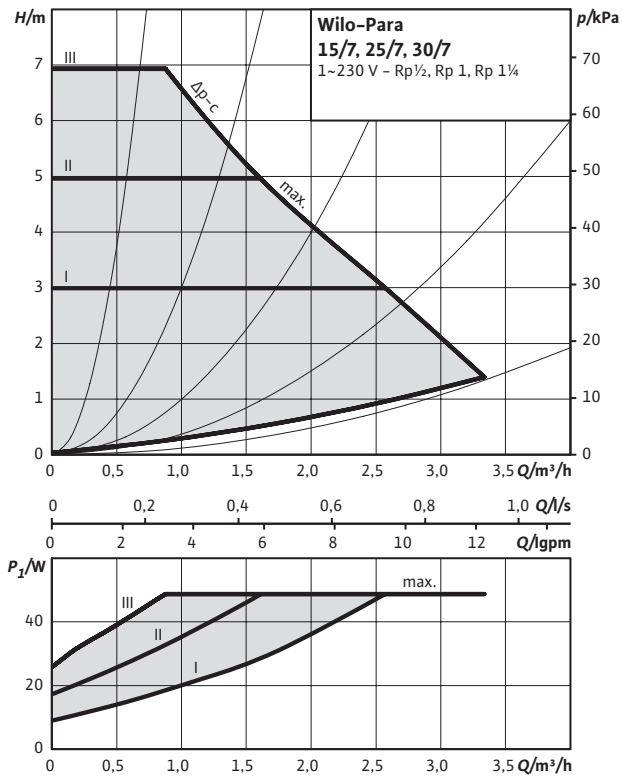

Pump curves

Constant speed I, II, III

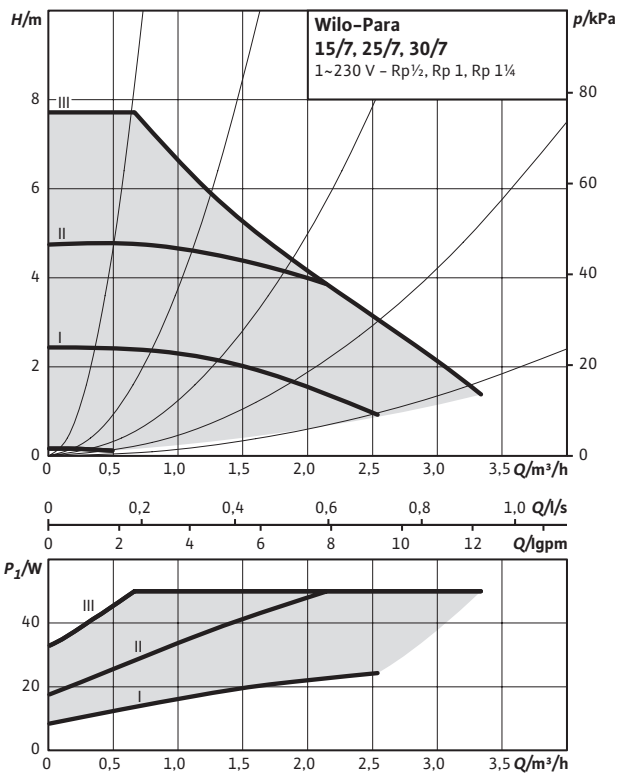

Pump curves

External control via PWM1/LIN

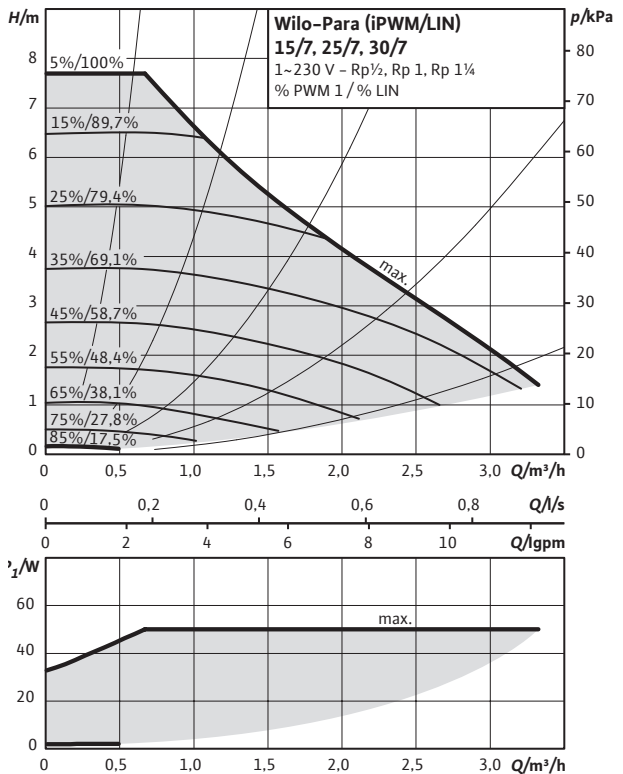

Pump curves

$\Delta p-v$ (variable)

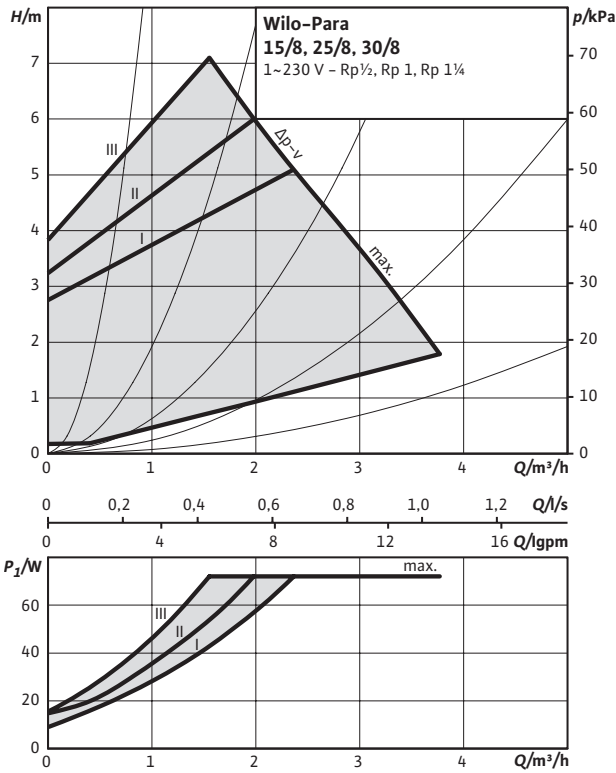

Pump curves

$\Delta p-c$ (constant)

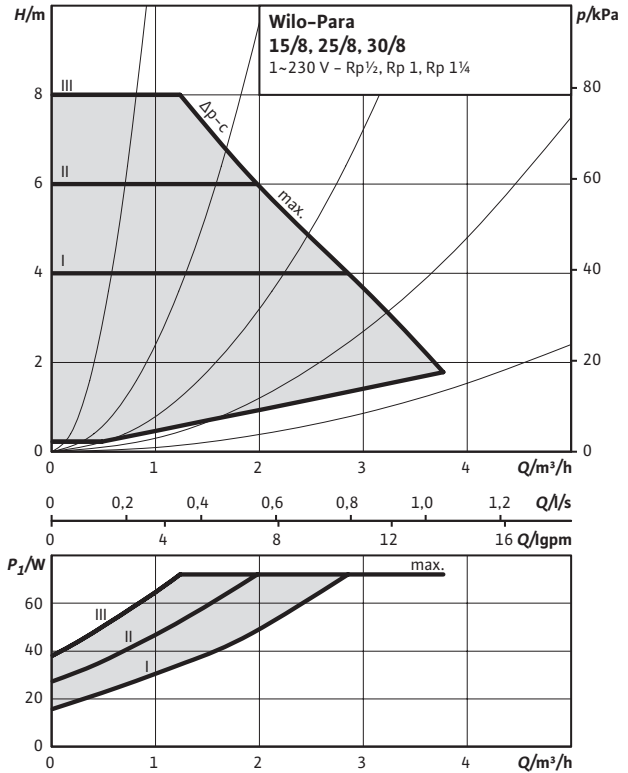

Pump curves

Constant speed I, II, III

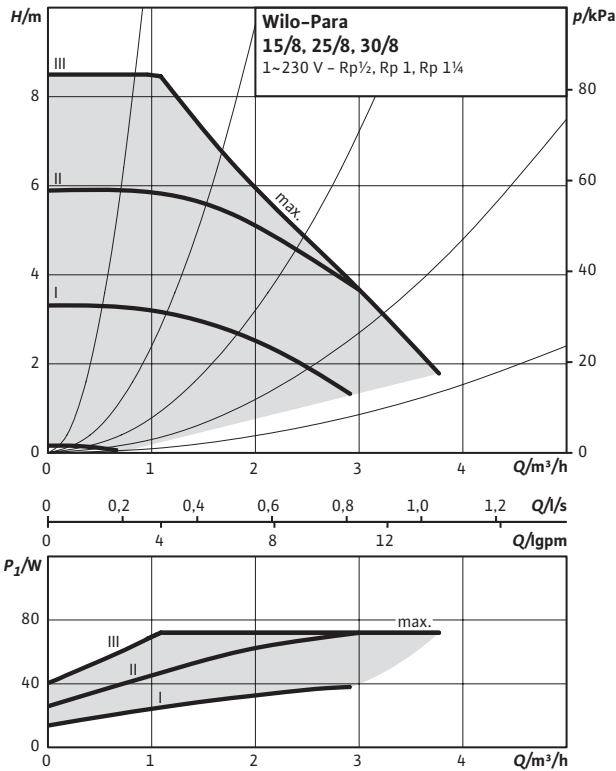

Pump curves

External control via PWM1/LIN

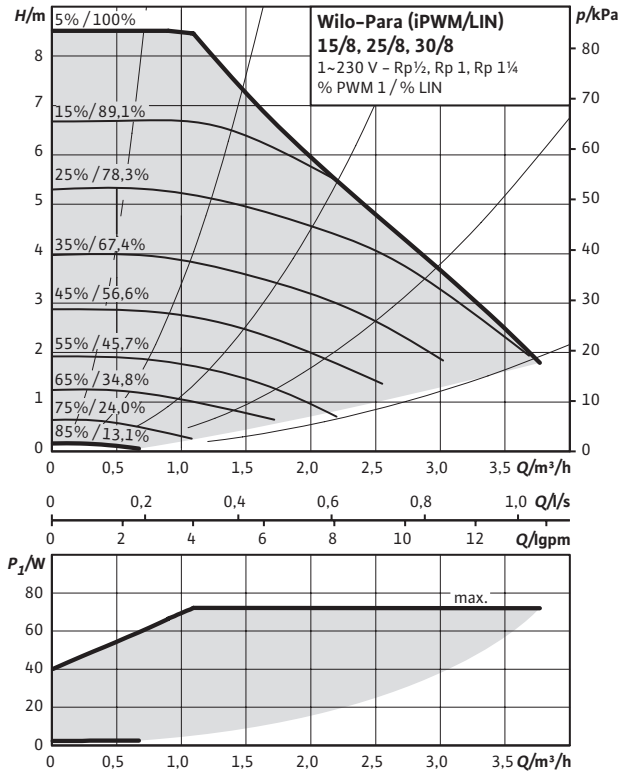

Pump curves

$\Delta p-v$ (variable)

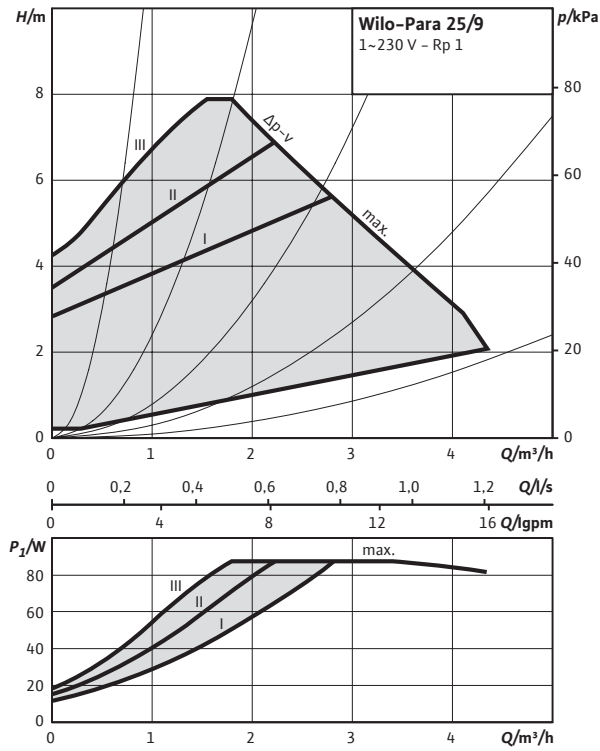

Pump curves

$\Delta p-c$ (constant)

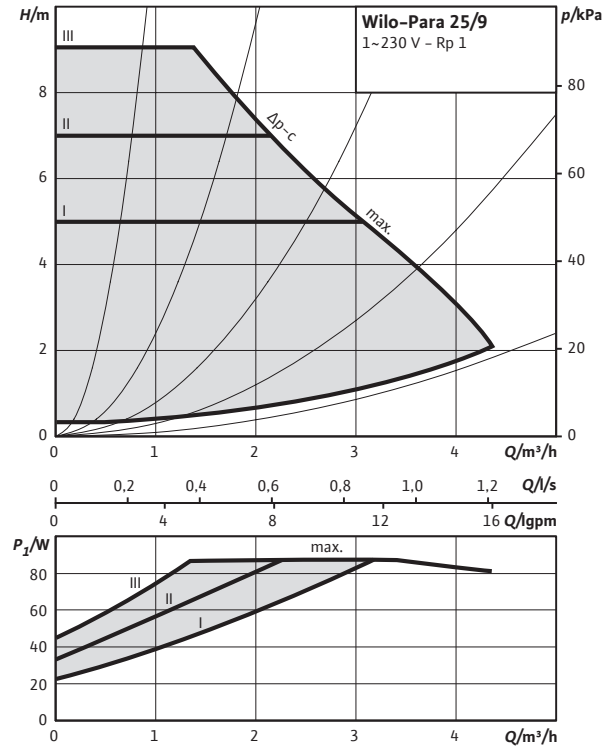

Pump curves

Constant speed I, II, III

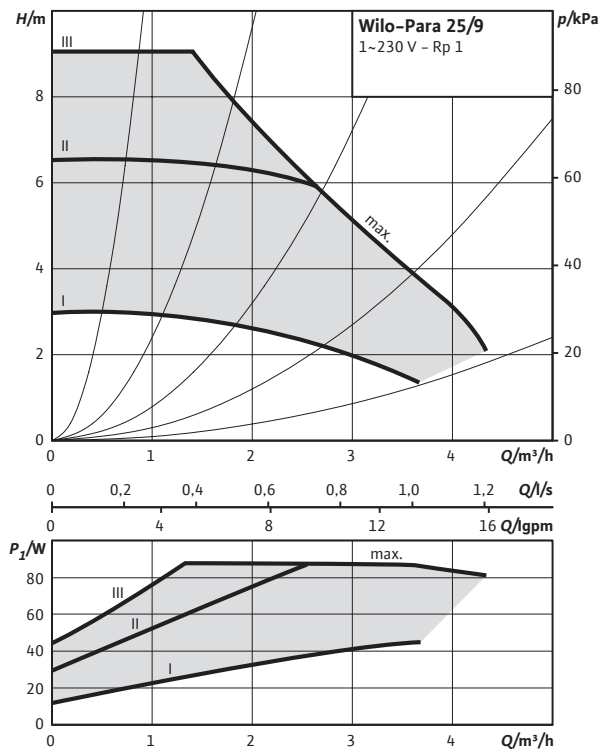

Pump curves

External control via PWM1

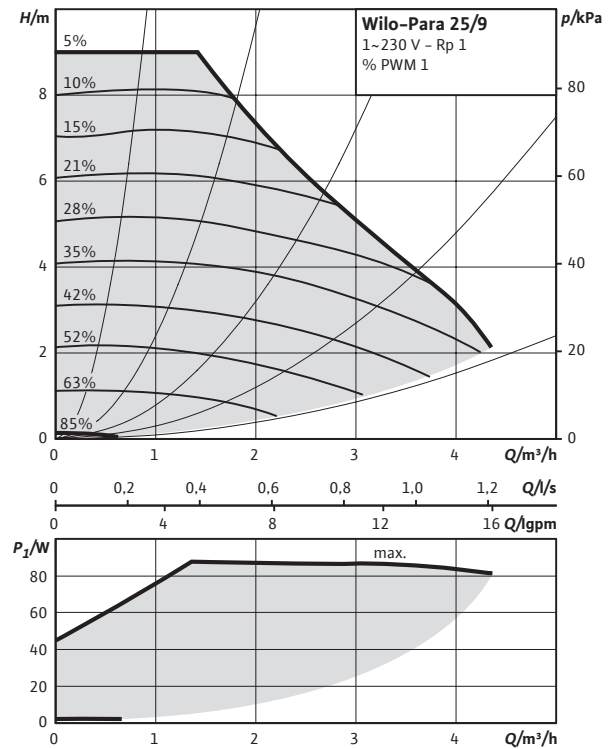

Dimension drawing SC

Wilo-Para

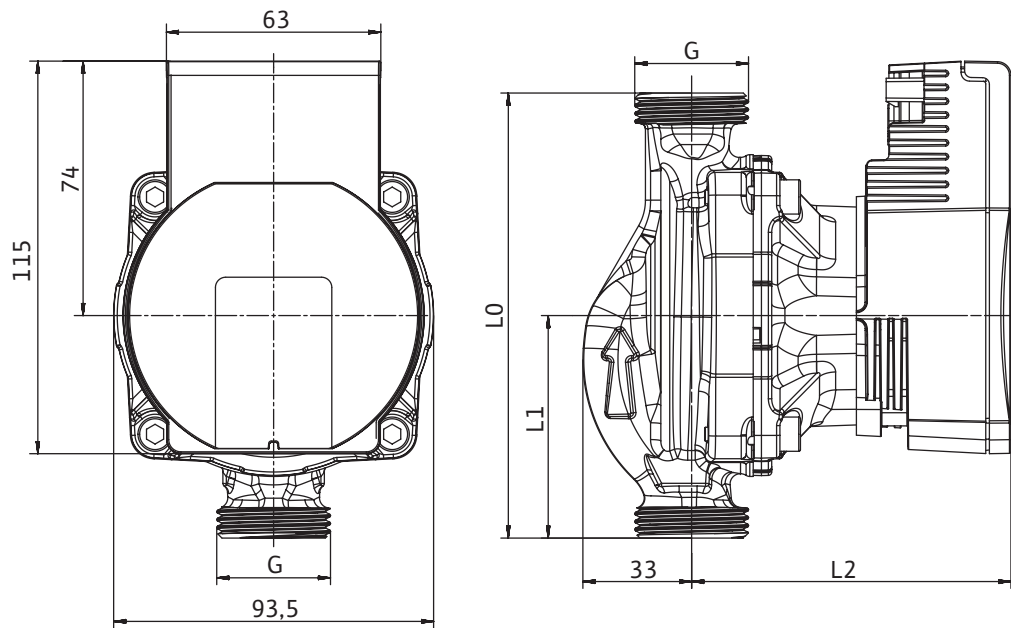

Technical data				
Designation	Para 15-130/4-20/SC	Para 15-130/6-43/SC	Para 15-130/7-50/SC	Para 15-130/8-75/SC
Threaded pipe union				Rp 1/2
Thread				G 1
Overall length l_0				130 mm
Dimensions $L1$				65 mm
Dimensions $L2$	94 mm			105 mm
Weight approx. m	1.54 kg			1.7 kg

Technical data									
Designation	Para 25-130/4-20/SC	Para 25-130/6-43/SC	Para 25-180/6-43/SC	Para 25-130/7-50/SC	Para 25-180/7-50/SC	Para 25-130/8-75/SC	Para 25-180/8-75/SC	Para 25-130/9-87/SC	Para 25-180/9-87/SC
Threaded pipe union	Rp 1								
Thread	G 1 1/2								
Overall length l_0	130 mm	180 mm	130 mm	180 mm	130 mm	180 mm	130 mm	180 mm	
Dimensions $L1$	65 mm	90 mm	65 mm	90 mm	65 mm	90 mm	65 mm	90 mm	
Dimensions $L2$	94 mm			105 mm					
Weight approx. m	1.66 kg	1.78 kg	1.66 kg	1.78 kg	1.8 kg	2 kg	2 kg	2.2 kg	

Technical data			
Designation	Para 30-180/6-43/SC	Para 30-180/7-50/SC	Para 30-180/8-75/SC
Threaded pipe union	Rp 1 1/4		
Thread	G 2		
Overall length l_0	180 mm		
Dimensions $L1$	90 mm		
Dimensions $L2$	94 mm		105 mm
Weight approx. m	1.96 kg		2.1 kg

Materials

Pump housing	Cast iron with cataphoresis treatment
Impeller	PP composite with GF 40%
Pump shaft	Stainless steel
Bearing	Carbon, metal impregnated

Dimension drawing iPWM1/LIN

Wilo-Para

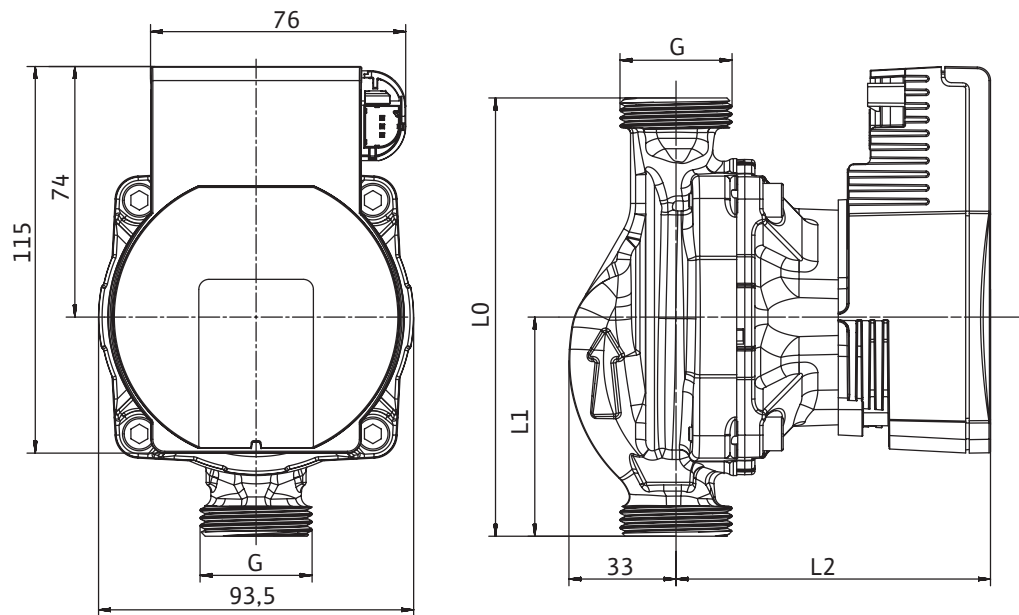

Technical data

Designation	Para 15-130/4-20/iPWM1	Para 15-130/6-43*	Para 15-130/7-50*	Para 15-130/8-75*
Threaded pipe union	Rp 1/2			
Thread	G 1			
Overall length l_0	130 mm			
Dimensions L1	65 mm			
Dimensions L2	94 mm		105 mm	
Weight approx. m	1.54 kg		1.7 kg	

Technical data

Designation	Para 25-130/4-20/iPWM1	Para 25-130/6-43*	Para 25-180/6-43*	Para 25-130/7-50*	Para 25-180/7-50*	Para 25-130/8-75*	Para 25-180/8-75*	Para 25-130/9-87/iPWM1	Para 25-180/9-87/iPWM1
Threaded pipe union	Rp 1								
Thread	G 1 1/2								
Overall length l_0	130 mm	130 mm	180 mm	130 mm	180 mm	130 mm	180 mm	130 mm	180 mm
Dimensions L1	65 mm	65 mm	90 mm	65 mm	90 mm	65 mm	90 mm	65 mm	90 mm
Dimensions L2	94 mm			105 mm					
Weight approx. m	1.66 kg	1.66 kg	1.78 kg	1.66 kg	1.78 kg	1.8 kg	2 kg	2 kg	2.2 kg

Technical data

Designation	Para 30-180/6-43*	Para 30-180/7-50*	Para 30-180/8-75*
Threaded pipe union	Rp 1 1/4		
Thread	G 2		
Overall length l_0	180 mm		
Dimensions L1	90 mm		
Dimensions L2	94 mm		105 mm
Weight approx. m	1.96 kg		2.1 kg

Materials

Pump housing	Cast iron with cataphoresis treatment
Impeller	PP composite with GF 40%
Pump shaft	Stainless steel
Bearing	Carbon, metal impregnated

*iPWM1 or LIN

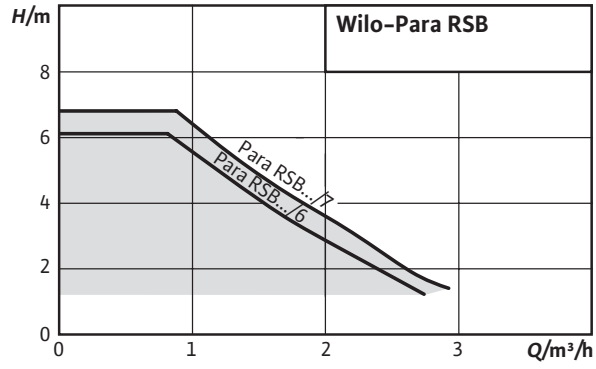

Wilo-Para RSB

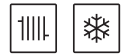

Motor data SC					
Para	Speed	EEl	Power consumption 1~230 V	Current at 1~230V	Motor protection
	<i>n</i> rpm		<i>P</i> ₁ W	<i>I</i> A	
RSB/6-43/SC	2430 - 4300	≤ 0.20	3-43	0.04 - 0.44	integrated

Motor data iPWM					
Para	Speed	EEl	Power consumption 1~230 V	Current at 1~230V	Motor protection
	<i>n</i> rpm		<i>P</i> ₁ W	<i>I</i> A	
RSB/7-50/IPWM1	700 - 4700	≤ 0.20	1-50	0.02 - 0.44	integrated

Pump curves

$\Delta p-v$ (variable)

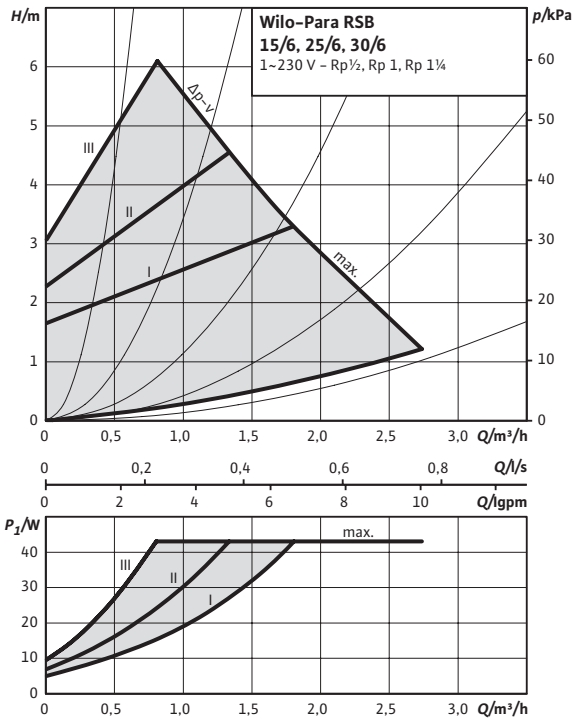

Pump curves

$\Delta p-c$ (constant)

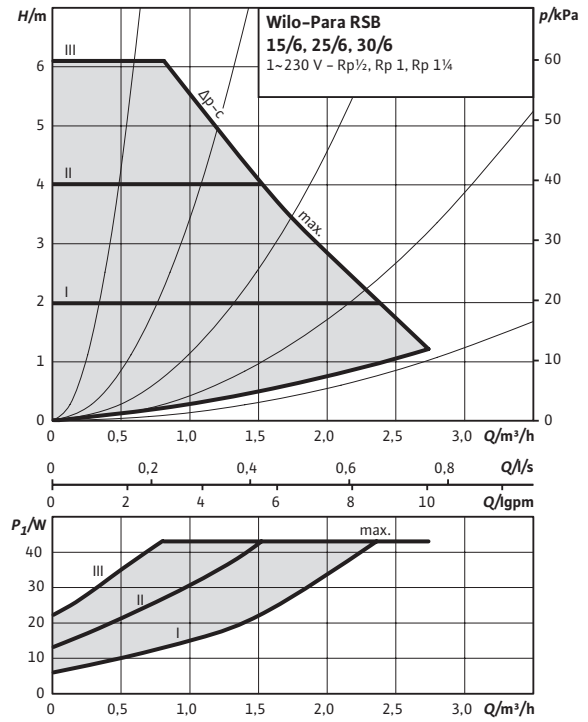

Pump curves

Constant speed I, II, III

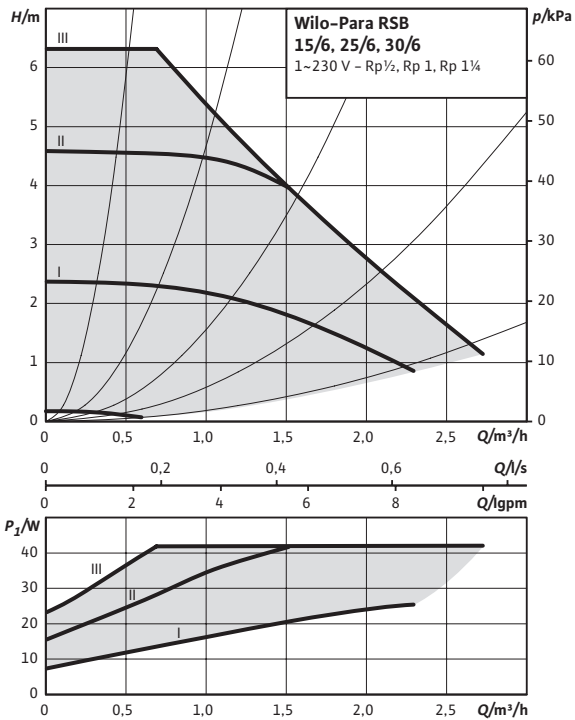

Pump curves

External control via PWM 1

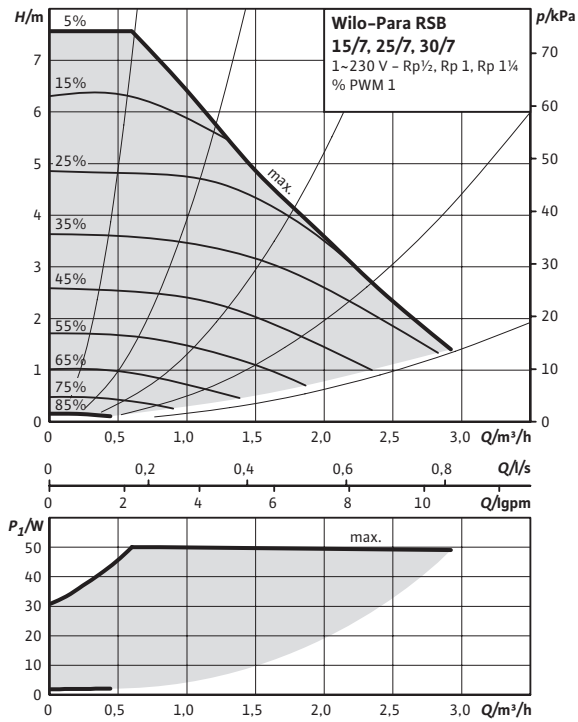

Dimension drawing SC

Wilo-Para RSB

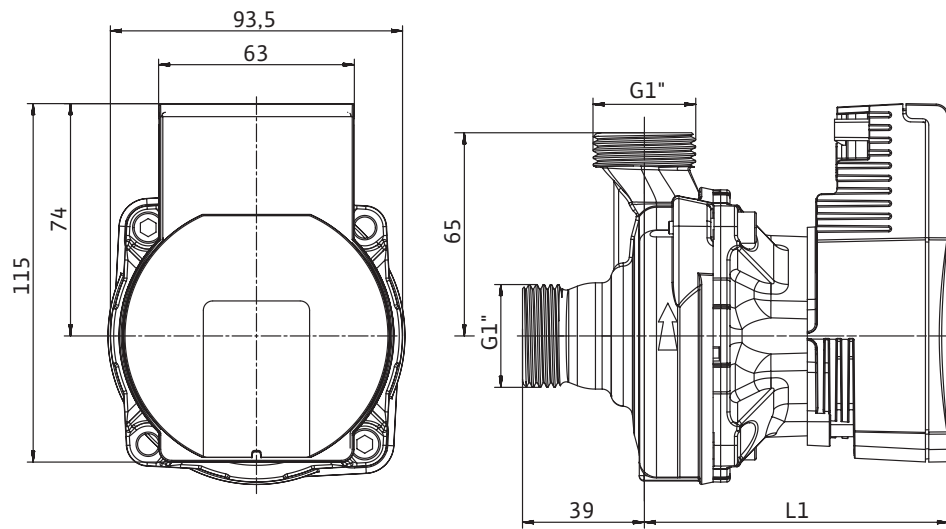

Technical data

Designation Para RSB/6-43/SC

Threaded pipe union Rp ½

Thread G 1

Weight approx. *m* 1.4 kg

Dimensions *L1* 97 mm

Materials

Pump housing Cast iron with cathaphoresis treatment

Impeller PP composite with GF 40%

Pump shaft Stainless steel

Bearing Carbon, metal impregnated

Dimension drawing iPWM1

Wilo-Para RSB

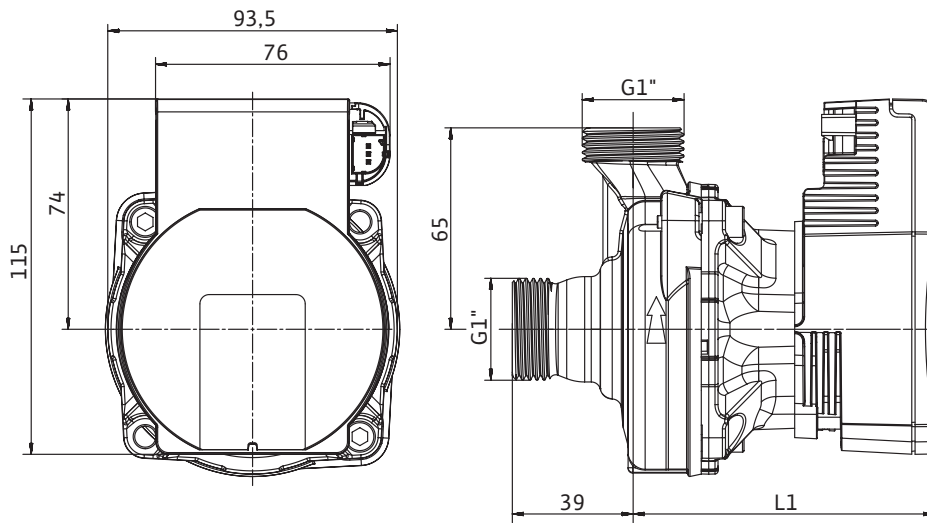

Technical data

Designation	Para RSB/7-50/iPWM1
Threaded pipe union	Rp 1/2
Thread	G 1
Weight approx. <i>m</i>	1.4 kg
Dimensions <i>L1</i>	97 mm
Materials	
Pump housing	Cast iron with cathaphoresis treatment
Impeller	PP composite with GF 40%
Pump shaft	Stainless steel
Bearing	Carbon, metal impregnated

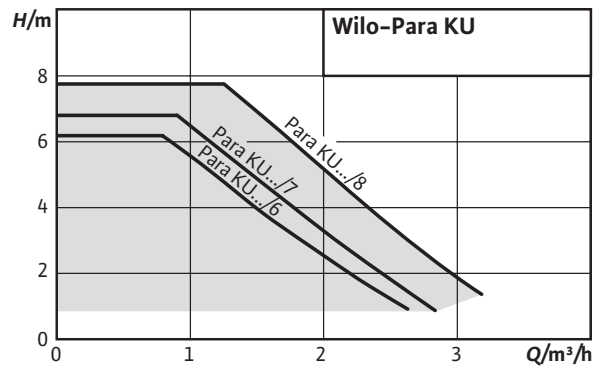

Wilo-Para KU



Motor data SC

Para	Speed	EEl	Power consumption 1~230 V	Current at 1~230V	Motor protection
	<i>n</i> rpm		<i>P</i> ₁ W	<i>I</i> A	
KU15-130/6-43/SC	2430 - 4300	≤ 0.20	3-43	0.04 - 0.44	integrated
KU20-130/6-43/SC	2430 - 4300	≤ 0.20	3-43	0.04 - 0.44	integrated
KU25-130/6-43/SC	2430 - 4300	≤ 0.20	3-43	0.04 - 0.44	integrated
KU15-130/7-50/SC	2580 - 4700	≤ 0.20	6-50	0.07 - 0.44	integrated
KU20-130/7-50/SC	2580 - 4700	≤ 0.20	6-50	0.07 - 0.44	integrated
KU25-130/7-50/SC	2580 - 4700	≤ 0.20	6-50	0.07 - 0.44	integrated
KU15-130/8-75/SC	3000 - 4800	≤ 0.21	10-75	0.03 - 0.66	integrated
KU20-130/8-75/SC	3000 - 4800	≤ 0.21	10-75	0.03 - 0.66	integrated
KU25-130/8-75/SC	3000 - 4800	≤ 0.21	10-75	0.03 - 0.66	integrated

Motor data iPWM1/LIN

Para	Speed	EEl	Power consumption 1~230 V	Current at 1~230V	Motor protection
	<i>n</i> rpm		<i>P</i> ₁ W	<i>I</i> A	
KU15-130/6-43*	700 - 4300	≤ 0.20	1-43	0.04 - 0.44	integrated
KU20-130/6-43*	700 - 4300	≤ 0.20	1-43	0.04 - 0.44	integrated
KU25-130/6-43*	700 - 4300	≤ 0.20	1-43	0.04 - 0.44	integrated
KU15-130/7-50*	700 - 4700	≤ 0.20	1-50	0.02 - 0.44	integrated
KU20-130/7-50*	700 - 4700	≤ 0.20	1-50	0.02 - 0.44	integrated
KU25-130/7-50*	700 - 4700	≤ 0.20	1-50	0.02 - 0.44	integrated
KU15-130/8-75*	500 - 4800	≤ 0.21	2-75	0.03 - 0.66	integrated
KU20-130/8-75*	500 - 4800	≤ 0.21	2-75	0.03 - 0.66	integrated
KU25-130/8-75*	500 - 4800	≤ 0.21	2-75	0.03 - 0.66	integrated

*iPWM1 or LIN

Pump curves

$\Delta p-v$ (variable)

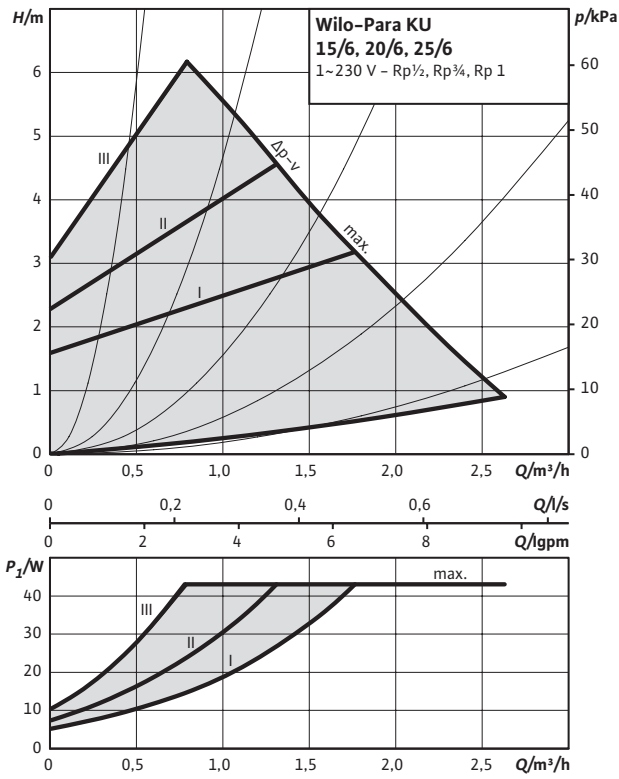

Pump curves

$\Delta p-c$ (constant)

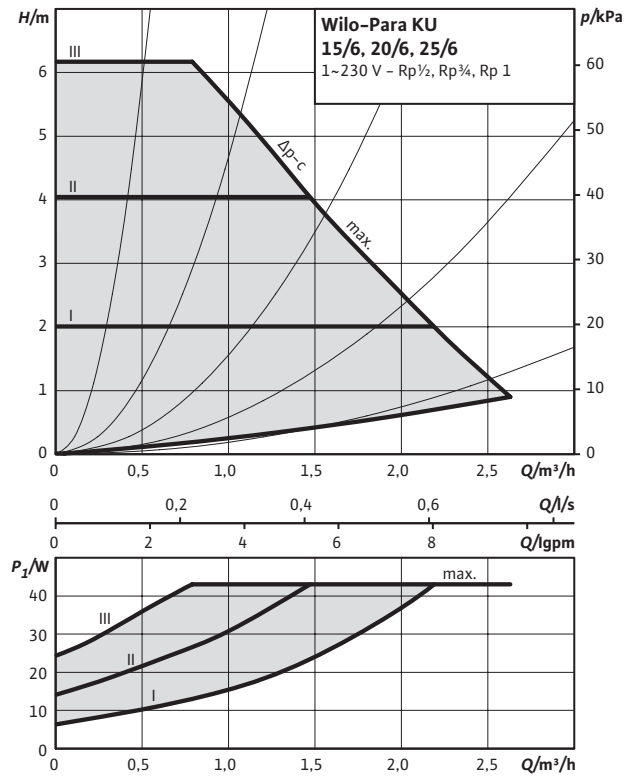

Pump curves

Constant speed I, II, III

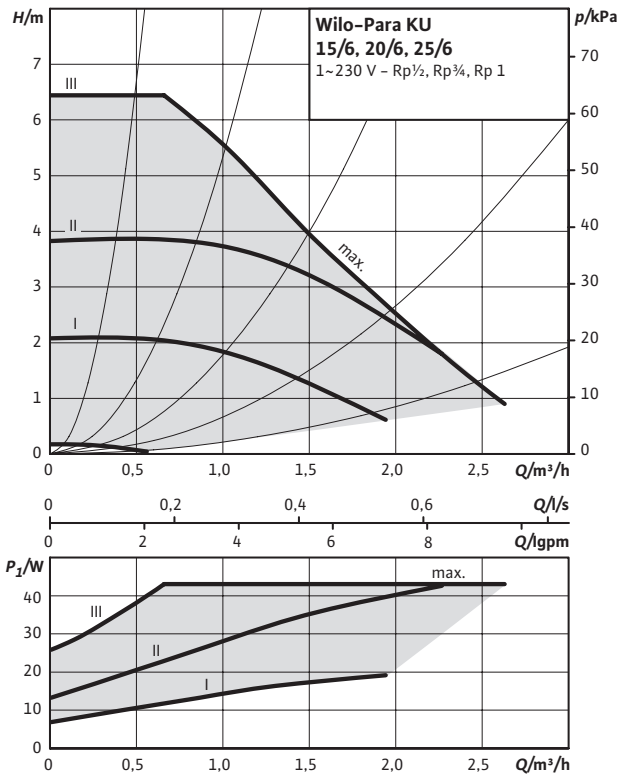

Pump curves

External control via PWM1/LIN

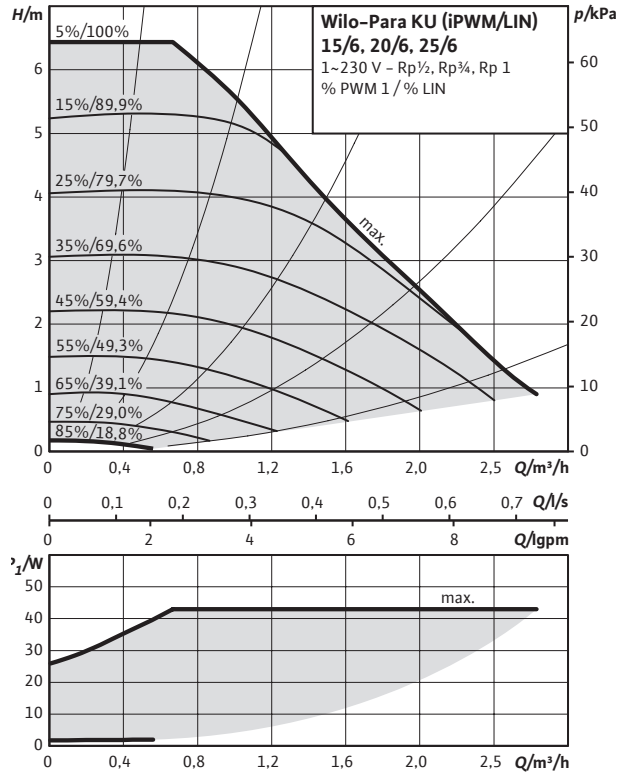

Pump curves

$\Delta p-v$ (variable)

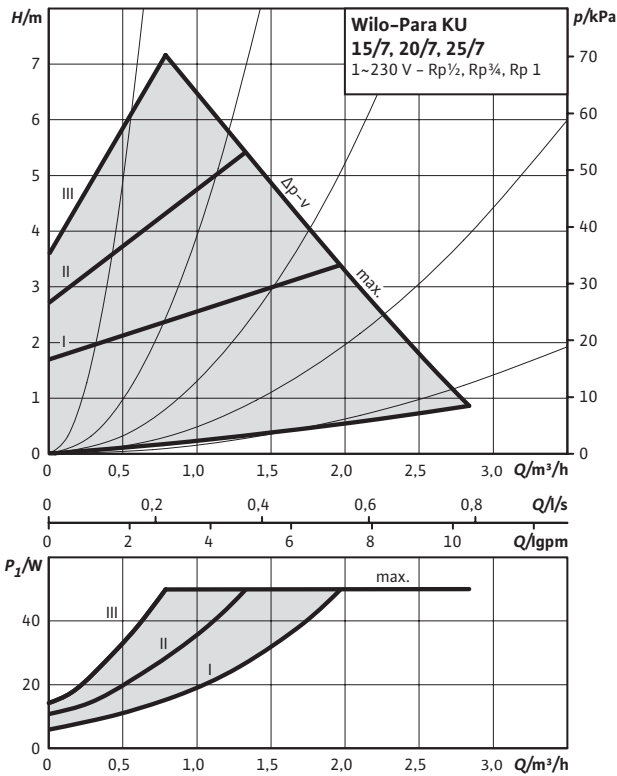

Pump curves

$\Delta p-c$ (constant)

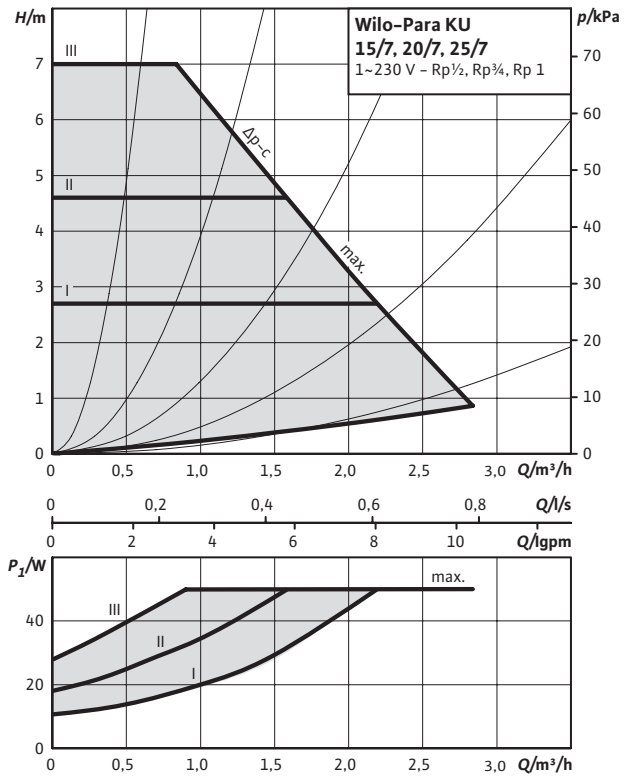

Pump curves

Constant speed I, II, III

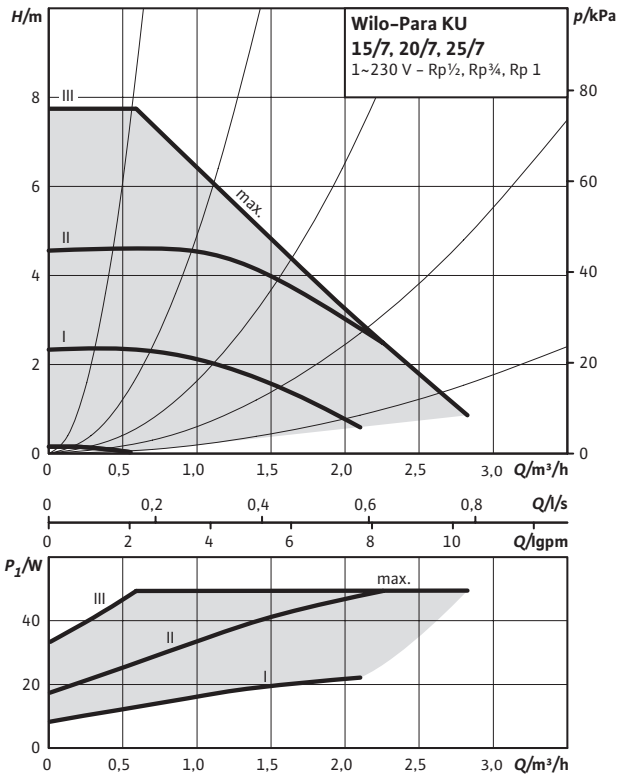

Pump curves

External control via PWM1/LIN

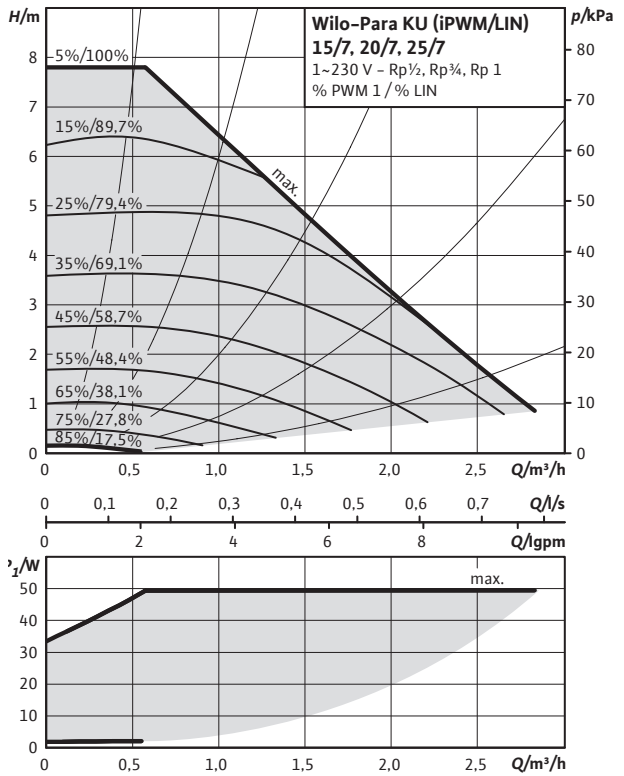

Pump curves

$\Delta p-v$ (variable)

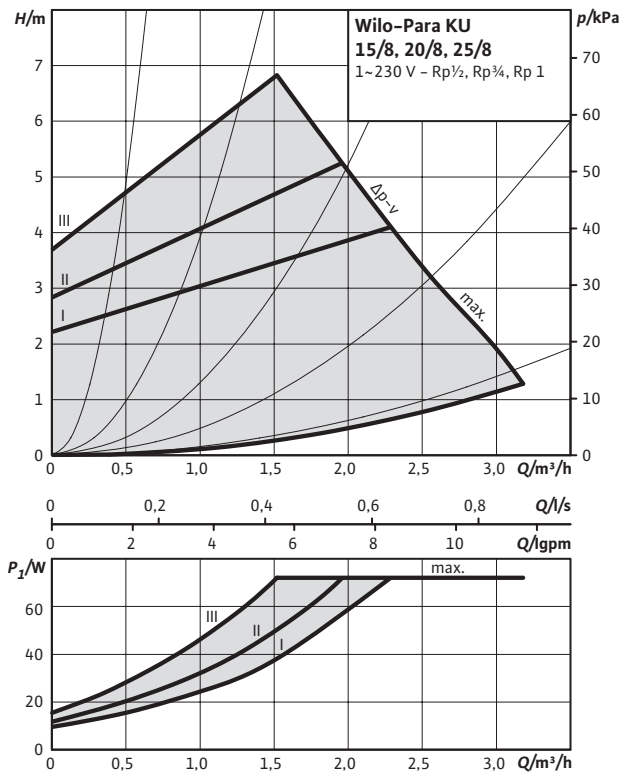

Pump curves

$\Delta p-c$ (constant)

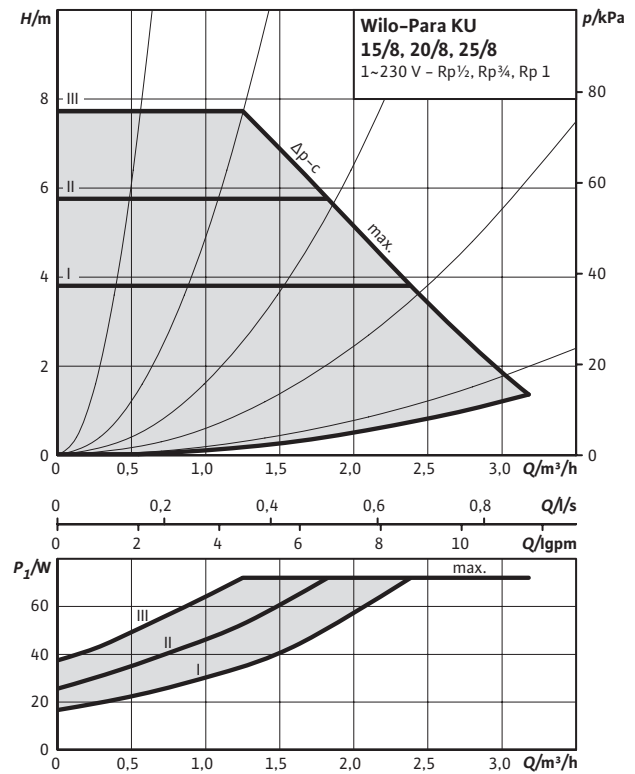

Pump curves

Constant speed I, II, III

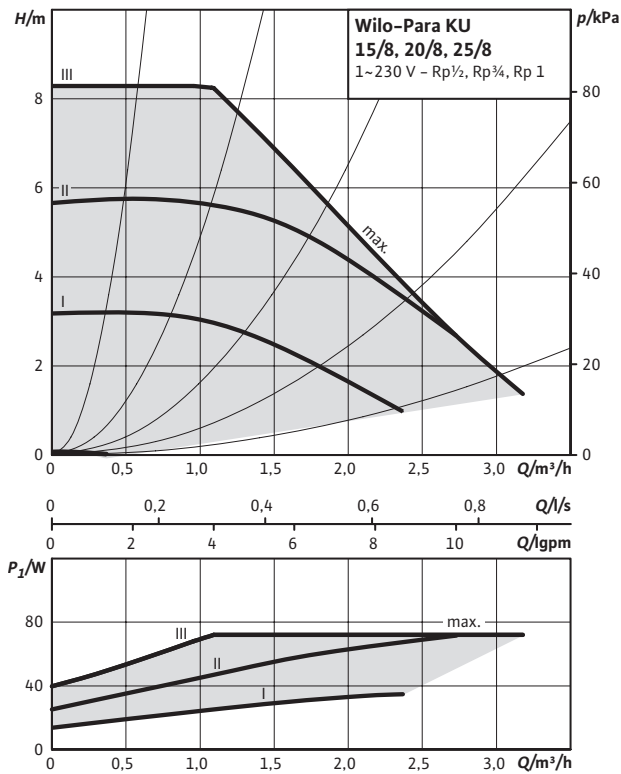

Pump curves

External control via PWM/LIN

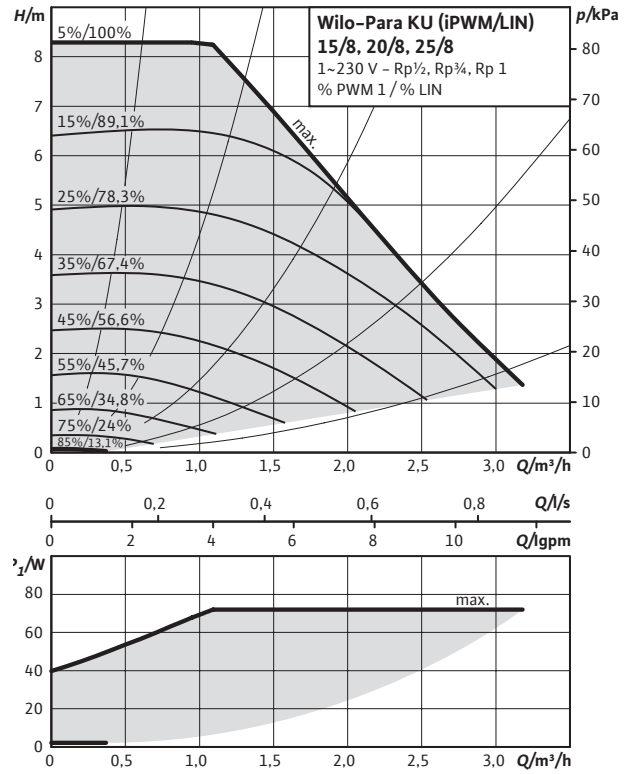

Dimension drawing SC

Wilo-Para KU

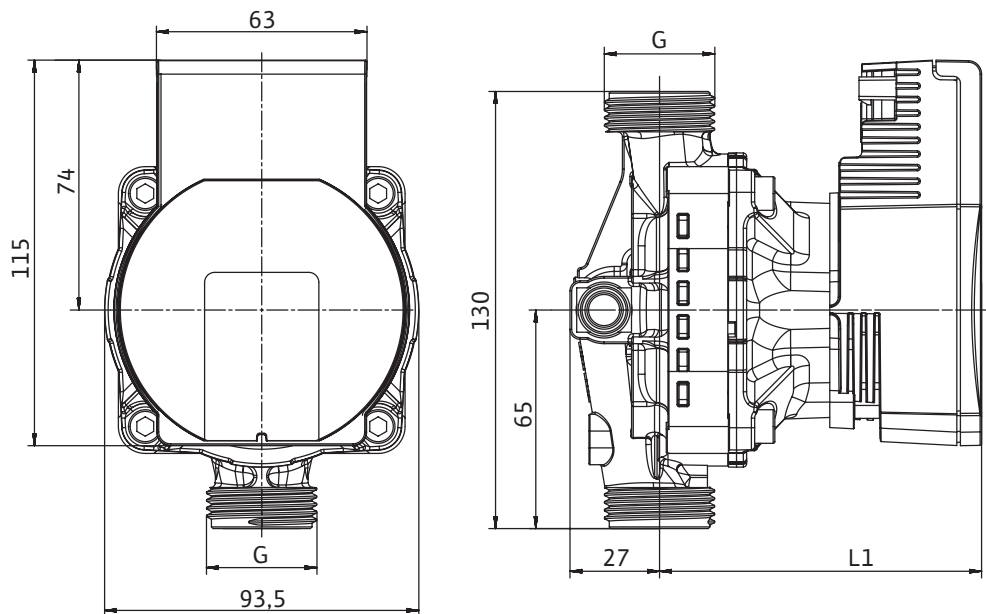

Technical data

Designation	Para KU15-130/6-43/SC	Para KU15-130/7-50/SC	Para KU15-130/8-75/SC
Threaded pipe union		Rp 1/2	
Thread		G 1	
Overall length l_o		130 mm	
Weight approx. m	0.9 kg		1.1 kg
Dimensions $L1$	96 mm		108 mm

Technical data

Designation	Para KU20-130/6-43/SC	Para KU20-130/7-50/SC	Para KU20-130/8-75/SC
Threaded pipe union		Rp 3/4	
Thread		G 1 1/4	
Overall length l_o		130 mm	
Weight approx. m	0.9 kg		1.1 kg
Dimensions $L1$	96 mm		108 mm

Technical data

Designation	Para KU25-130/6-43/SC	Para KU25-130/7-50/SC	Para KU25-130/8-75/SC
Threaded pipe union		Rp 1	
Thread		G 1 1/2	
Overall length l_o		130 mm	
Weight approx. m	0.9 kg		1.1 kg
Dimensions $L1$	96 mm		108 mm

Materials

Pump housing	PA6.6 with GF 30%
Impeller	PP composite with GF 40%
Pump shaft	Stainless steel
Bearing	Carbon, metal impregnated

Dimension drawing iPWM1

Wilo-Para KU

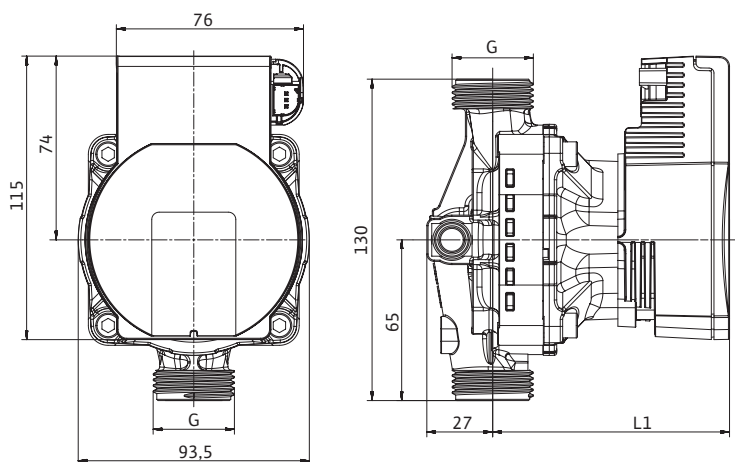

Technical data			
Designation	Para KU15-130/6-43*	Para KU15-130/7-50*	Para KU15-130/8-75*
Threaded pipe union		Rp 1/2	
Thread		G 1	
Overall length l_o		130 mm	
Weight approx. m		0.9 kg	1.1 kg
Dimensions $L1$		96 mm	108 mm

Technical data			
Designation	Para KU20-130/6-43*	Para KU20-130/7-50*	Para KU20-130/8-75*
Threaded pipe union	Rp 3/4	Rp 3/4	Rp 3/4
Thread		G 1 1/4	
Overall length l_o		130 mm	
Weight approx. m		0.9 kg	1.1 kg
Dimensions $L1$		96 mm	108 mm

Technical data			
Designation	Para KU25-130/6-43*	Para KU25-130/7-50*	Para KU25-130/8-75*
Threaded pipe union		Rp 1	
Thread		G 1 1/2	
Overall length l_o		130 mm	
Weight approx. m		0.9 kg	1.1 kg
Dimensions $L1$		96 mm	108 mm

Materials	
Pump housing	PA6.6 with GF 30%
Impeller	PP composite with GF 40%
Pump shaft	Stainless steel
Bearing	Carbon, metal impregnated

*IPWM1 or LIN

Wilo-Para KU - Screwing instructions

Maximal torque on connections G 1", 1 1/4", 1 1/2" : 40 Nm

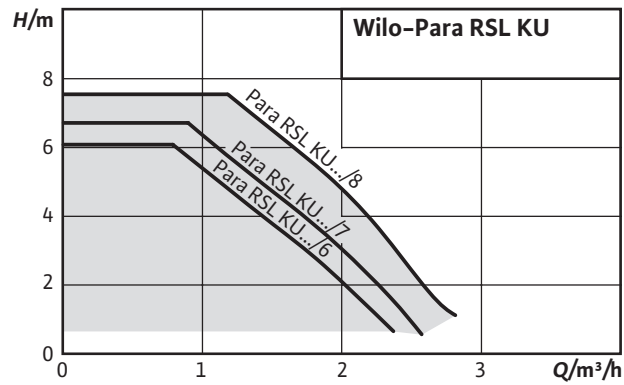

Wilo-Para RSL KU



Motor data SC

Para	Speed	EEl	Power consumption 1~230 V	Current at 1~230V	Motor protection
	<i>n</i> rpm		<i>P</i> ₁ W	<i>I</i> A	
RSL KU/6-43/SC	2430 - 4300	≤ 0.20	3-43	0.04 - 0.44	integrated
RSL KU/7-50/SC	2580 - 4700	≤ 0.20	6-50	0.07 - 0.44	integrated
RSL KU/8-75/SC	3000 - 4800	≤ 0.21	10-75	0.03 - 0.66	integrated

Motor data iPWM

Para	Speed	EEl	Power consumption 1~230 V	Current at 1~230V	Motor protection
	<i>n</i> rpm		<i>P</i> ₁ W	<i>I</i> A	
RSL KU/6-43*	700 - 4300	≤ 0.20	1-43	0.04 - 0.44	integrated
RSL KU/7-50*	700 - 4700	≤ 0.20	1-50	0.02 - 0.44	integrated
RSL KU/8-75*	500 - 4800	≤ 0.21	2-75	0.03 - 0.66	integrated

*iPWM1 or LIN

Pump curves
 $\Delta p-v$ (variable)

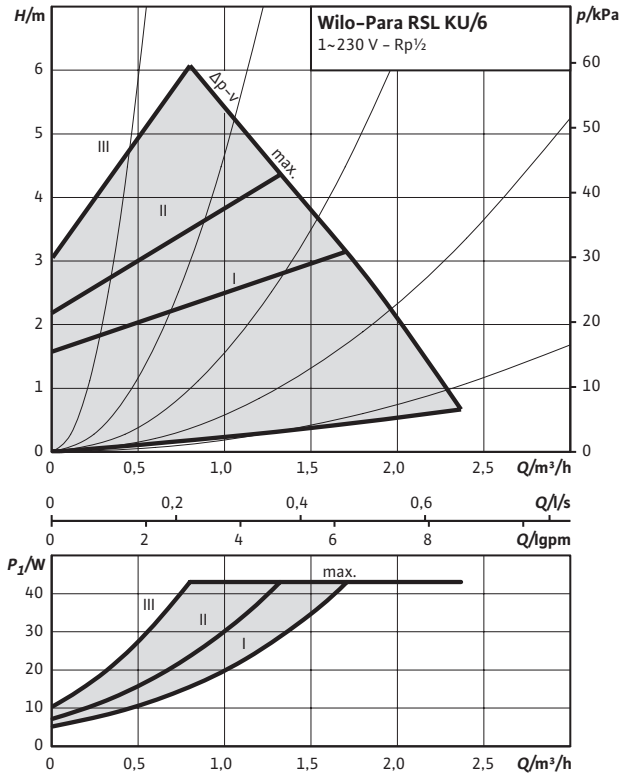

Pump curves
 $\Delta p-c$ (constant)

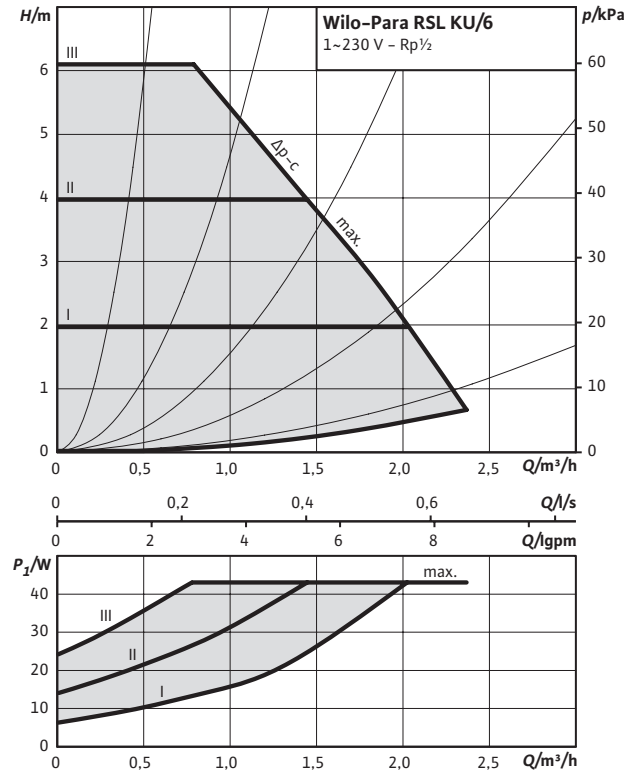

Pump curves
Constant speed I, II, III

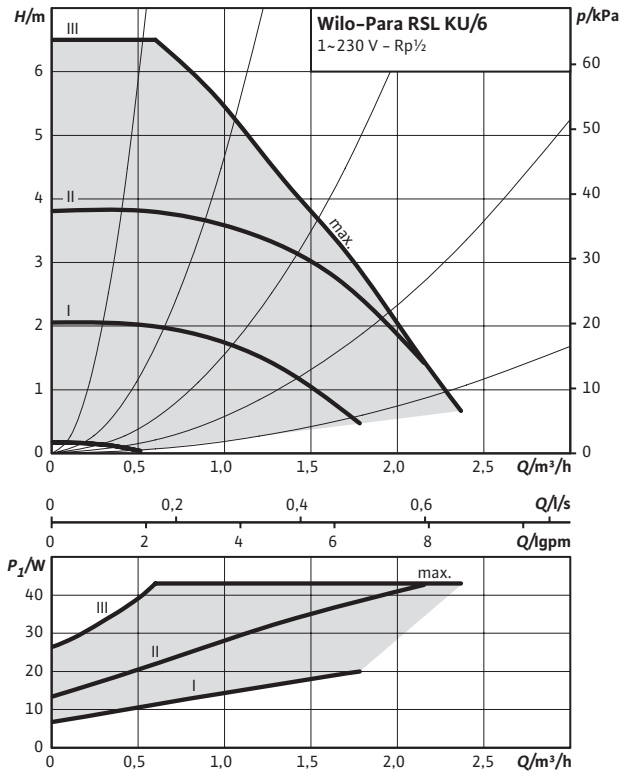

Pump curves
External control via PWM/LIN

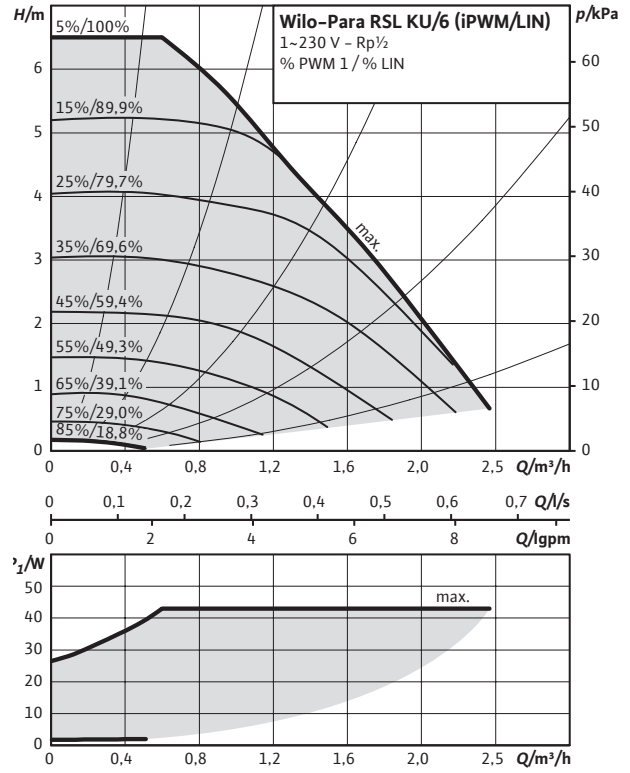

Pump curves

$\Delta p-v$ (variable)

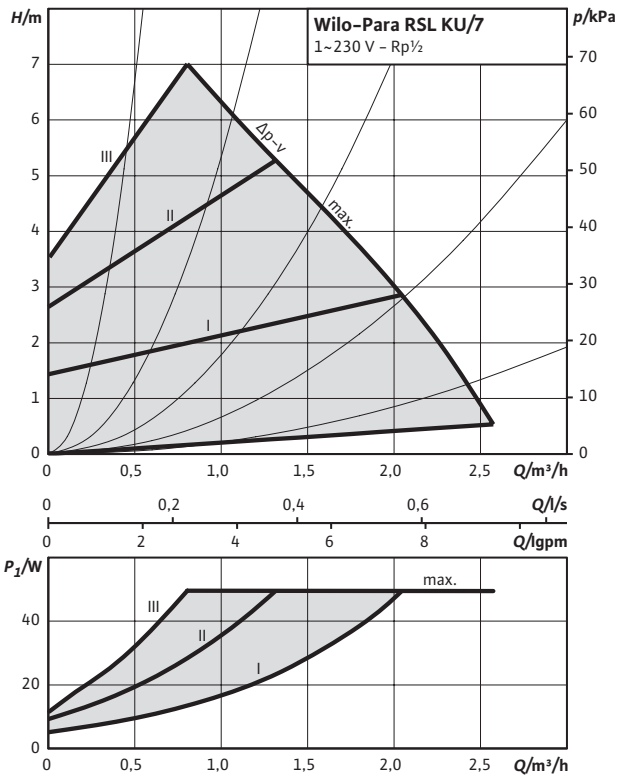

Pump curves

$\Delta p-c$ (constant)

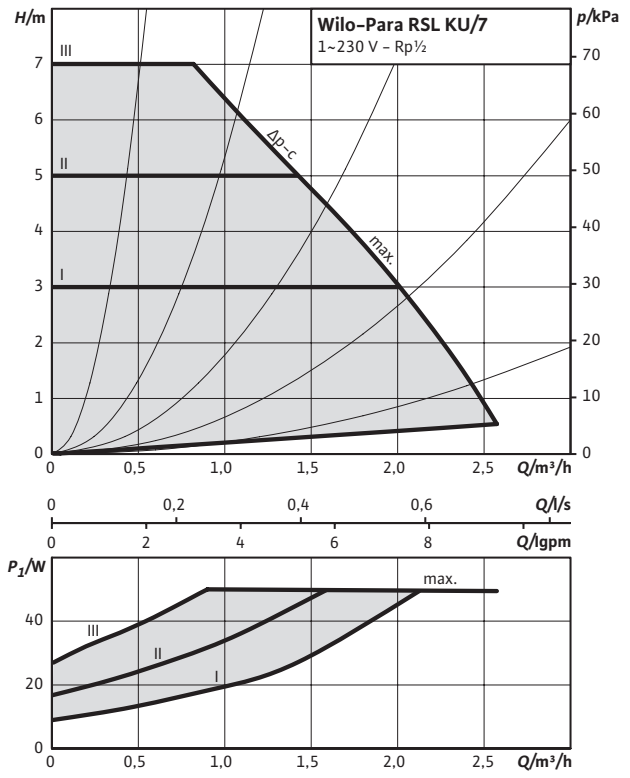

Pump curves

Constant speed I, II, III

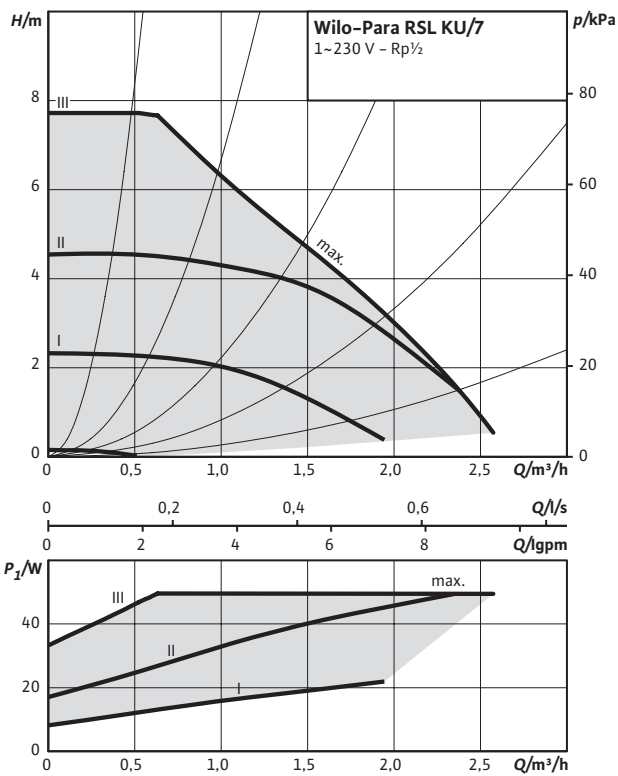

Pump curves

External control via PWM1/LIN

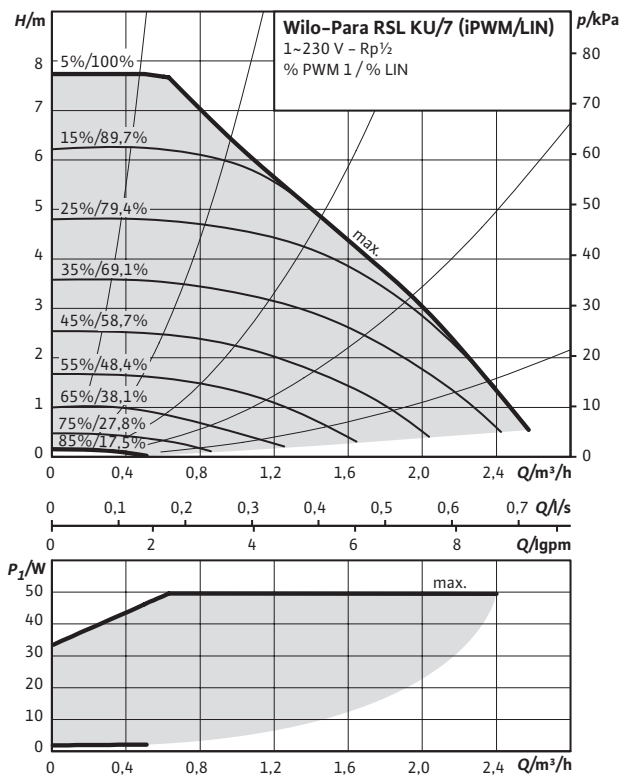

Pump curves

$\Delta p-v$ (variable)

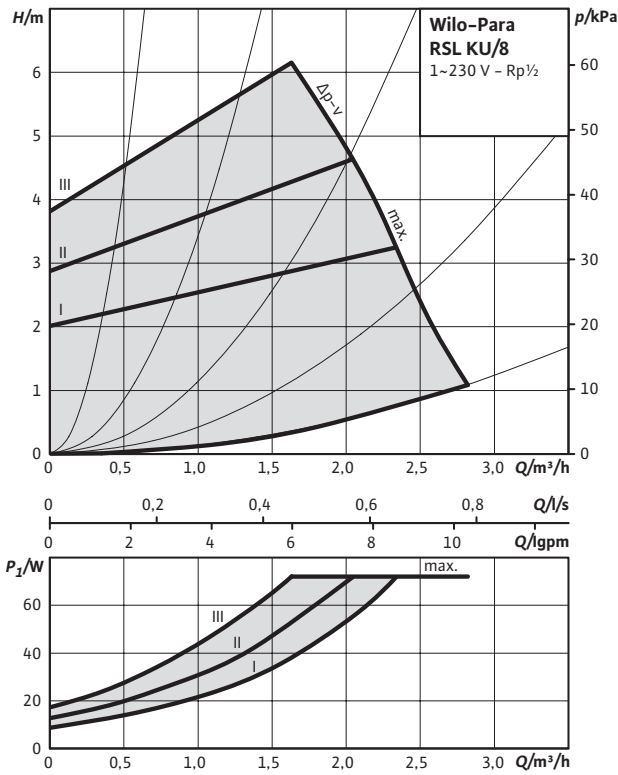

Pump curves

$\Delta p-c$ (constant)

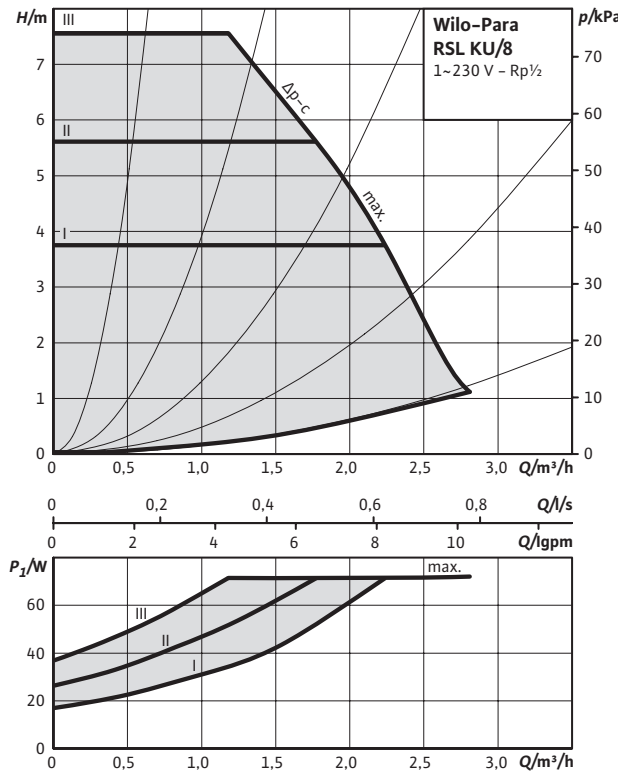

Pump curves

Constant speed I, II, III

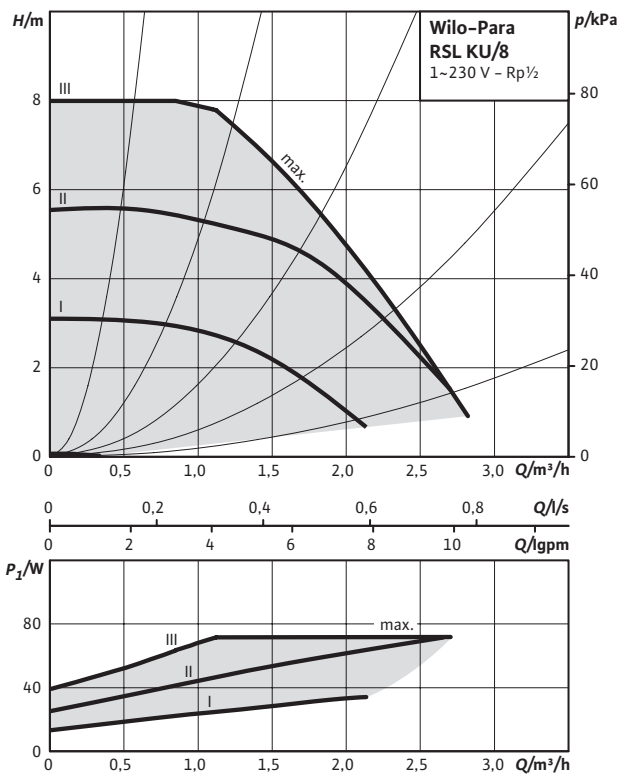

Pump curves

External control via PWM1/LIN

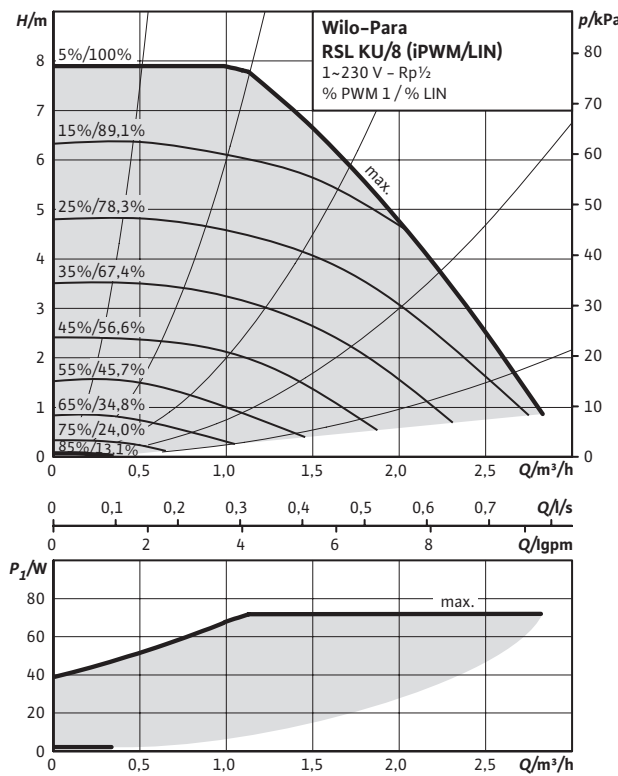

Dimension drawing SC

Wilo-Para RSL

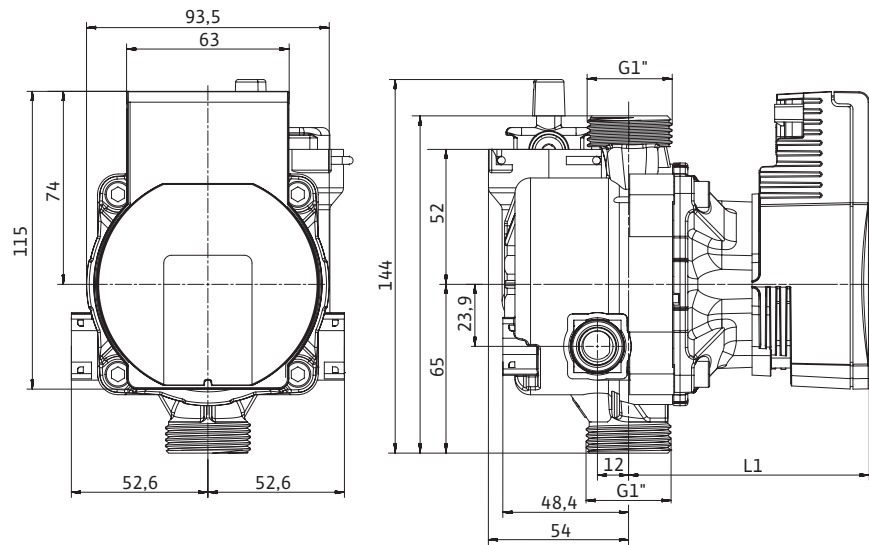

Technical data

Designation	Para RSL KU/6-43/SC	Para RSL KU/7-50/SC	Para RSL KU/8-75/SC
Threaded pipe union		Rp 1/2	
Thread		G 1	
Overall length l_o		130 mm	
Weight approx. m		1 kg	1.2 kg
Dimensions $L1$		93 mm	105 mm

Materials

Pump housing	PA6.6 with GF 30%
Impeller	PP composite with GF 40%
Pump shaft	Stainless steel
Bearing	Carbon, metal impregnated

Dimension drawing iPWM1/LIN
Wilo-Para RSL

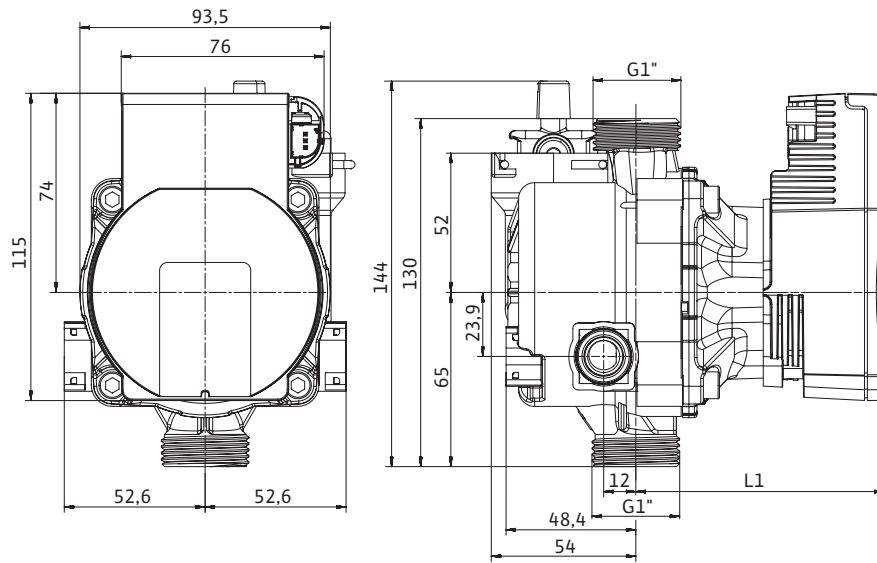

Technical data

Designation	Para RSL KU/6-43*	Para RSL KU/7-50*	Para RSL KU/8-75*
Threaded pipe union		Rp 1/2	
Thread		G 1	
Overall length l_0		130 mm	
Weight approx. m		1 kg	1.2 kg
Dimensions $L1$		93 mm	105 mm

Materials

Pump housing	PA6.6 with GF 30%		
Impeller	PP composite with GF 40%		
Pump shaft	Stainless steel		
Bearing	Carbon, metal impregnated		

*IPWM1 or LIN

Optional connections

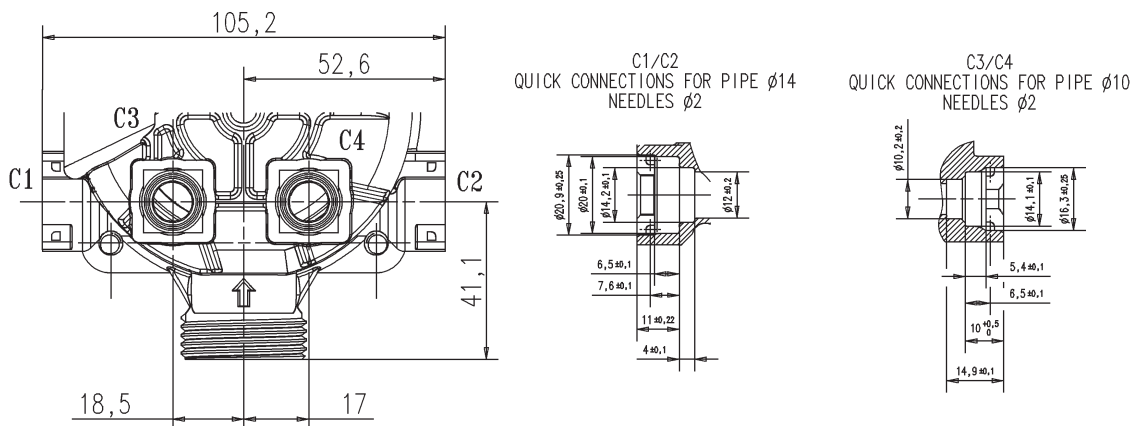

Wilo-Para RSL - Screwing instructions

Maximal torque on connections G 1", 1 1/4", 1 1/2" : 40 Nm

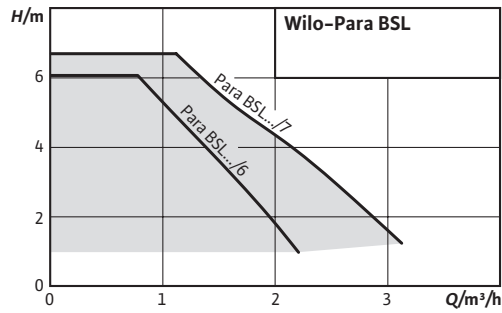

Wilo-Para BSL



Motor data SC

Para	Speed	EEl	Power consumption 1-230 V	Current at 1-230V	Motor protection
	<i>n</i> rpm		P_1 W	<i>I</i> A	
BSL/6-43/SC	2430 - 4300	≤ 0.20	3-43	0.04 - 0.44	integrated
BSL/7-50/SC	2580-4700	≤ 0.20	6-50	0.07 - 0.44	integrated

Motor data iPWM

Para	Speed	EEl	Power consumption 1-230 V	Current at 1-230V	Motor protection
	<i>n</i> rpm		P_1 W	<i>I</i> A	
BSL/6-43*	700 - 4300	≤ 0.20	1-43	0.04 - 0.44	integrated
BSL/7-50*	700 - 4700	≤ 0.20	1-50	0.02 - 0.44	integrated

*iPWM or LIN

Pump curves

$\Delta p-v$ (variable)

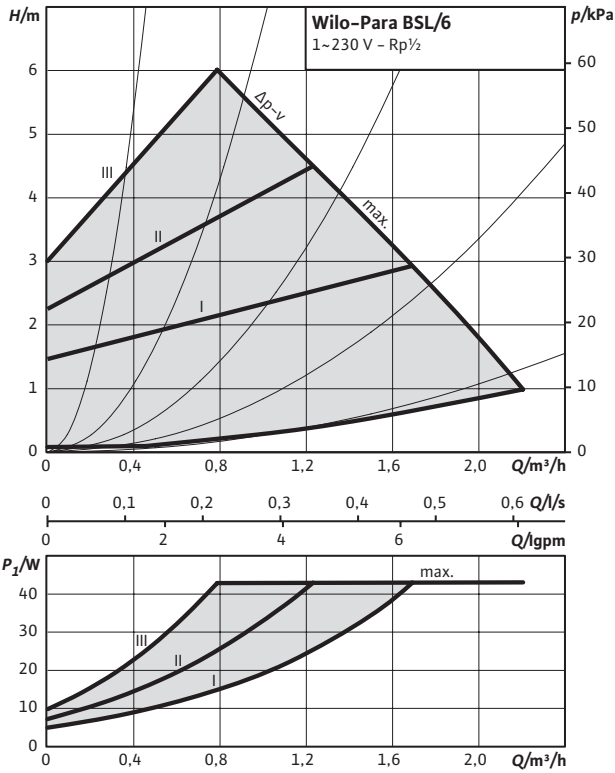

Pump curves

$\Delta p-c$ (constant)

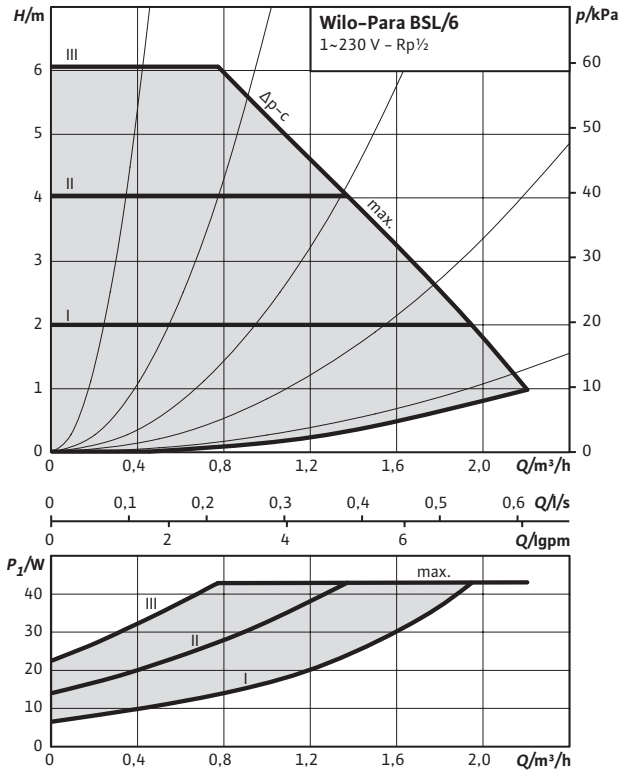

Pump curves

Constant speed I, II, III

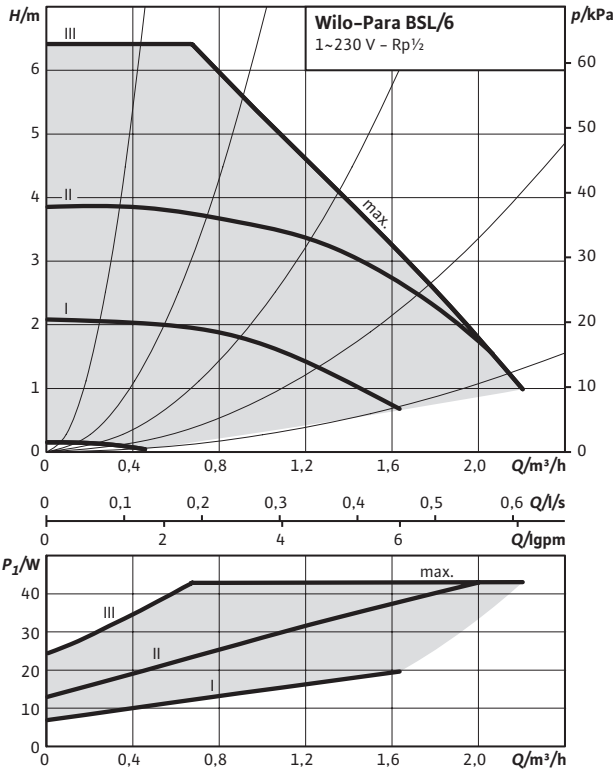

Pump curves

External control via PWM/LIN

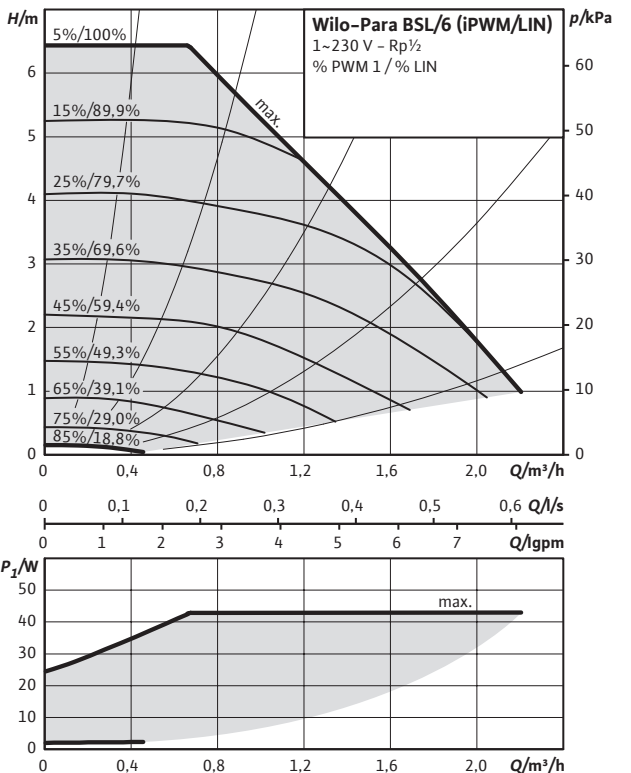

Pump curves

$\Delta p-v$ (variable)

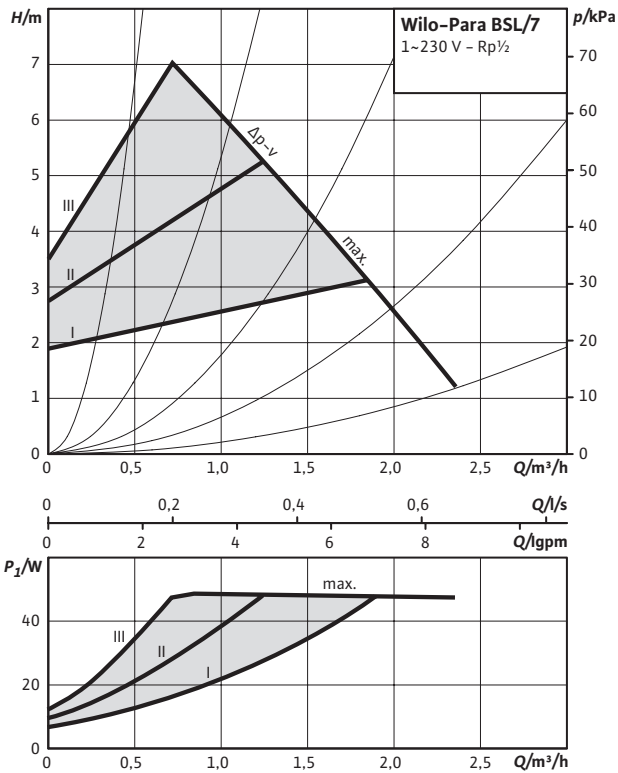

Pump curves

$\Delta p-c$ (constant)

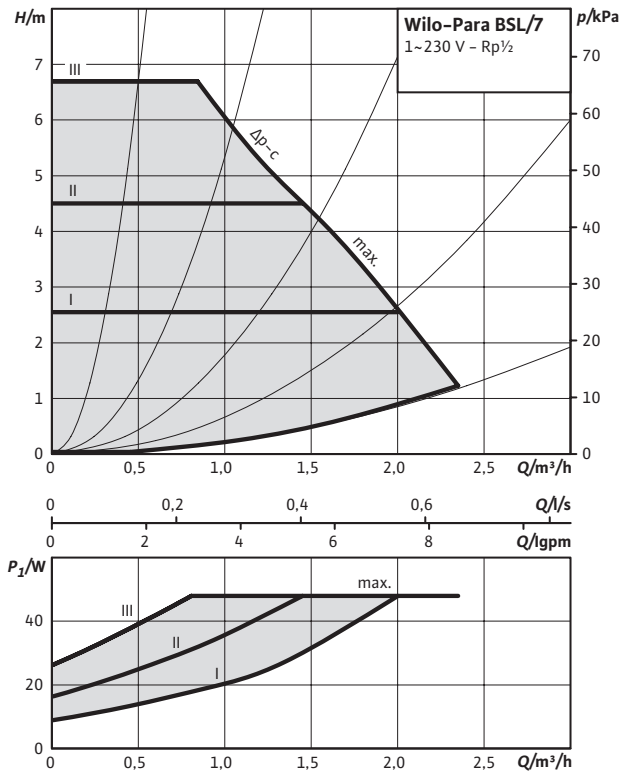

Pump curves

Constant speed I, II, III

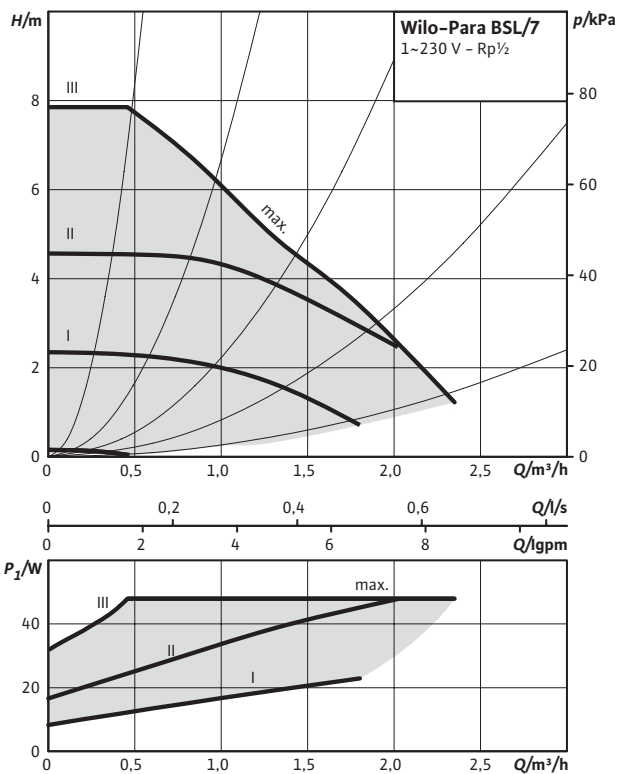

Pump curves

External control via PWM1/LIN

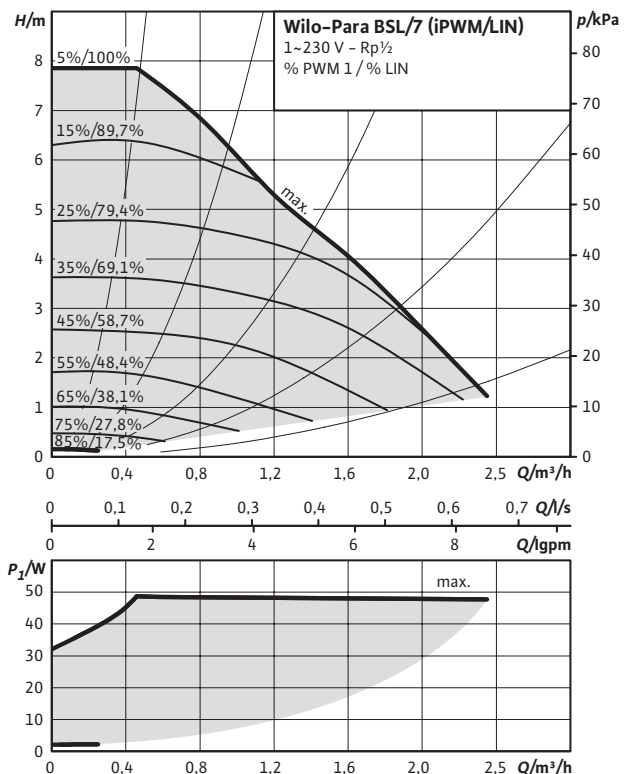

Dimension drawing SC

Wilo-Para BSL

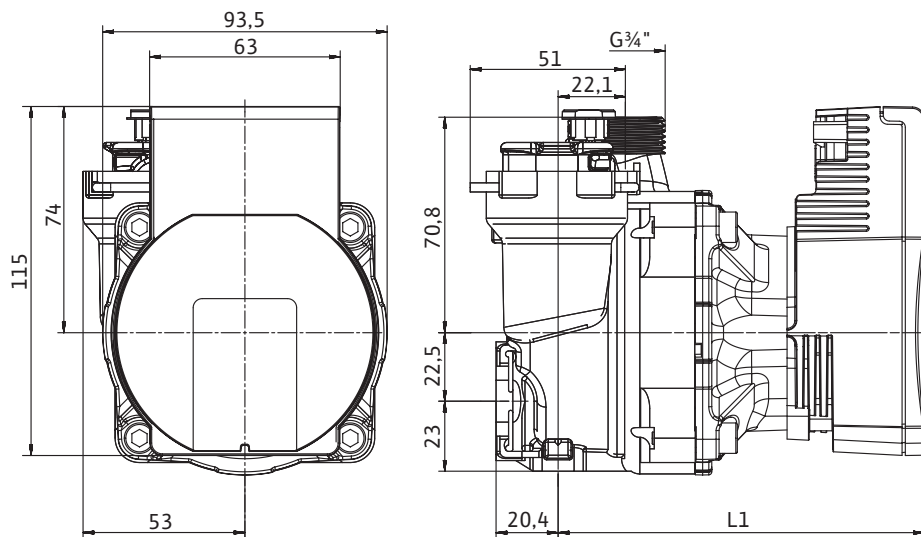

Technical data

Designation	Para BSL/6-43/SC	Para BSL/7-50/SC
Threaded pipe union		Rp 1/2
Thread		G 3/4
Weight approx. <i>m</i>		1 kg
Dimensions <i>L1</i>		120 mm
Materials		
Pump housing		PA6.6 with GF 30 %
Impeller		PP composite with GF 40%
Pump shaft		Stainless steel
Bearing		Carbon, metal impregnated

Dimension drawing iPWM1/LIN

Wilo-Para BSL

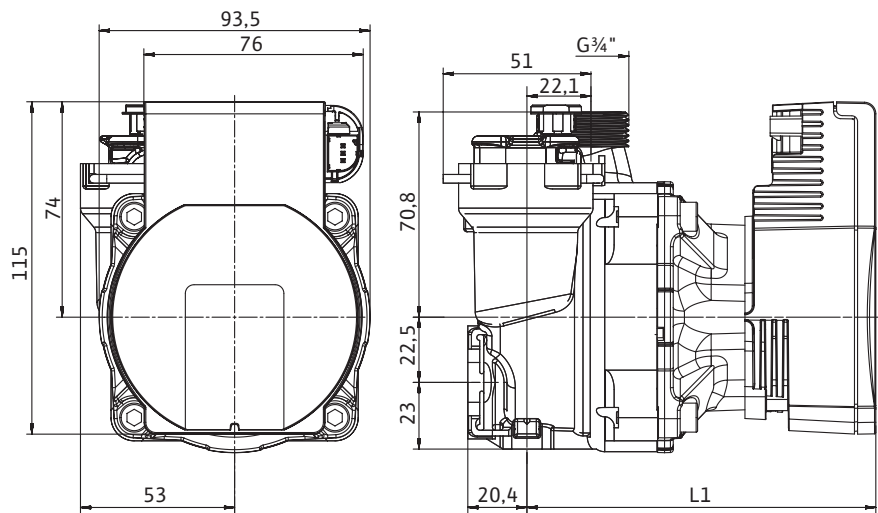

Technical data

Designation	Para BSL/6-43*	Para BSL/7-50*
Threaded pipe union		Rp 1/2
Thread		G 3/4
Weight approx. <i>m</i>		1 kg
Dimensions <i>L1</i>		120 mm
Materials		
Pump housing		PA6.6 with GF 30%
Impeller		PP composite with GF 40%
Pump shaft		Stainless steel
Bearing		Carbon, metal impregnated

*iPWM1 or LIN

Wilo-Para BSL - Screwing instructions

Maximal torque on connections G 1", 1 1/4", 1 1/2" : 40 Nm

Optional connections

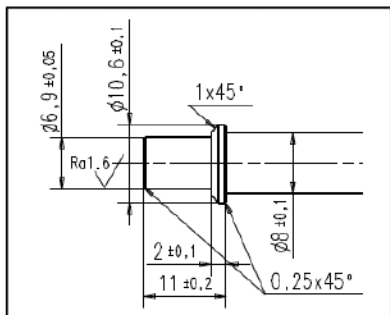

O-ring
 $\varnothing 6 \times \varnothing 2.2$
 EPDM 70Sh

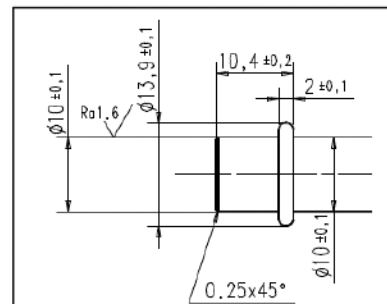

O-ring
 $\varnothing 9.19 \times \varnothing 2.62$
 EPDM 70Sh



Wilo Intec 4523102

For threaded
 Nut G3/4" Maximal torque 25Nm
 Screwed on minimal 4 threads

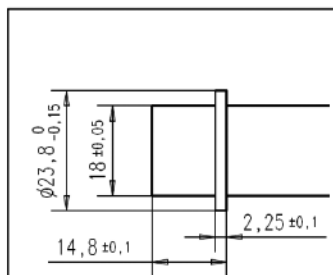

O-ring
 $\varnothing 17 \times \varnothing 4$
 EPDM 70Sh



Wilo Intec 4522417

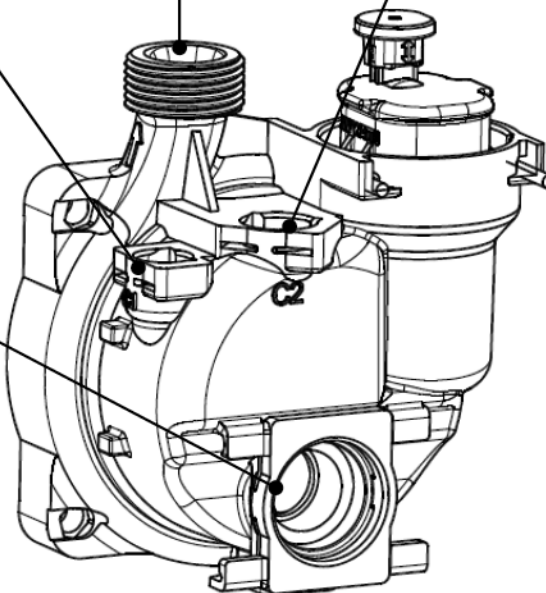

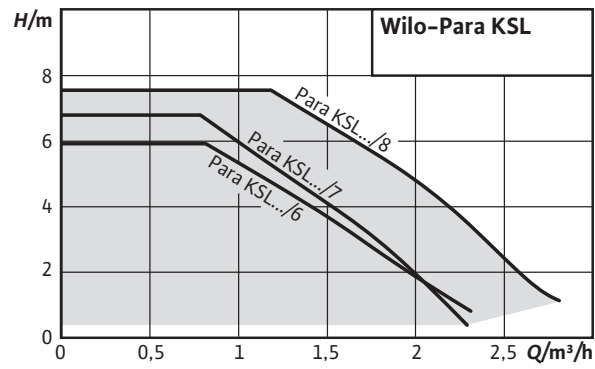

Wilo-PARA KSL



Motor data SC

Para	Speed	EEI	Power consumption 1~230 V	Current at 1~230V	Motor protection
	<i>n</i> rpm		P_1 W	<i>I</i> A	
KSL/6-43/SC	2430 - 4300	≤ 0.20	3-43	0.04 - 0.44	integrated
KSL/7-50/SC	2580 - 4700	≤ 0.20	6-50	0.07 - 0.44	integrated
KSL/8-75/SC	3000 - 4800	≤ 0.21	10-75	0.03 - 0.66	integrated

Motor data iPWM1/LIN

Para	Speed	EEI	Power consumption 1~230 V	Current at 1~230V	Motor protection
	<i>n</i> rpm		P_1 W	<i>I</i> A	
KSL/6-43*	700 - 4300	≤ 0.20	1-43	0.04 - 0.44	integrated
KSL/7-50*	700 - 4700	≤ 0.20	1-50	0.02 - 0.44	integrated
KSL/8-75*	500 - 4800	≤ 0.21	2-75	0.03 - 0.66	integrated

*iPWM1 or LIN

Pump curves

$\Delta p-v$ (variable)

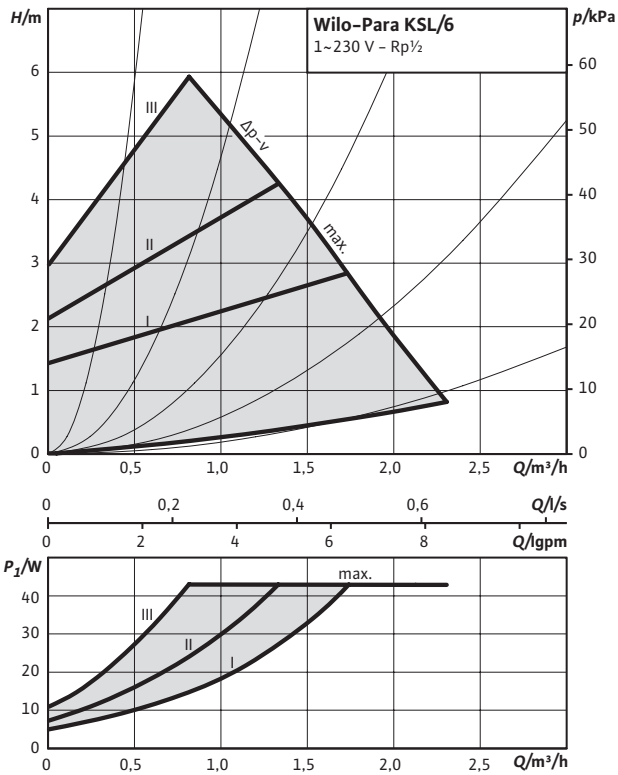

Pump curves

$\Delta p-c$ (constant)

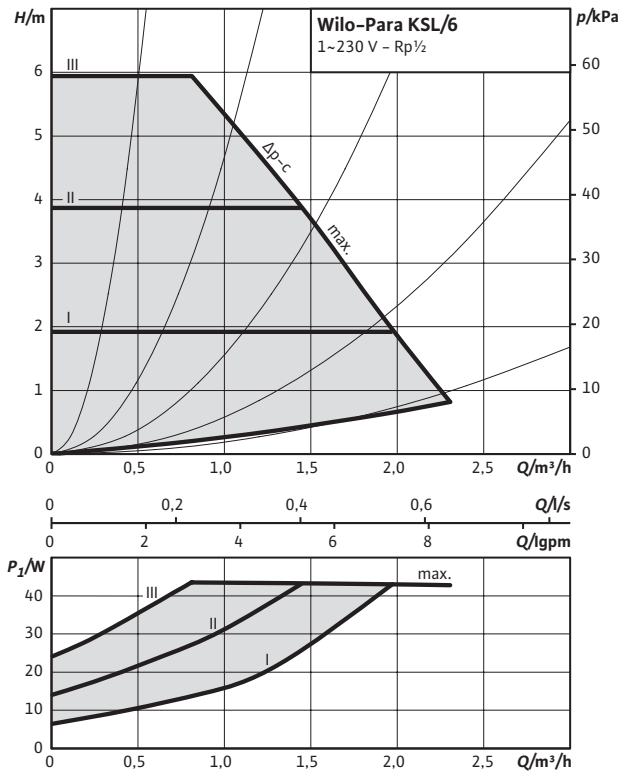

Pump curves

Constant speed I, II, III

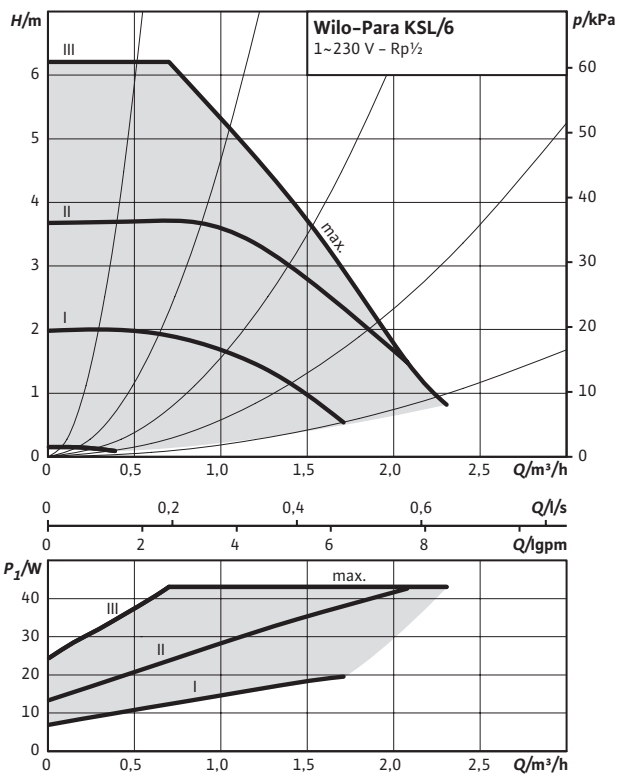

Pump curves

External control via PWM/LIN

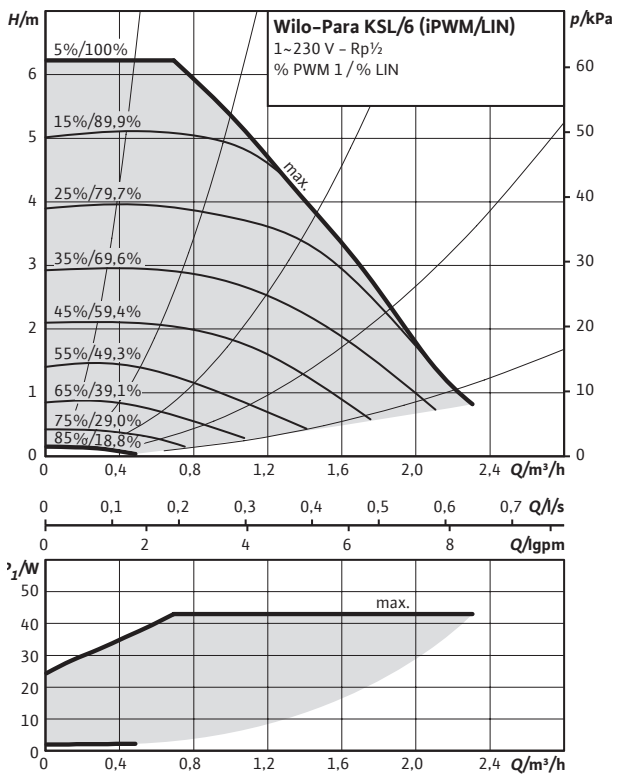

Pump curves

$\Delta p-v$ (variable)

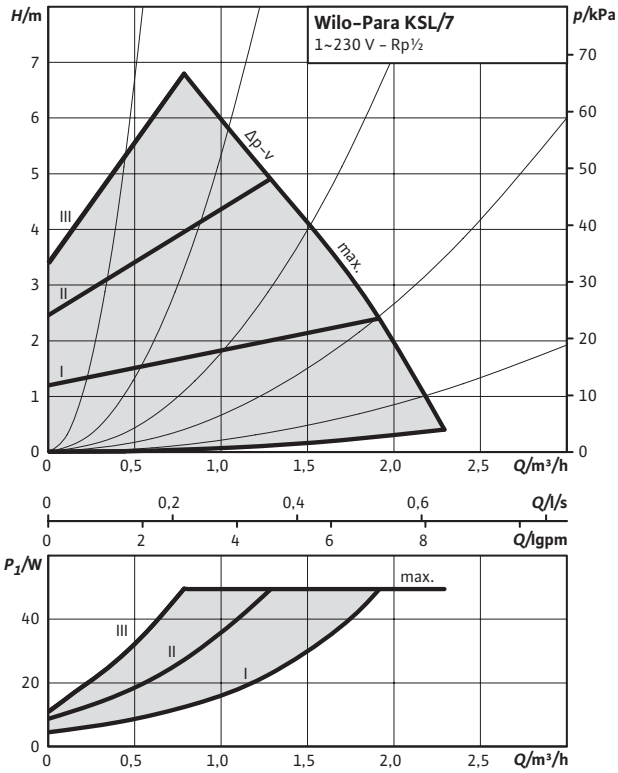

Pump curves

$\Delta p-c$ (constant)

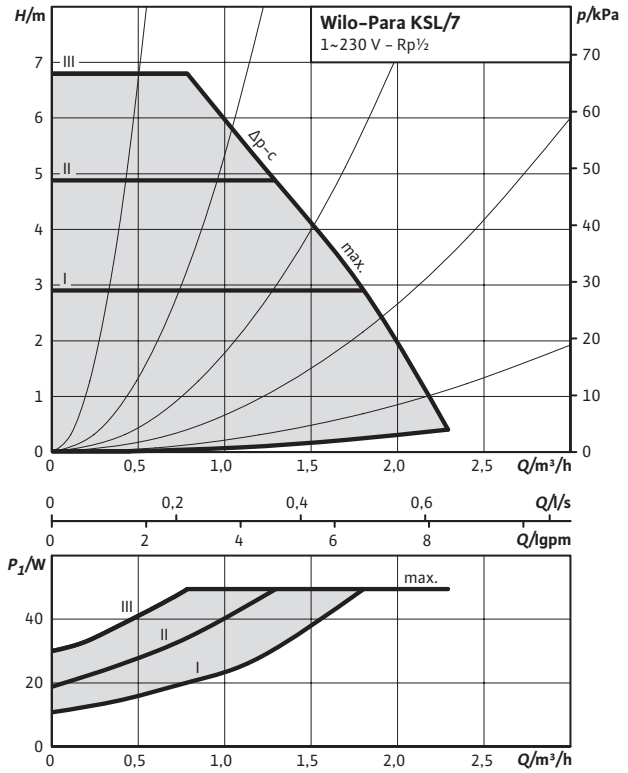

Pump curves

Constant speed I, II, III

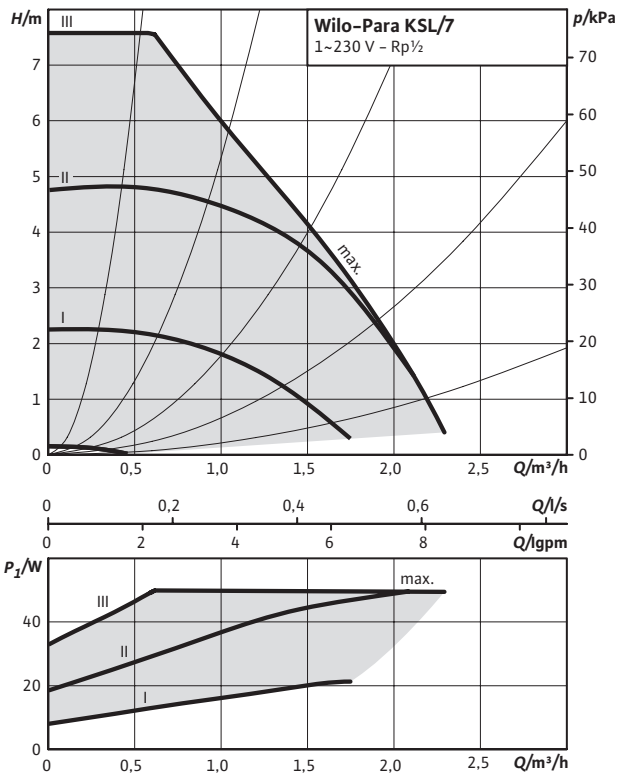

Pump curves

External control via PWM1/LIN

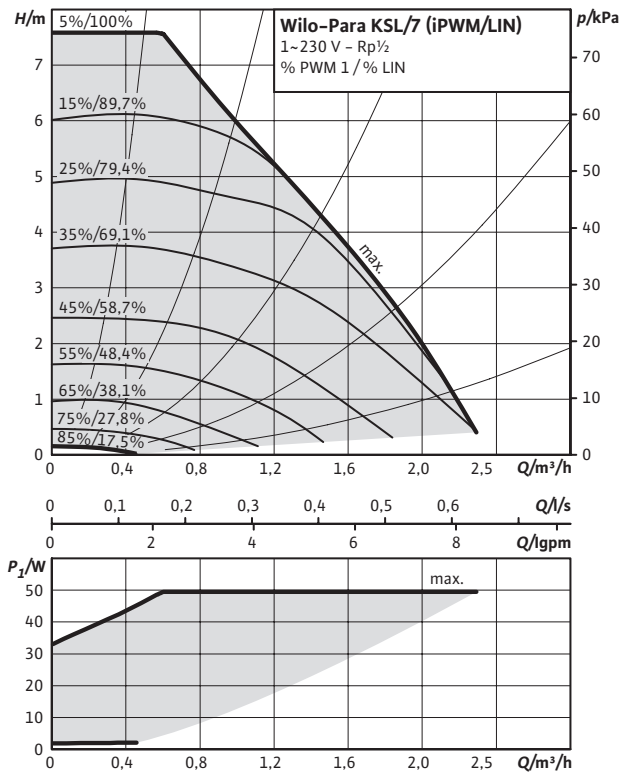

Pump curves

$\Delta p-v$ (variable)

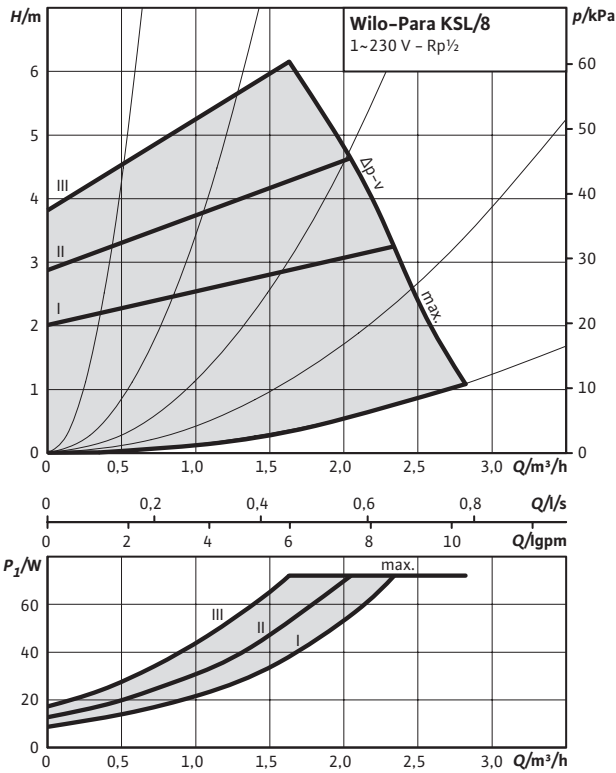

Pump curves

$\Delta p-c$ (constant)

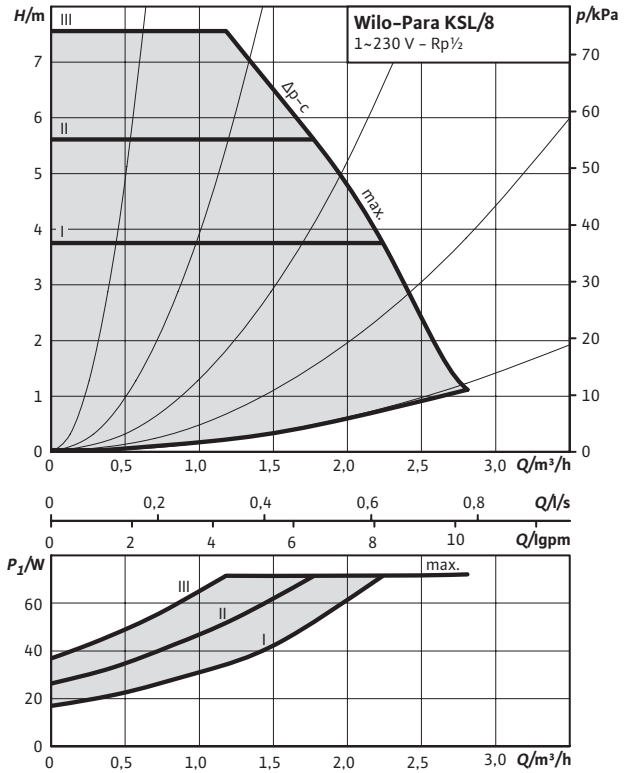

Pump curves

Constant speed I, II, III

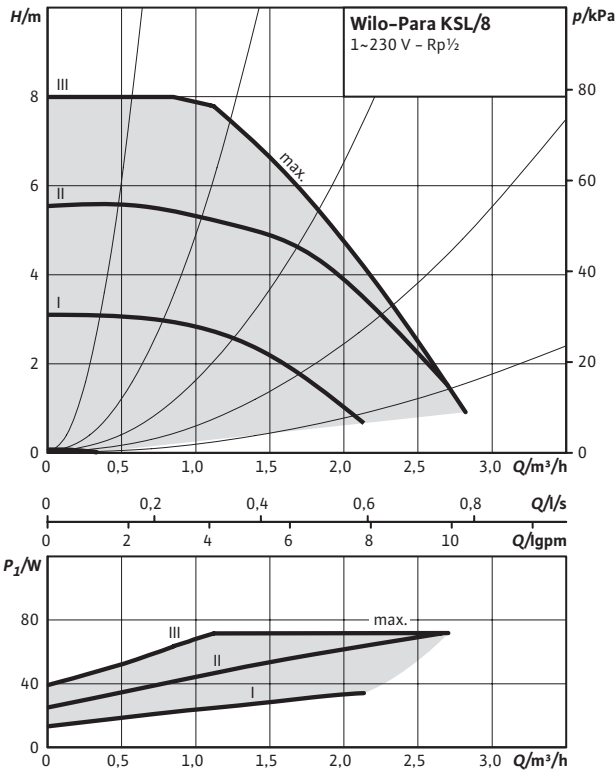

Pump curves

External control via PWM/LIN

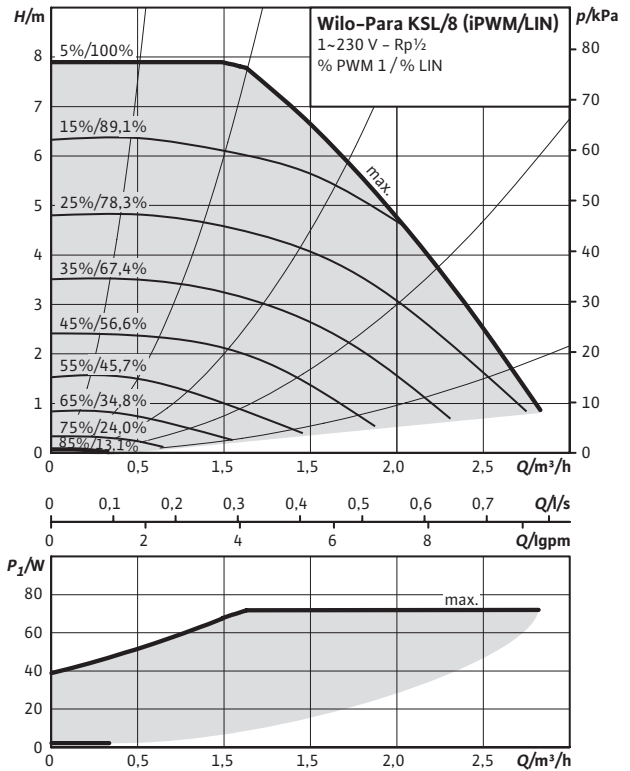

Dimension drawing SC

Wilo-Para KSL

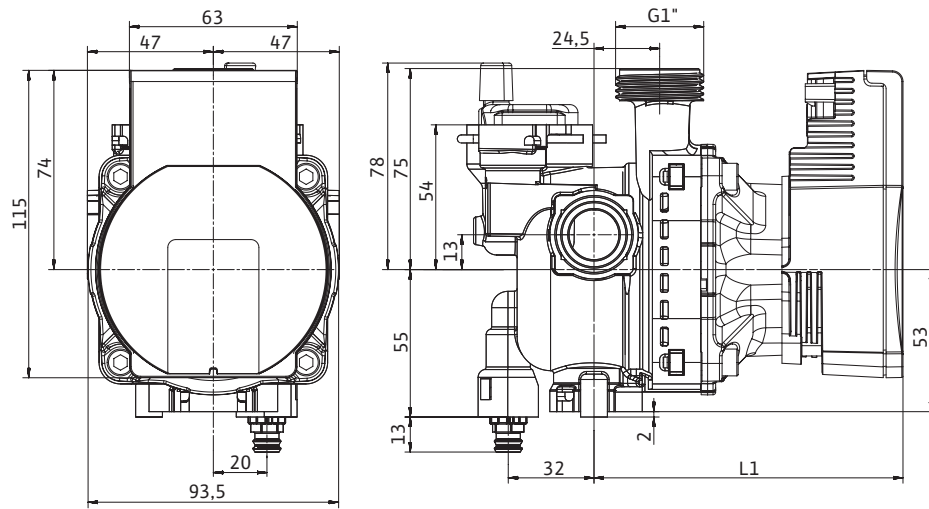

Technical data			
Designation	Para KSL/6-43/SC	Para KSL/7-50/SC	Para KSL/8-75/SC
Threaded pipe union			Rp 1/2
Thread			G 1
Weight approx. <i>m</i>		1 kg	1.2 kg
Dimensions <i>L1</i>		115 mm	127 mm
Materials			
Pump housing		PA6.6 with GF 30%	
Impeller		PP composite with GF 40%	
Pump shaft		Stainless steel	
Bearing		Carbon, metal impregnated	

Dimension drawing iPWM1/LIN

Wilo-Para KSL

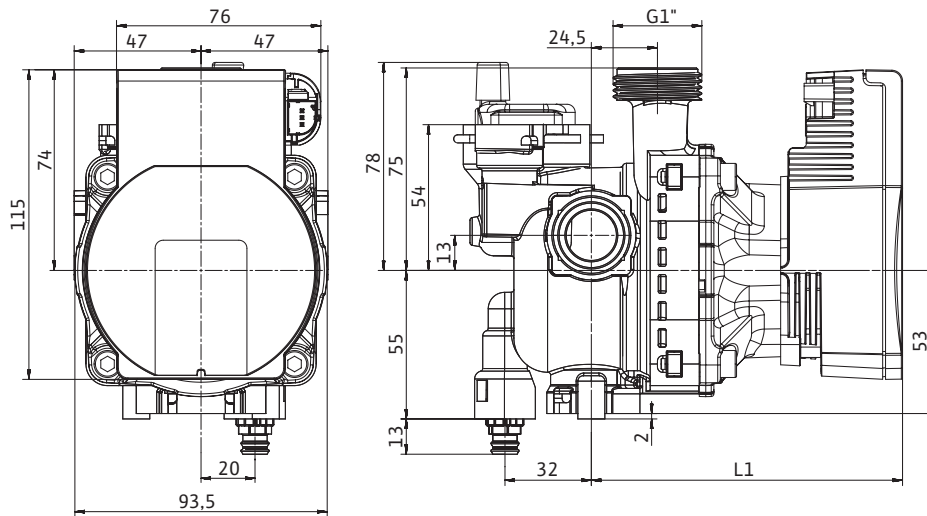

Technical data			
Designation	Para KSL/6-43*	Para KSL/7-50*	Para KSL/8-75*
Threaded pipe union		Rp ½	
Thread		G 1	
Weight approx. <i>m</i>		1 kg	1.2 kg
Dimensions <i>L1</i>		115 mm	127 mm
Materials			
Pump housing	PA6.6 with GF 30%		
Impeller	PP composite with GF 40%		
Pump shaft	Stainless steel		
Bearing	Carbon, metal impregnated		

*IPWM1 or LIN

Wilo-Para KSL - Screwing instructions

Maximal torque on connections G 1", 1"¼, 1"½ : 40 Nm

Optional connections

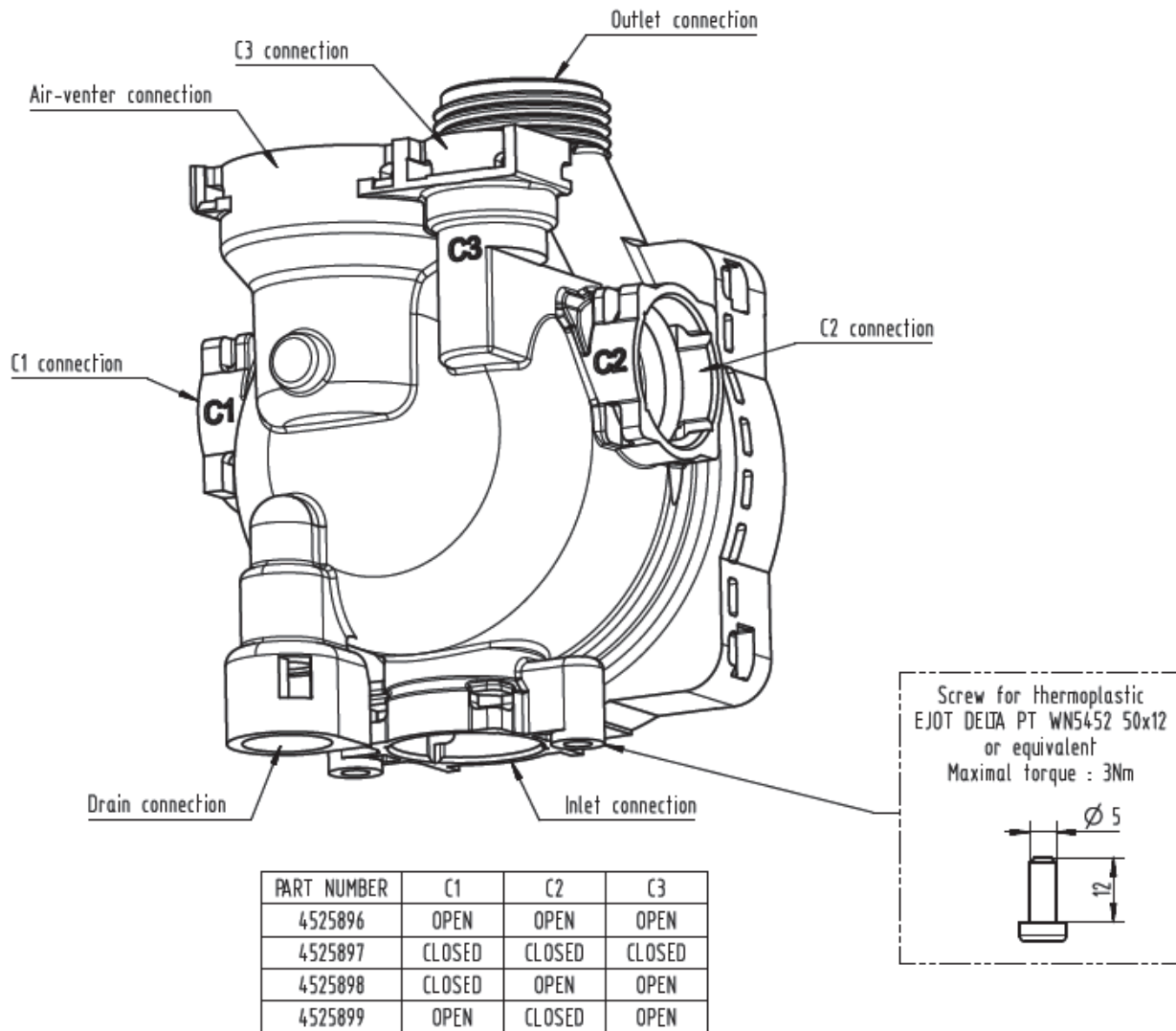

PART NUMBER	C1	C2	C3
4525896	OPEN	OPEN	OPEN
4525897	CLOSED	CLOSED	CLOSED
4525898	CLOSED	OPEN	OPEN
4525899	OPEN	CLOSED	OPEN

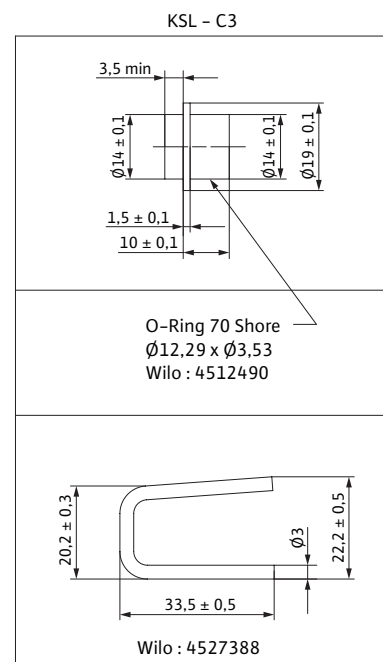
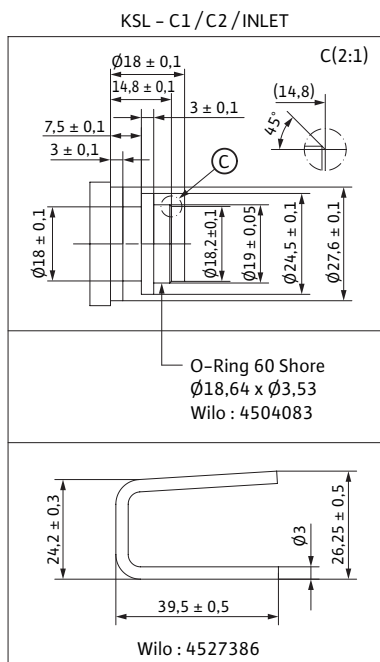

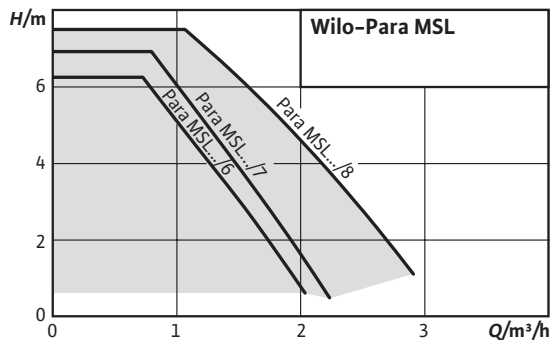

Wilo-Para MSL



Motor data SC

Para	Speed	EEl	Power consumption 1~230 V	Current at 1~230V	Motor protection
	<i>n</i> rpm		P_1 W	<i>I</i> A	
MSL/6-43/SC	2430 - 4300	≤ 0.20	3-43	0.04 - 0.44	integrated
MSL/7-50/SC	2580 - 4700	≤ 0.20	6-50	0.07 - 0.44	integrated
MSL/8-75/SC	3000 - 4800	≤ 0.21	10-75	0.03 - 0.66	integrated

Motor data iPWM1/LIN

Para	Speed	EEl	Power consumption 1~230 V	Current at 1~230V	Motor protection
	<i>n</i> rpm		P_1 W	<i>I</i> A	
MSL/6-43*	700 - 4300	≤ 0.20	1-43	0.04 - 0.44	integrated
MSL/7-50*	700 - 4700	≤ 0.20	1-50	0.02 - 0.44	integrated
MSL/8-75*	500 - 4800	≤ 0.21	2-75	0.03 - 0.66	integrated

*iPWM1 or LIN

Pump curves

$\Delta p-v$ (variable)

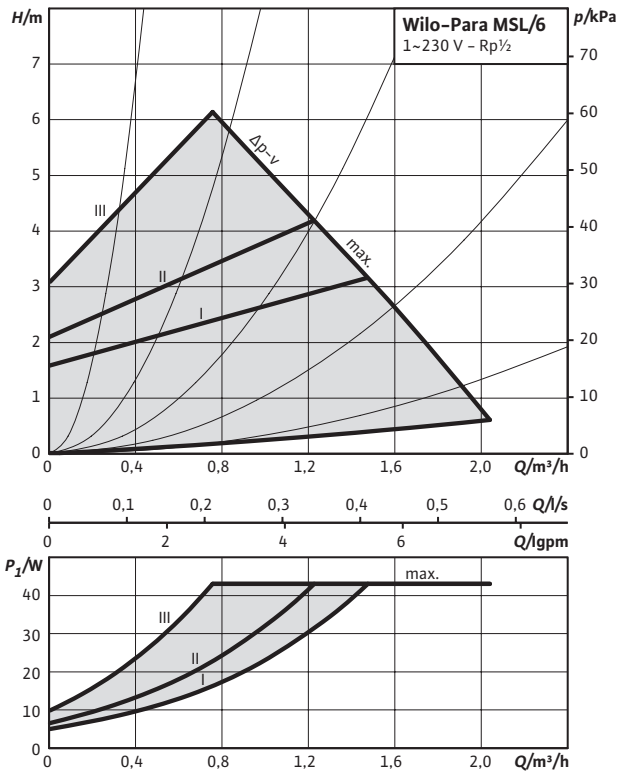

Pump curves

$\Delta p-c$ (constant)

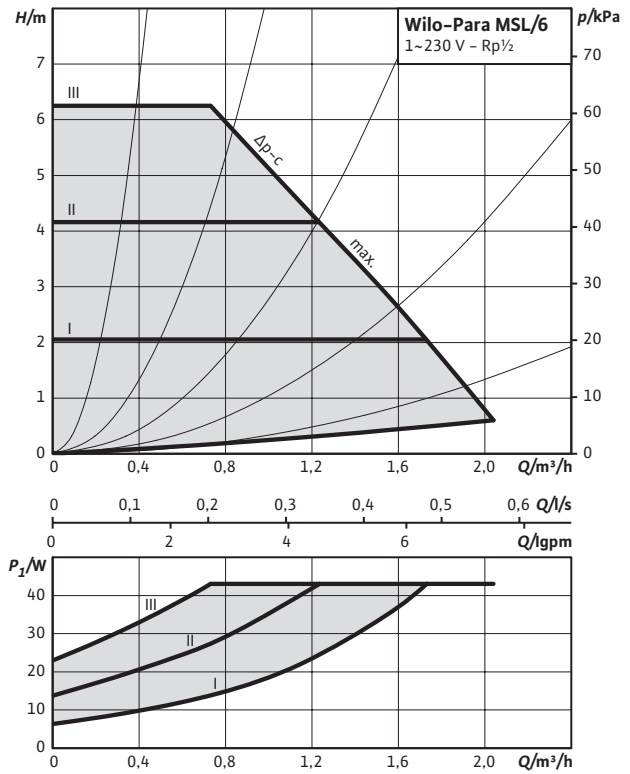

Pump curves

Constant speed I, II, III

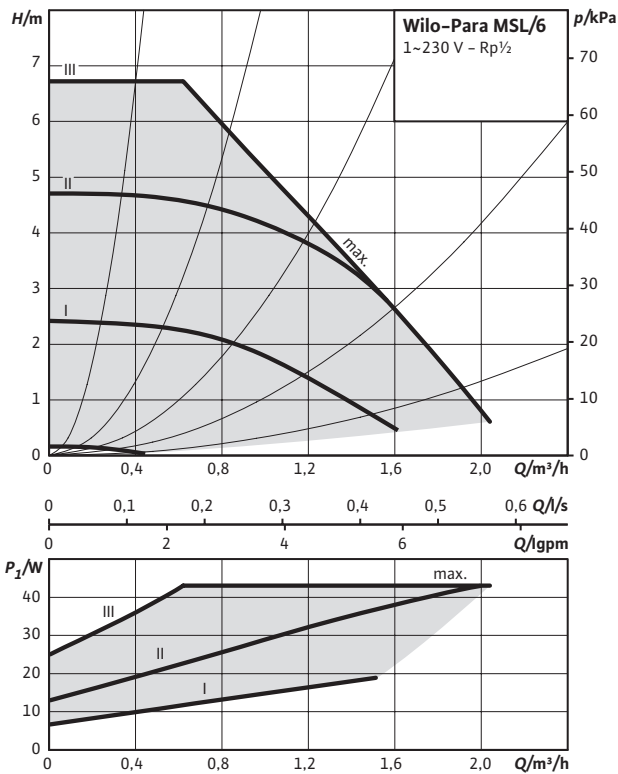

Pump curves

External control via PWM1/LIN

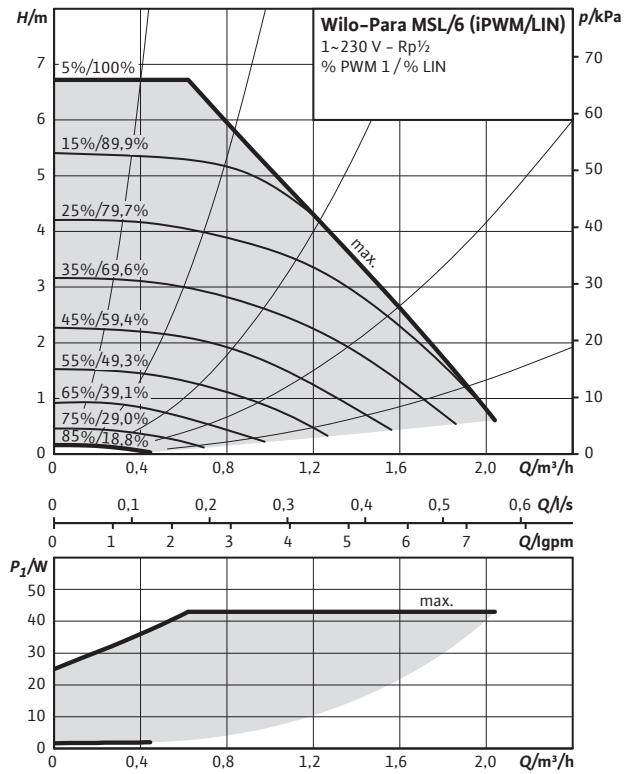

Pump curves

$\Delta p-v$ (variable)

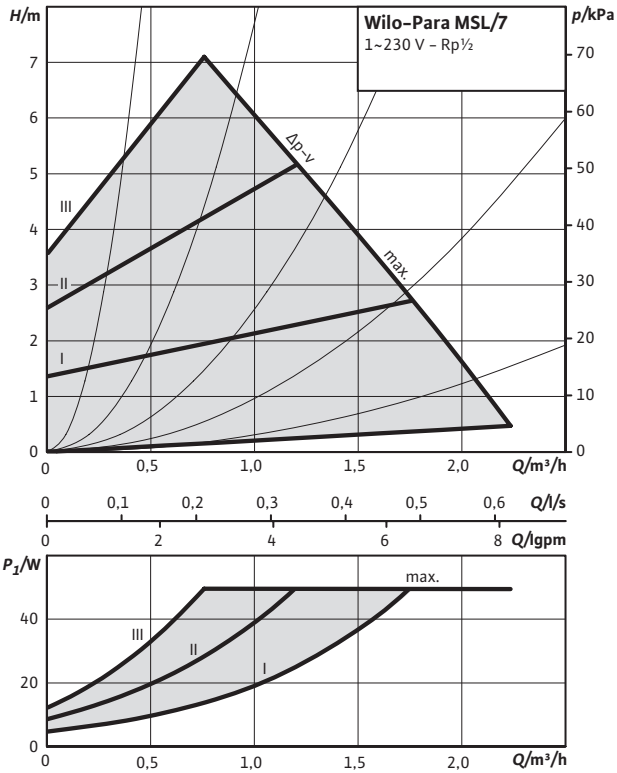

Pump curves

$\Delta p-c$ (constant)

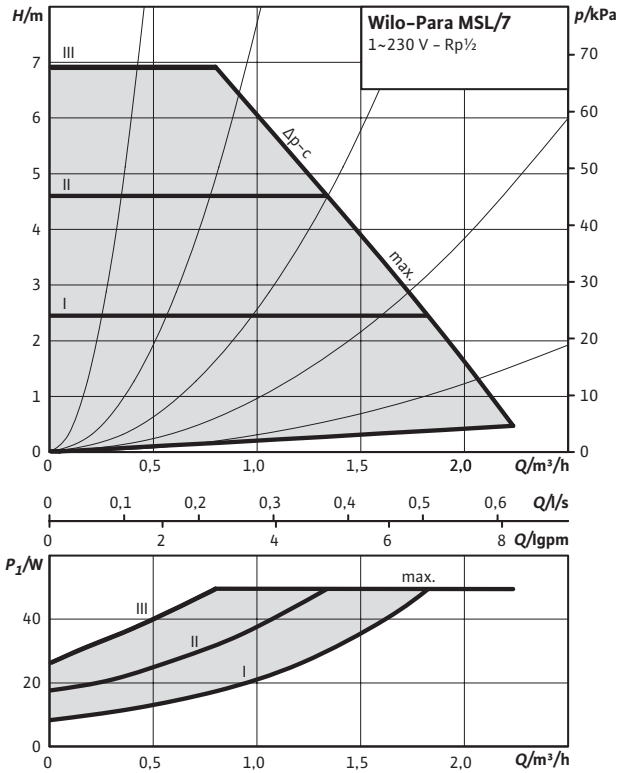

Pump curves

Constant speed I, II, III

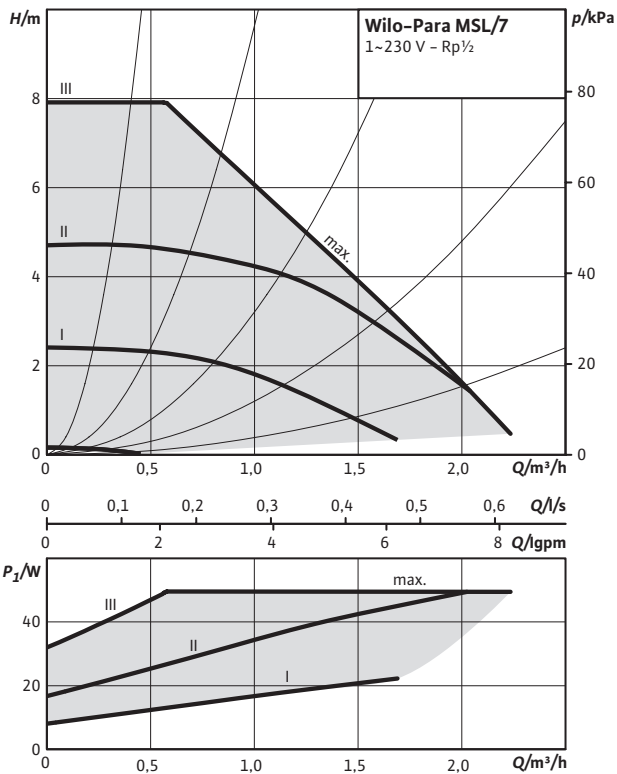

Pump curves

External control via PWM1/LIN

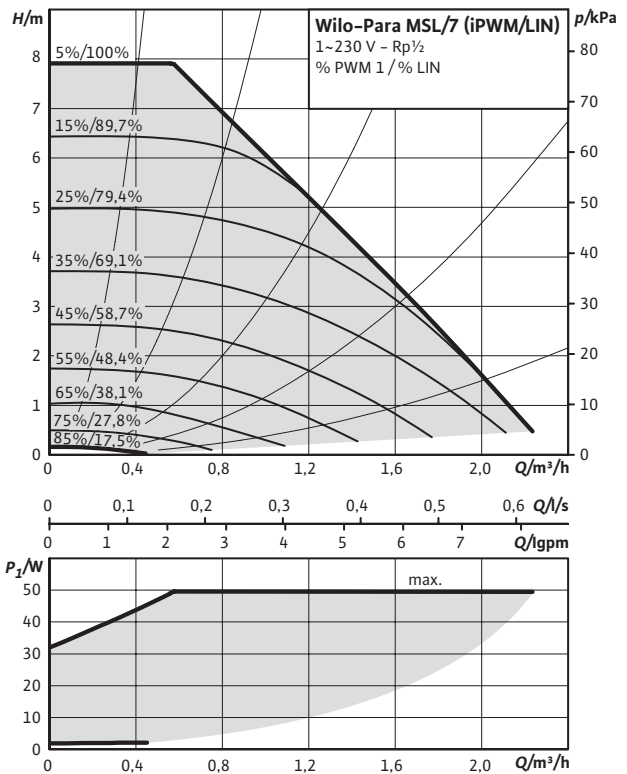

Pump curves

$\Delta p-v$ (variable)

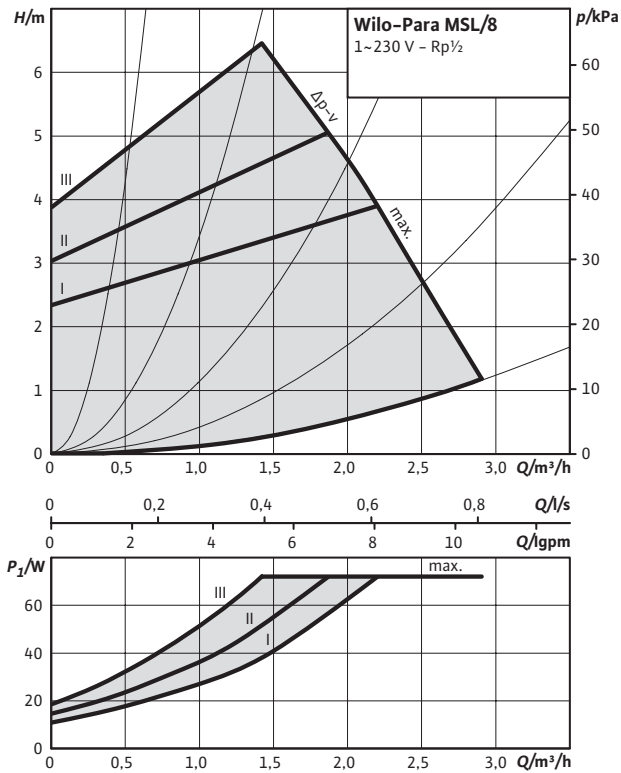

Pump curves

$\Delta p-c$ (constant)

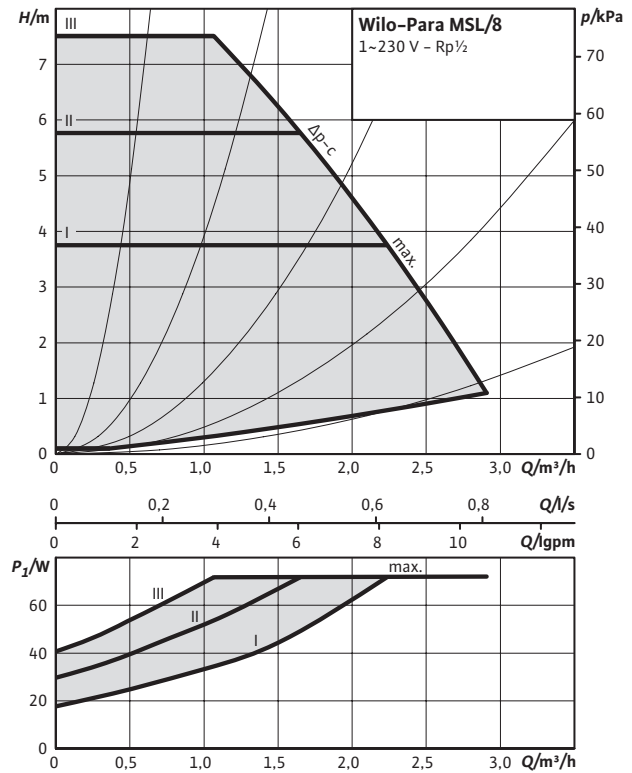

Pump curves

Constant speed I, II, III

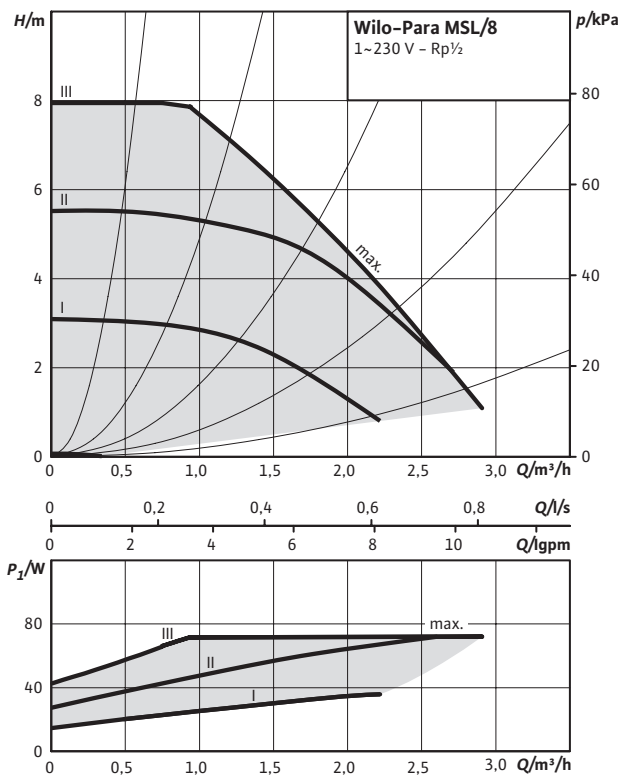

Pump curves

External control via PWM1/LIN

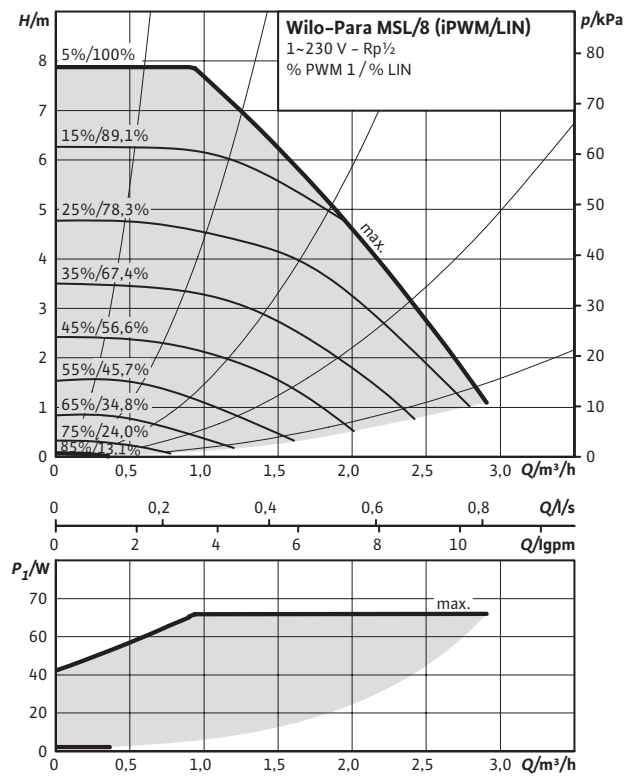

Dimension drawing SC

Wilo-Para MSL

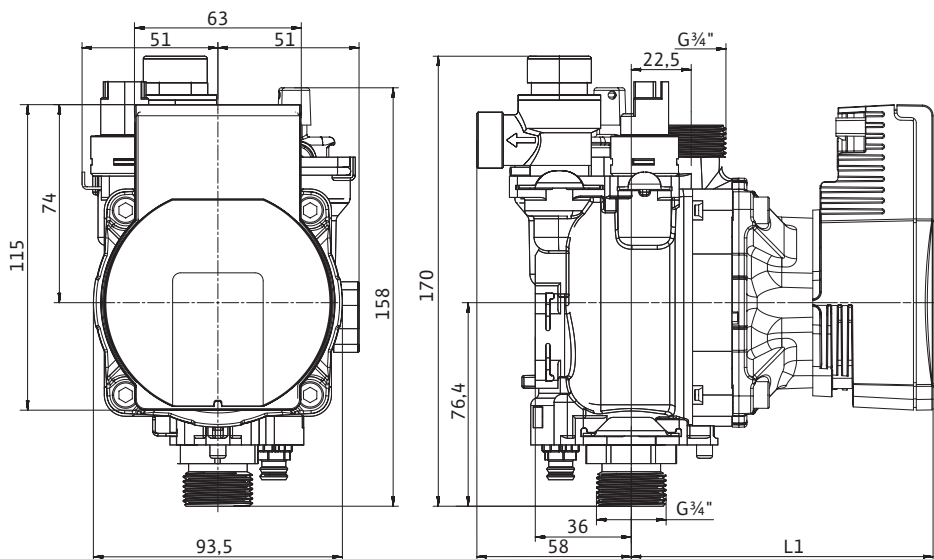

Technical data

Designation	Para MSL/6-43/SC	Para MSL/8-75/SC
Threaded pipe union		Rp 1/2
Thread		G 3/4
Weight approx. <i>m</i>	1 kg	1.2 kg
Dimensions <i>L1</i>	113 mm	125 mm
Materials		
Pump housing	PA6.6 with GF 30%	
Impeller	PP composite with GF 40%	
Pump shaft	Stainless steel	
Bearing	Carbon, metal impregnated	

Dimension drawing iPWM1/LIN

Wilo-Para MSL

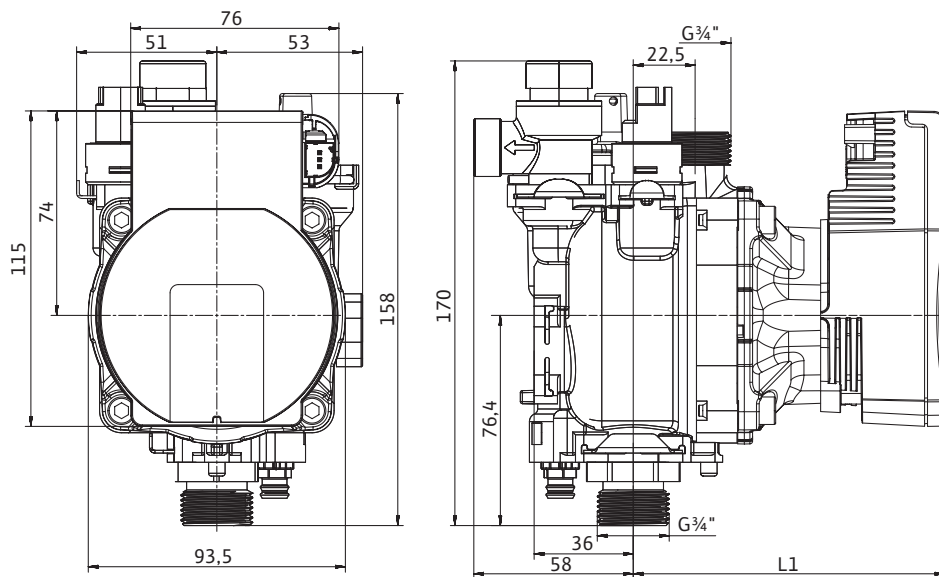

Technical data

Designation	Para MSL/6-43/*	Para MSL/7-50*	Para MSL/8-75*
Threaded pipe union		Rp 1/2	
Thread		G 3/4	
Overall length l_0		130 mm	180 mm
Weight approx. m		1 kg	1.2 kg
Dimensions $L1$		113 mm	125 mm

Materials

Pump housing	PA6.6 with GF 30%
Impeller	PP composite with GF 40%
Pump shaft	Stainless steel
Bearing	Carbon, metal impregnated

*iPWM1 or LIN

Wilo-Para MSL - Screwing instructions

Maximal torque on connections G 1", 1 1/4", 1 1/2" : 40 Nm

Optional connections

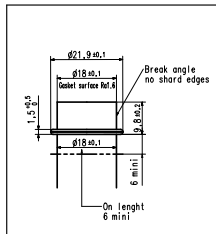

O-RING
 $\phi 17.86 \times \phi 2.62$
EPDM 70Sh



Wilo Intec 4517422

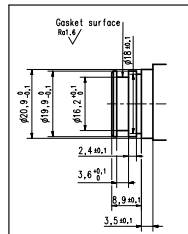

O-RING
 $\phi 15.88 \times \phi 2.62$
EPDM 70Sh



Wilo Intec 4517422

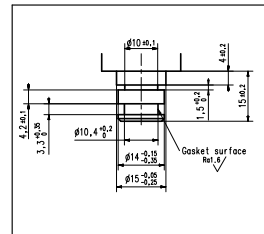

O-RING
 $\phi 9.6 \times \phi 2.4$
EPDM 70Sh



Wilo Intec 4517731

For threaded
Nut G3/4* Maximal torque 30Nm
Screwed on minimal 3 threads

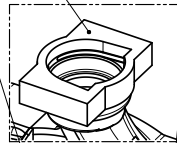

For Screw M5

Lateral connection

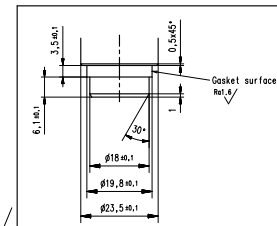

O-RING
 $\phi 18.72 \times \phi 2.62$
EPDM 70Sh

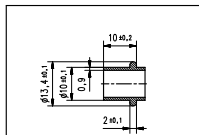

O-RING
 $\phi 9.6 \times \phi 2.4$
EPDM 70Sh



Wilo Intec 4517731

Optional

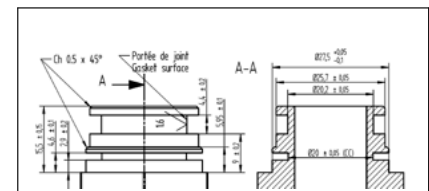
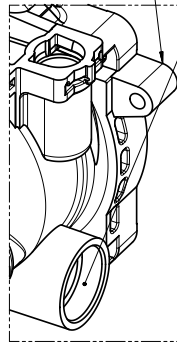

O-RING
 $\phi 19.8 \times \phi 3.6$
EPDM 80Sh



Wilo Intec 4513389
4520668 with lateral connection

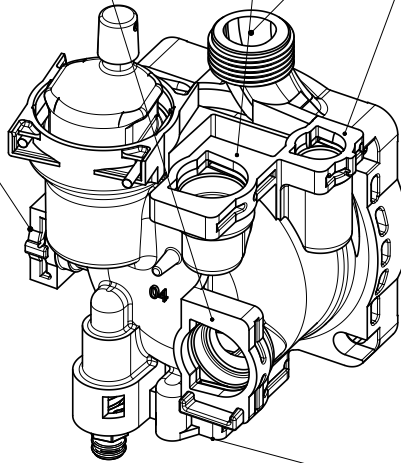

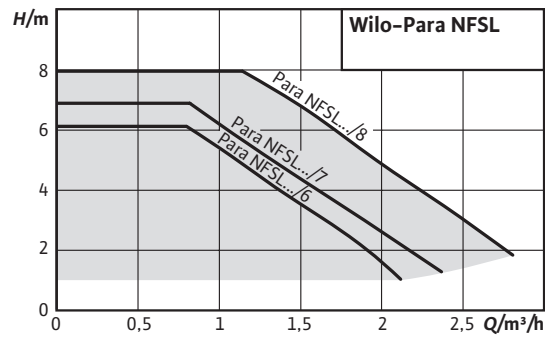

Wilo-Para NFSL



Motor data SC

Para	Speed	EEI	Power consumption 1~230 V	Current at 1~230V	Motor protection
	<i>n</i> rpm		<i>P</i> ₁ W	<i>I</i> A	
NFSL/6-43/SC	2430 - 4300	≤ 0.20	3-43	0.04 - 0.44	integrated
NFSL/7-50/SC	2580 - 4700	≤ 0.20	6-50	0.07 - 0.44	integrated
NFSL/8-75/SC	3000 - 4800	≤ 0.21	10-75	0.03 - 0.66	integrated

Motor data iPWM1/LIN

Para	Speed	EEI	Power consumption 1~230 V	Current at 1~230V	Motor protection
	<i>n</i> rpm		<i>P</i> ₁ W	<i>I</i> A	
NFSL/6-43*	700 - 4300	≤ 0.20	1-43	0.04 - 0.44	integrated
NFSL/7-50*	700 - 4700	≤ 0.20	1-50	0.02 - 0.44	integrated
NFSL/8-75*	500 - 4800	≤ 0.21	2-75	0.03 - 0.66	integrated

*iPWM1 or LIN

Pump curves

$\Delta p-v$ (variable)

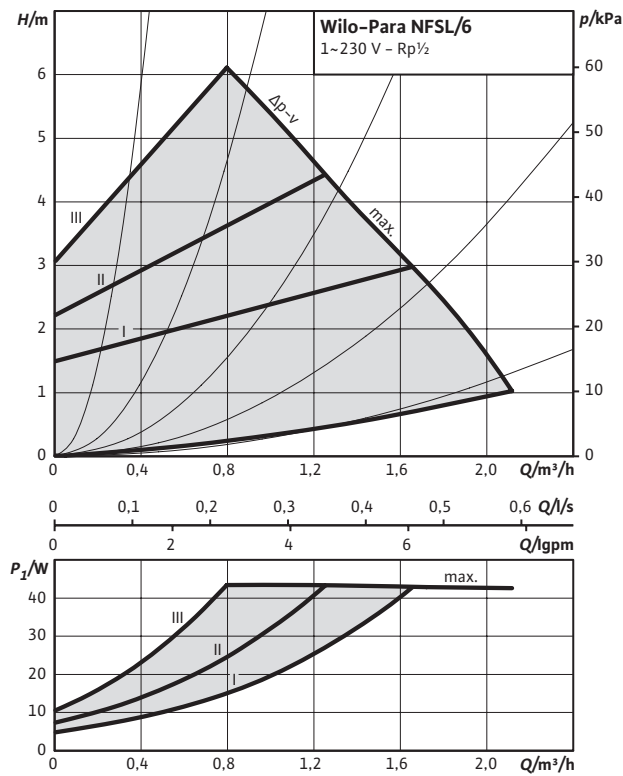

Pump curves

$\Delta p-c$ (constant)

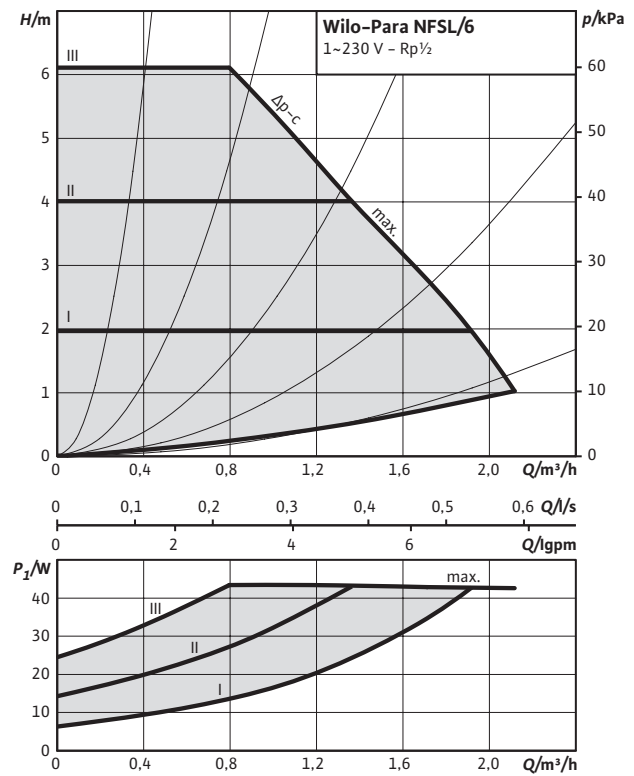

Pump curves

Constant speed I, II, III

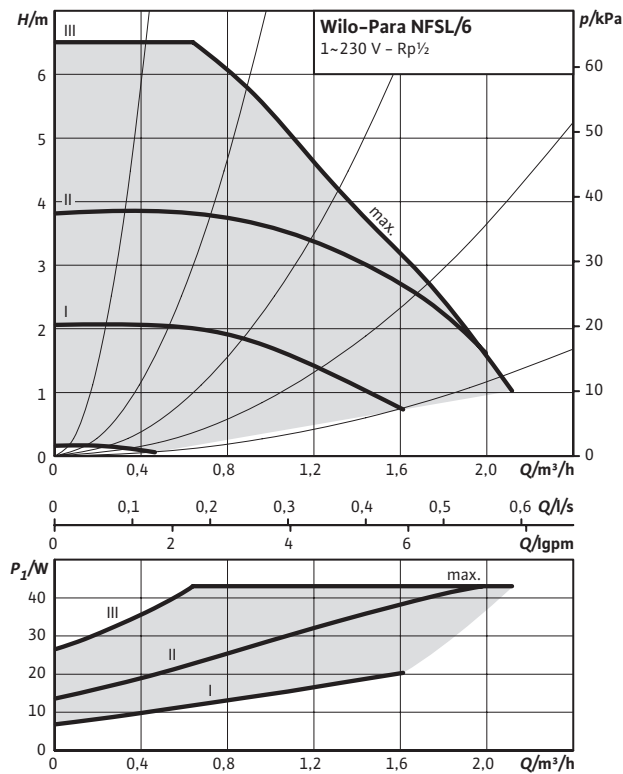

Pump curves

External control via PWM1/LIN

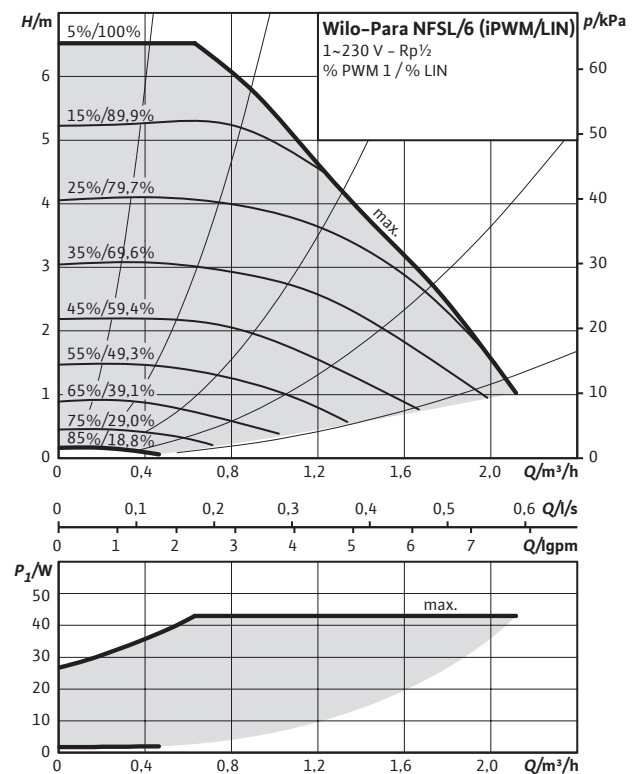

Pump curves

$\Delta p-v$ (variable)

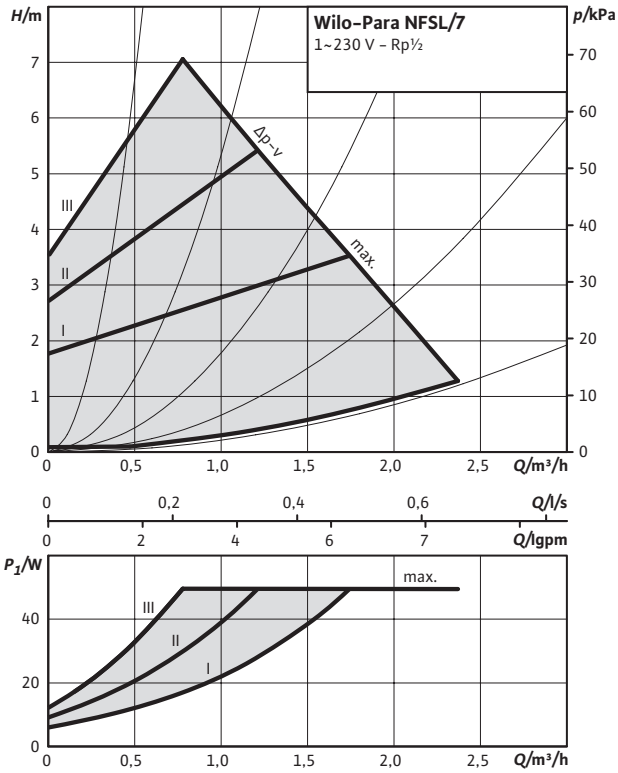

Pump curves

$\Delta p-c$ (constant)

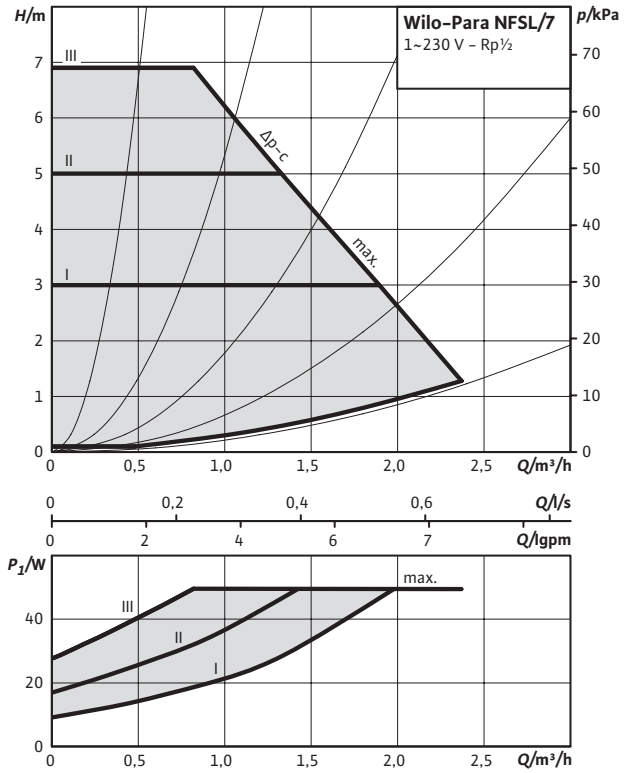

Pump curves

Constant speed I, II, III

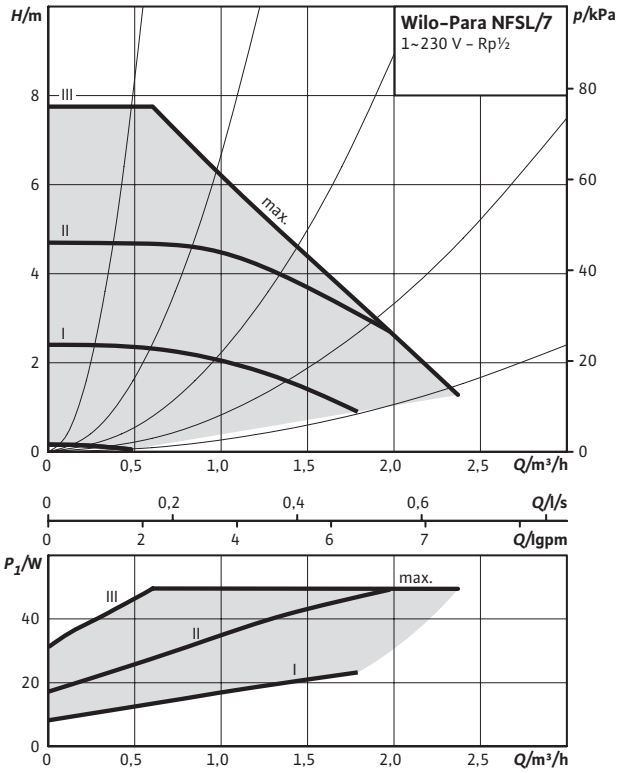

Pump curves

External control via PWM1/LIN

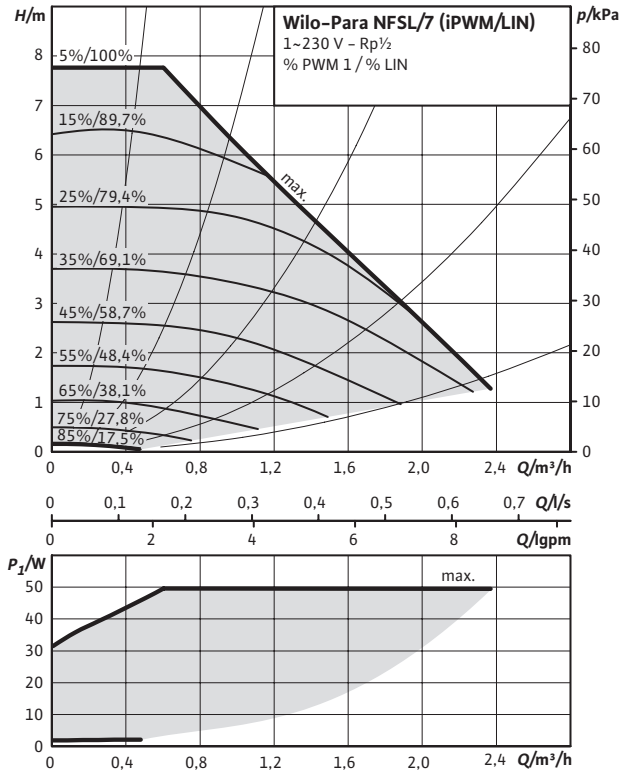

Pump curves

$\Delta p-v$ (variable)

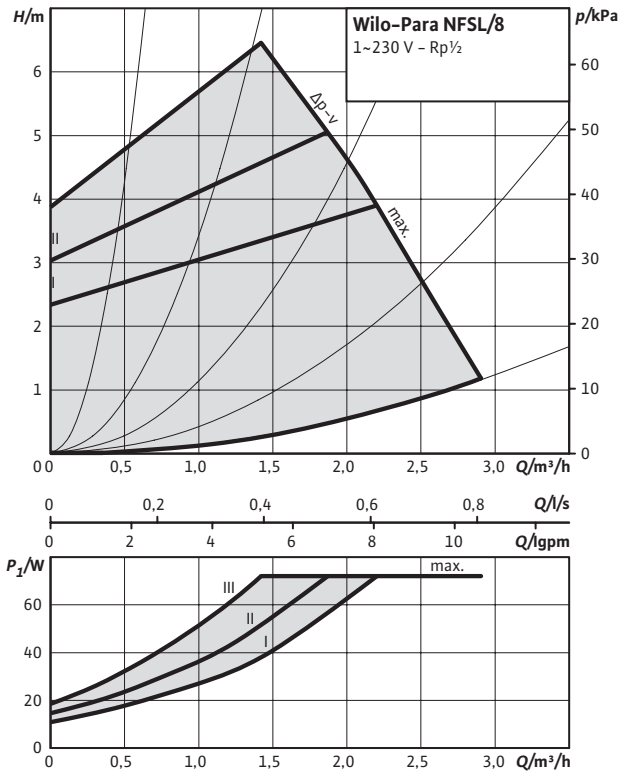

Pump curves

$\Delta p-c$ (constant)

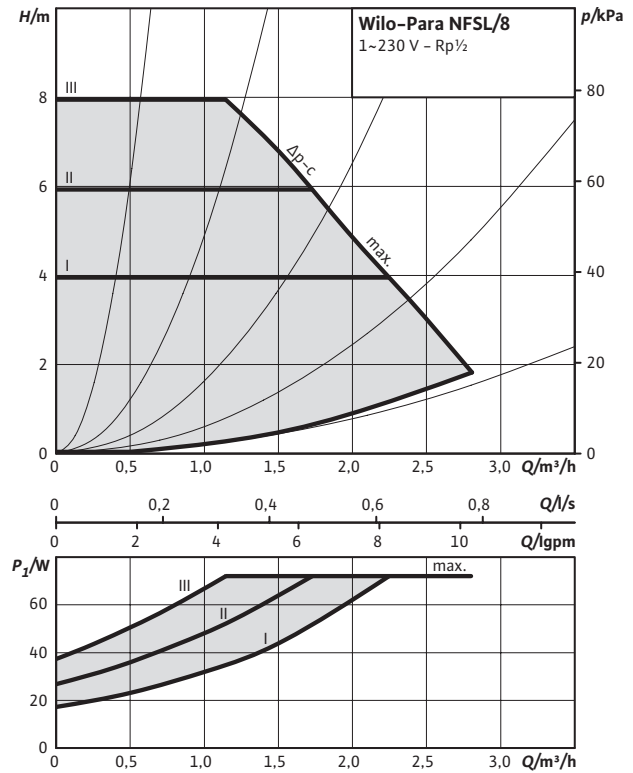

Pump curves

Constant speed I, II, III

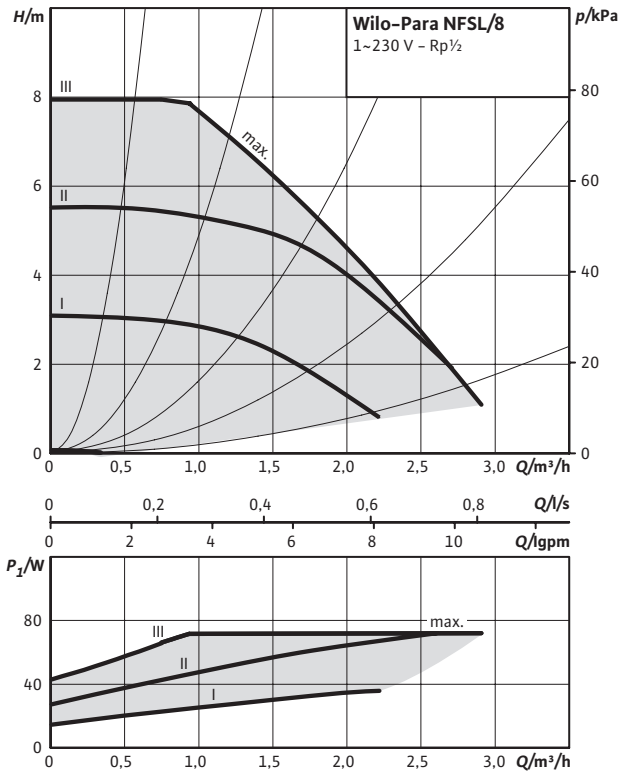

Pump curves

External control via PWM1/LIN

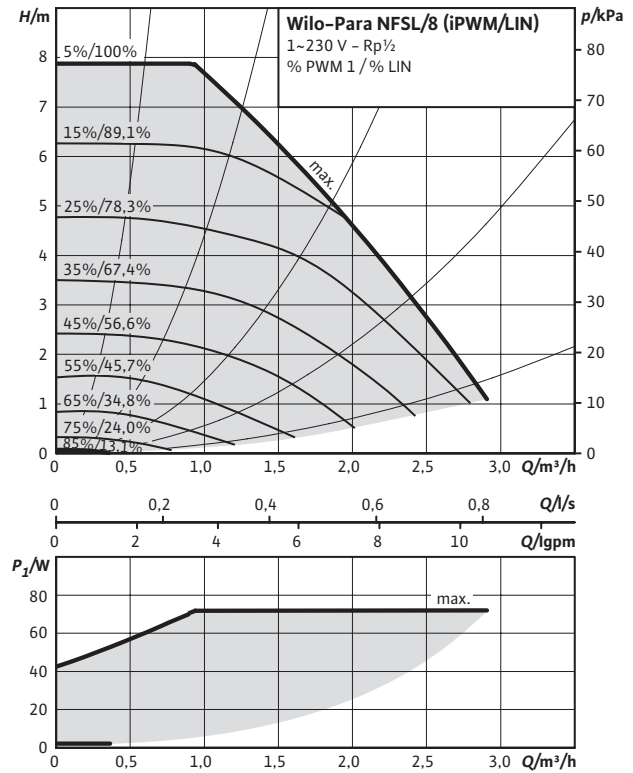

Dimension drawing SC

Wilo-Para NFSL

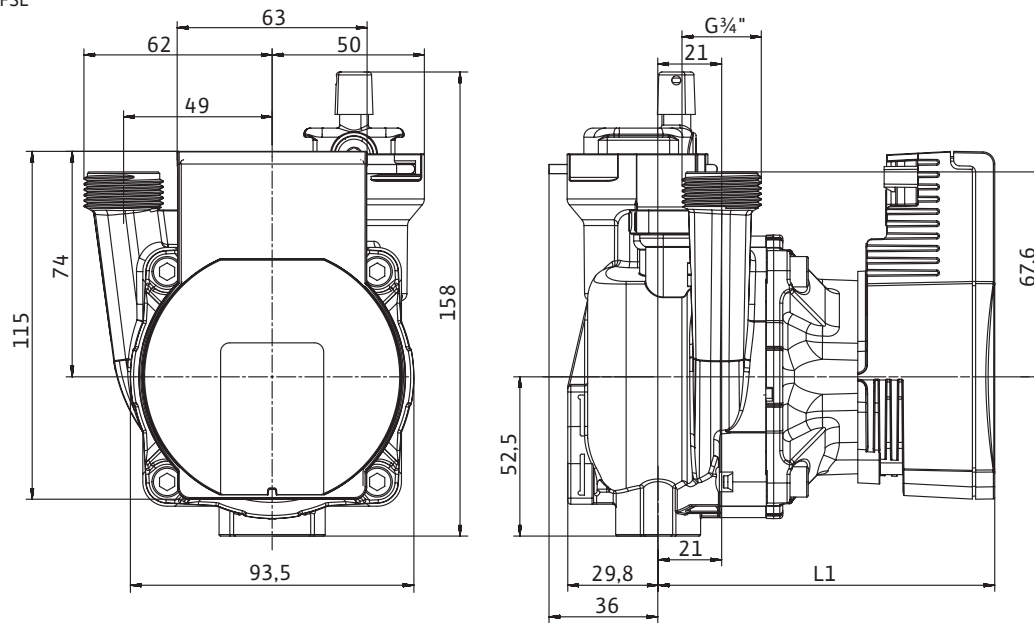

Technical data

Designation	Para NFSL/6-43/SC	Para NFSL/7-50/SC	Para NFSL/8-75/SC
Threaded pipe union		Rp 1/2	
Thread		G 3/4	
Weight approx. <i>m</i>		1 kg	1.2 kg
Dimensions <i>L1</i>		111 mm	123 mm
Materials			
Pump housing	PA6.6 with GF 30%		
Impeller	PP composite with GF 40%		
Pump shaft	Stainless steel		
Bearing	Carbon, metal impregnated		

Dimension drawing iPWM1/LIN

Wilo-Para NFSL

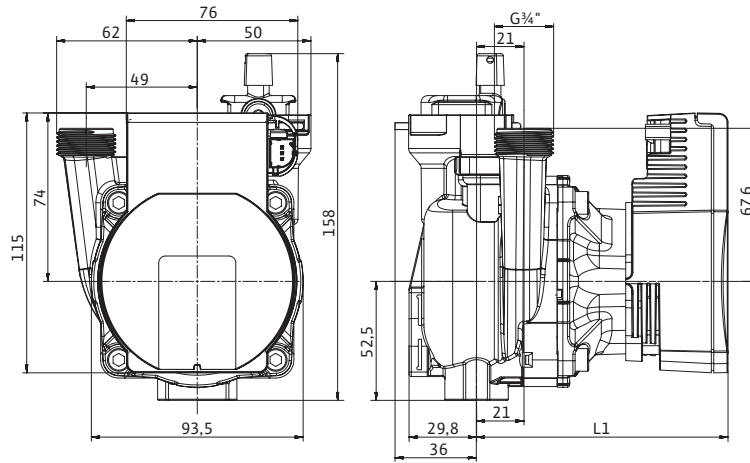

Technical data

Designation	Para NFSL/6-43*	Para NFSL/7-50*	Para NFSL/8-75*
Threaded pipe union		Rp 1/2	
Thread		G 3/4	
Weight approx. <i>m</i>		1 kg	1.2 kg
Dimensions <i>L1</i>		111 mm	123 mm

Materials

Pump housing	PA6.6 with GF 30%		
Impeller	PP composite with GF 40%		
Pump shaft	Stainless steel		
Bearing	Carbon, metal impregnated		

*iPWM1 or LIN

Optional connections

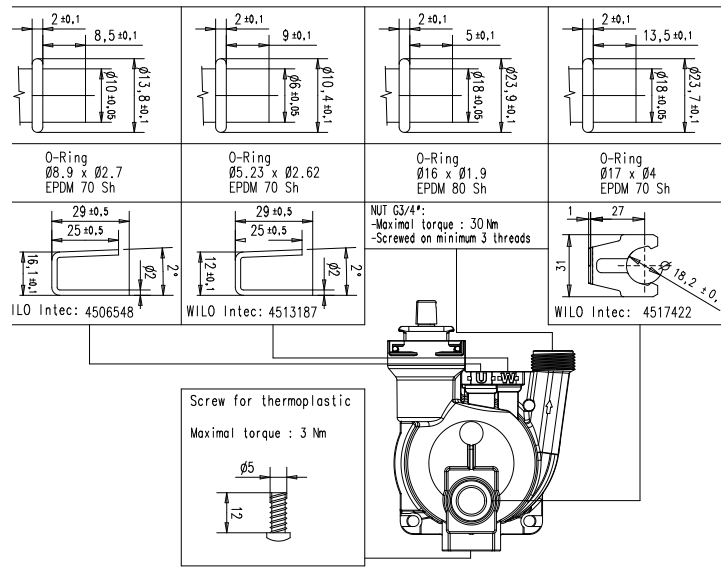

Wilo-Para NFSL – Screwing instructions

Maximal torque on connections G 1", 1 1/4", 1 1/2" : 40 Nm

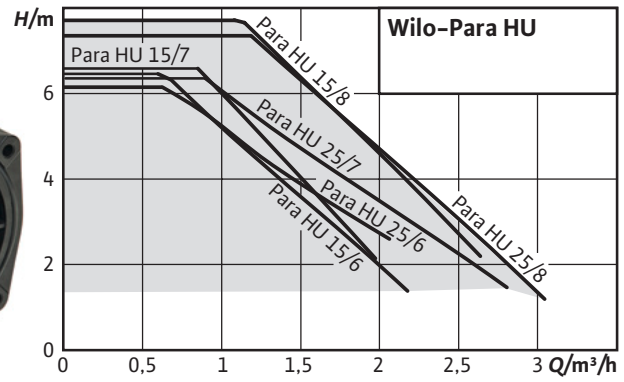

Wilo-Para HU



Motor data SC

Para	Speed	EEl	Power consumption 1-230 V	Current at 1~230V	Motor protection
	<i>n</i> rpm		<i>P_i</i> W	<i>I</i> A	
HU15/6-43/SC	2430 - 4300	≤ 0.20	3-43	0.04 - 0.44	integrated
HU25/6-43/SC	2430 - 4300	≤ 0.20	3-43	0.04 - 0.44	integrated
HU15/7-50/SC	2580 - 4700	≤ 0.20	6-50	0.07 - 0.44	integrated
HU25/7-50/SC	2580 - 4700	≤ 0.20	6-50	0.07 - 0.44	integrated
HU15/8-75/SC	3000 - 4800	≤ 0.21	10-75	0.03 - 0.66	integrated
HU25/8-75/SC	3000 - 4800	≤ 0.21	10-75	0.03 - 0.66	integrated

Motor data iPWM1/LIN

Para	Speed	EEl	Power consumption 1-230 V	Current at 1~230V	Motor protection
	<i>n</i> rpm		<i>P_i</i> W	<i>I</i> A	
HU15/6-43*	700 - 4300	≤ 0.20	1-43	0.04 - 0.44	integrated
HU25/6-43*	700 - 4300	≤ 0.20	1-43	0.04 - 0.44	integrated
HU15/7-50*	700 - 4700	≤ 0.20	1-50	0.02 - 0.44	integrated
HU25/7-50*	700 - 4700	≤ 0.20	1-50	0.02 - 0.44	integrated
HU15/8-75*	500 - 4800	≤ 0.21	2-75	0.03 - 0.66	integrated
HU25/8-75*	500 - 4800	≤ 0.21	2-75	0.03 - 0.66	integrated

*iPWM1 or LIN

Pump curves

$\Delta p-v$ (variable)

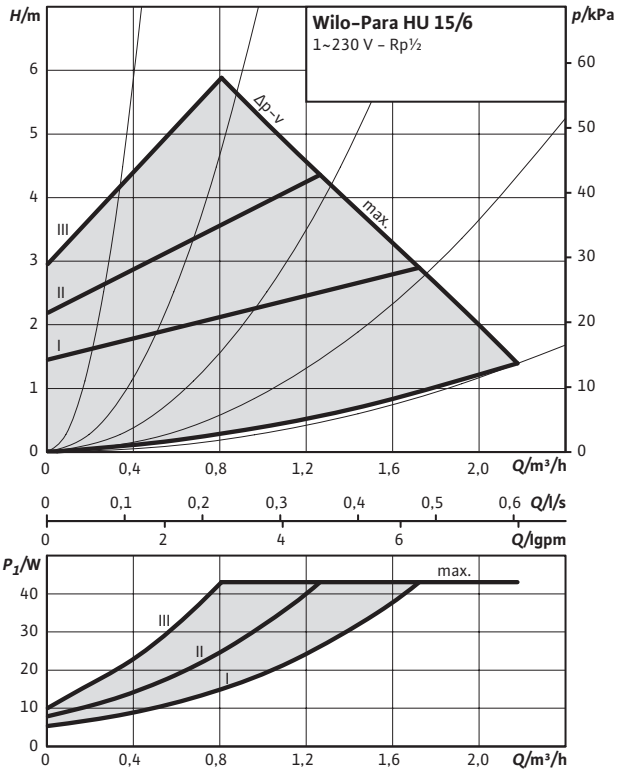

Pump curves

$\Delta p-c$ (constant)

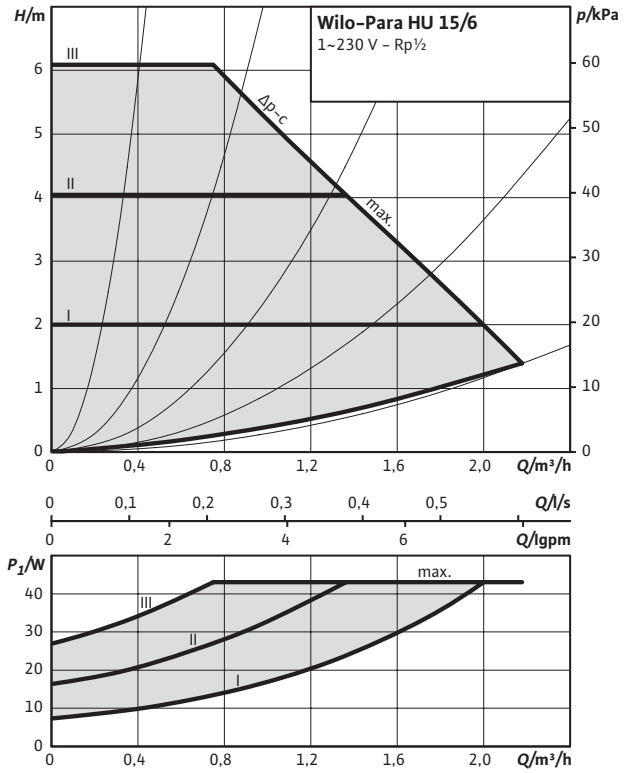

Pump curves

Constant speed I, II, III

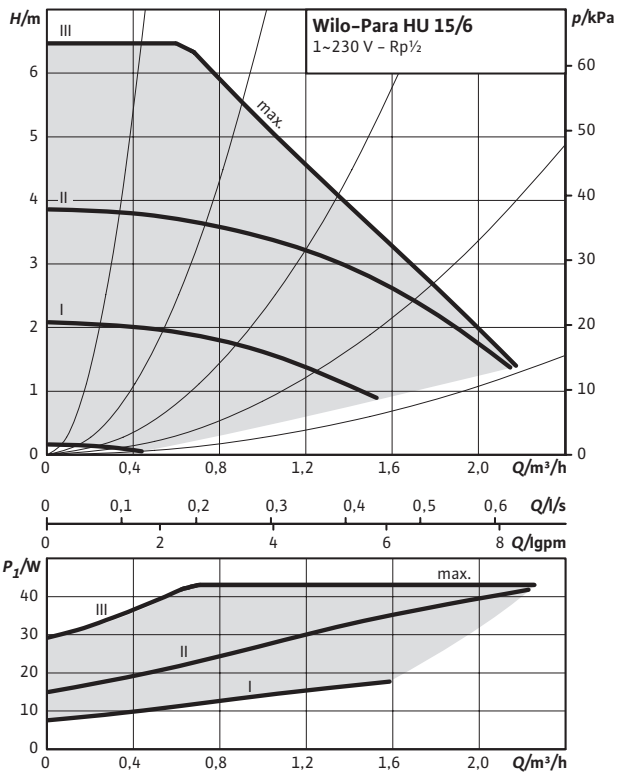

Pump curves

External control via PWM1/LIN

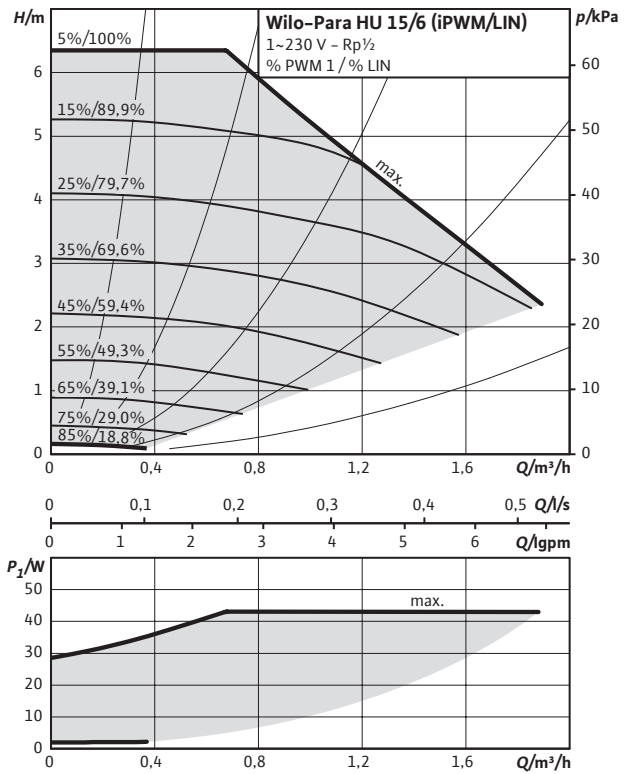

Pump curves

$\Delta p-v$ (variable)

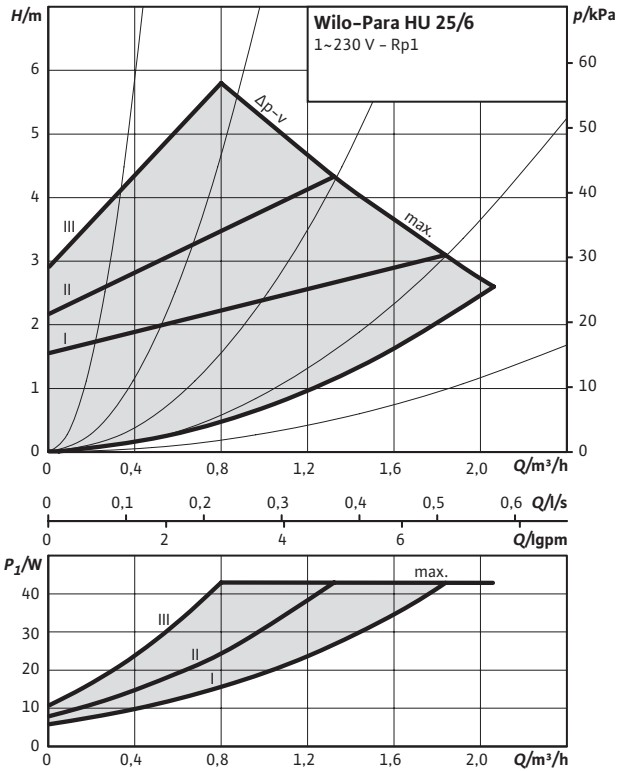

Pump curves

$\Delta p-c$ (constant)

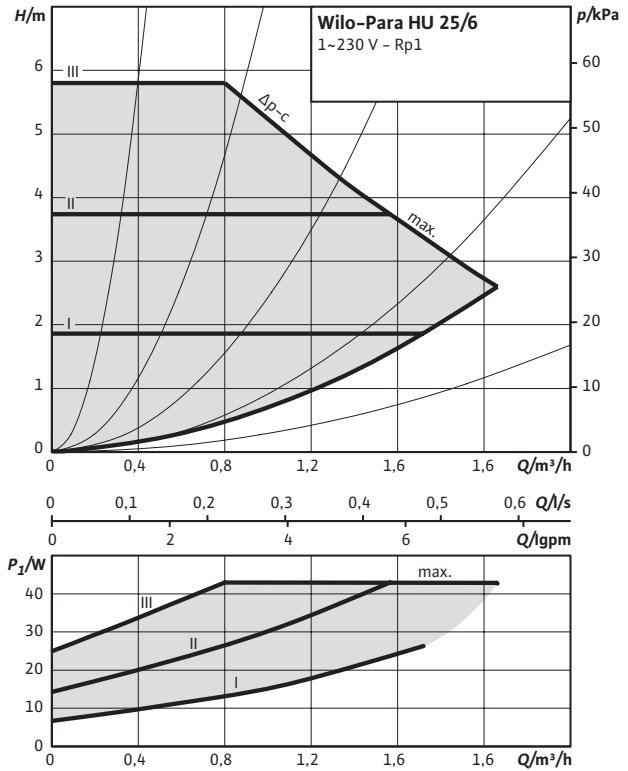

Pump curves

Constant speed I, II, III

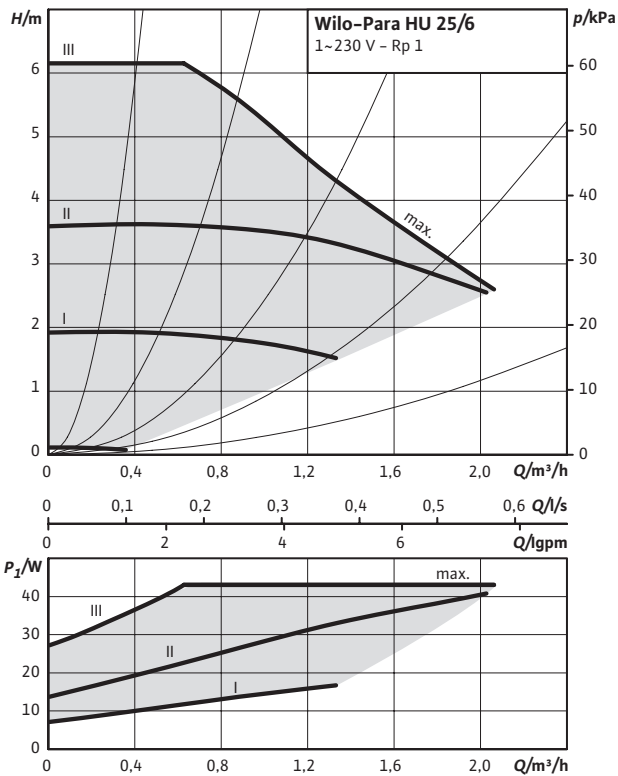

Pump curves

External control via PWM1/LIN

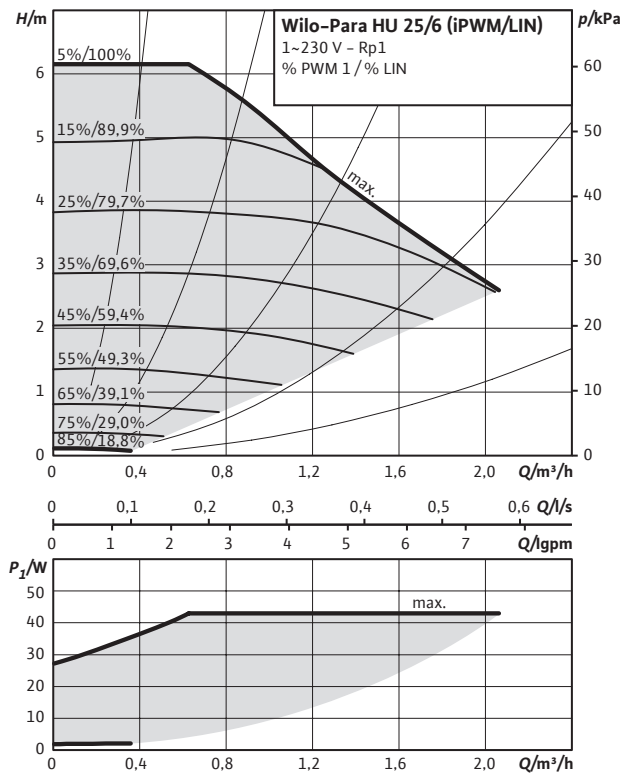

Pump curves

$\Delta p-v$ (variable)

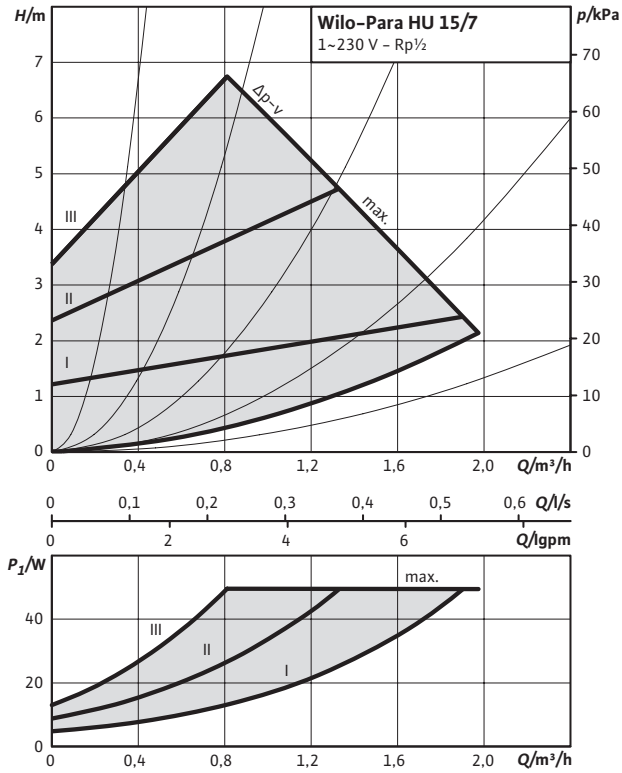

Pump curves

$\Delta p-c$ (constant)

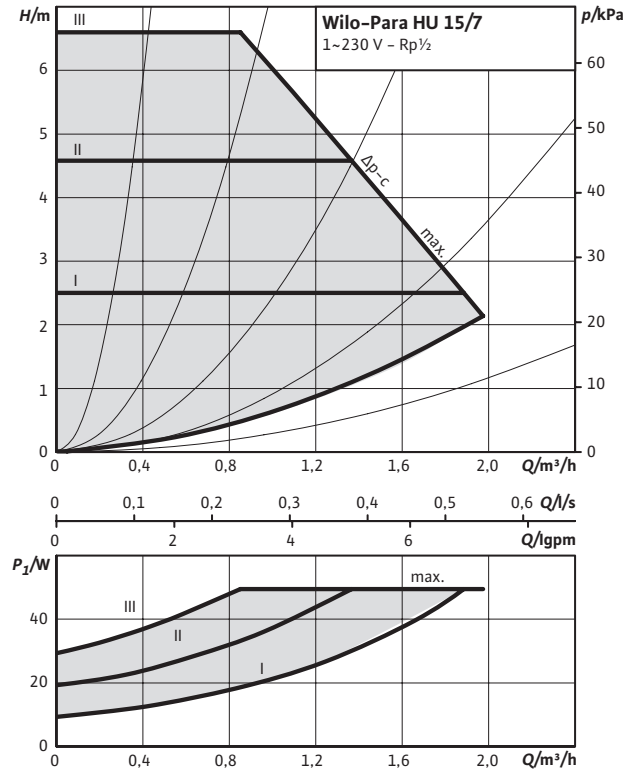

Pump curves

Constant speed I, II, III

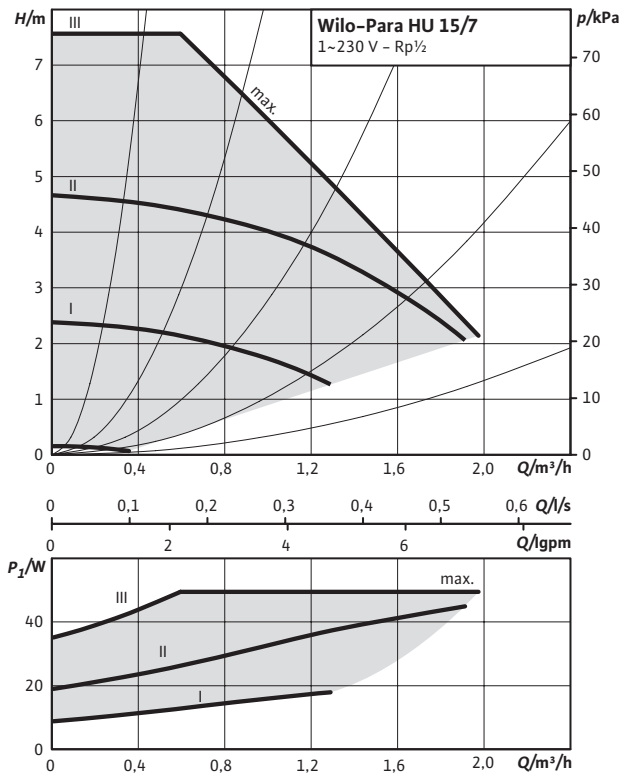

Pump curves

External control via PWM1/LIN

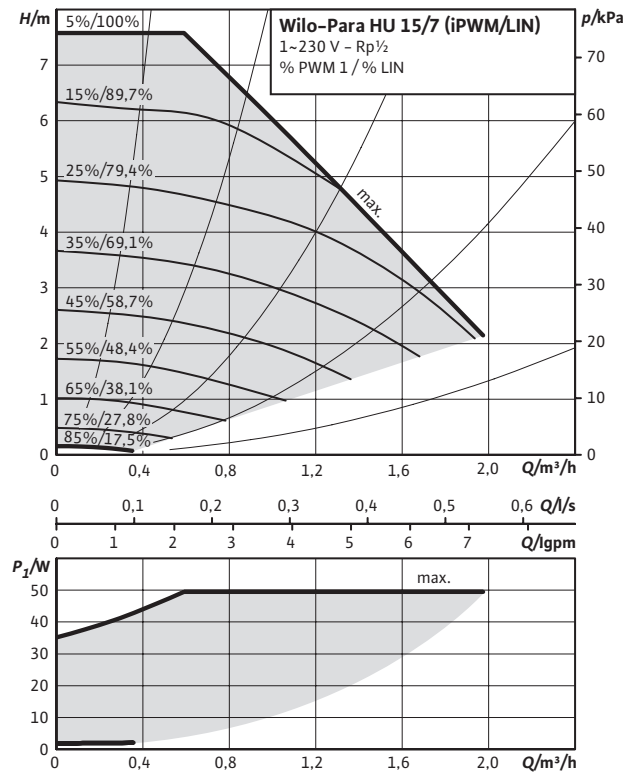

Pump curves

$\Delta p-v$ (variable)

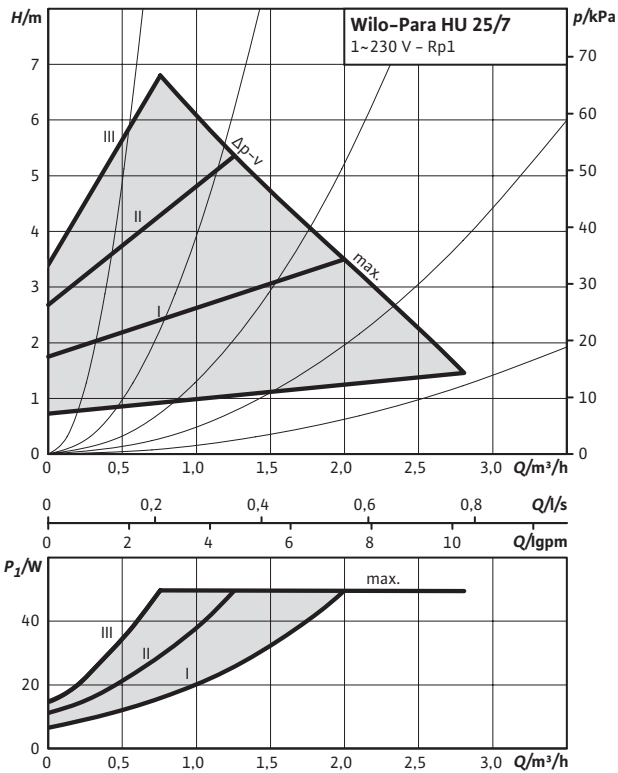

Pump curves

$\Delta p-c$ (constant)

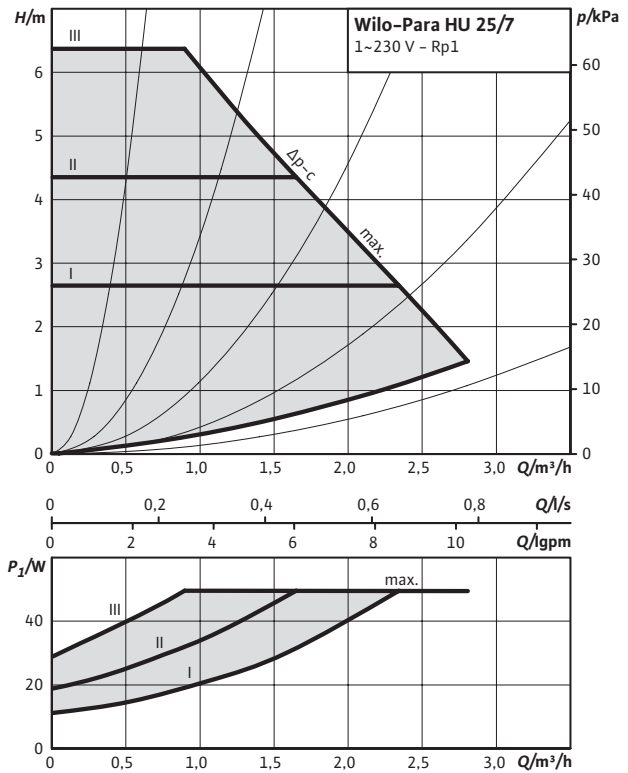

Pump curves

Constant speed I, II, III

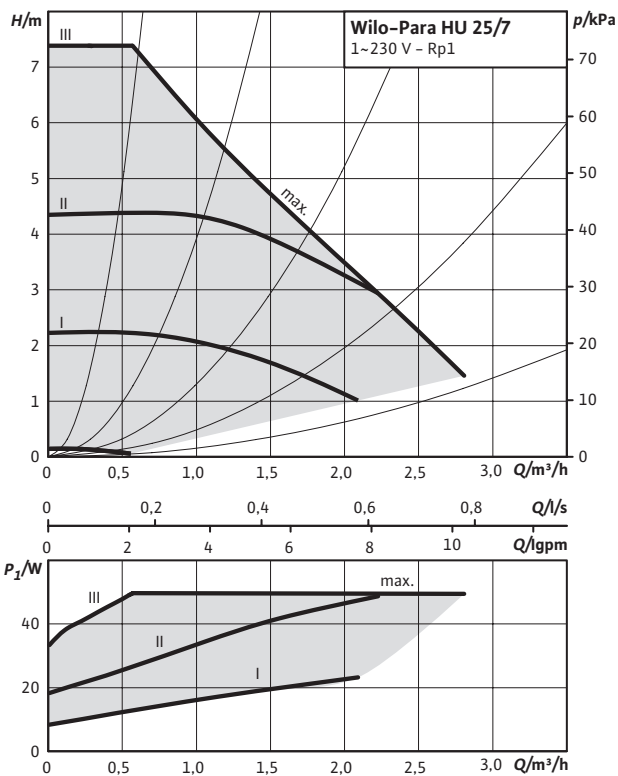

Pump curves

External control via PWM1/LIN

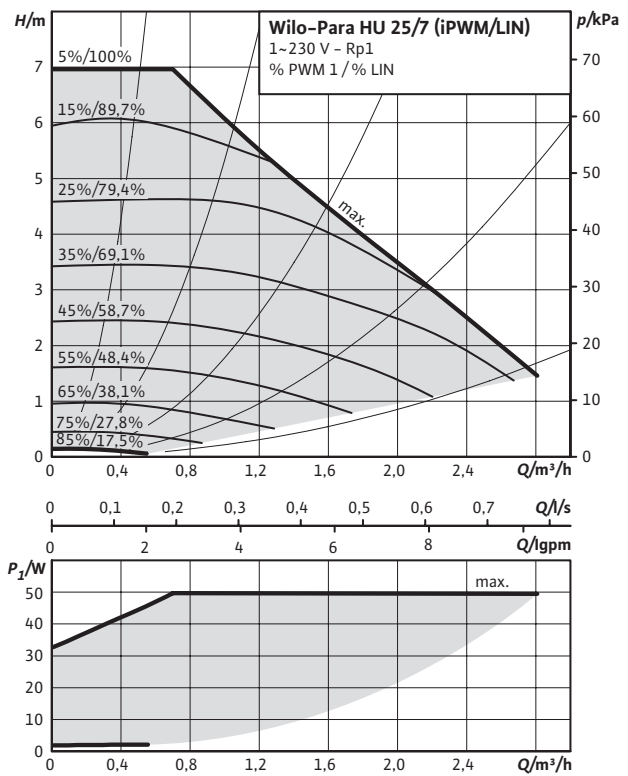

Pump curves

$\Delta p-v$ (variable)

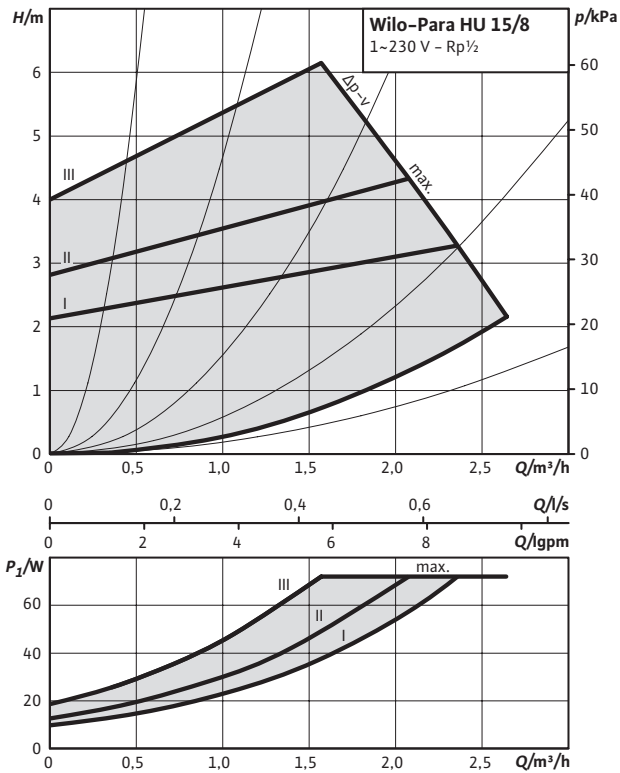

Pump curves

$\Delta p-c$ (constant)

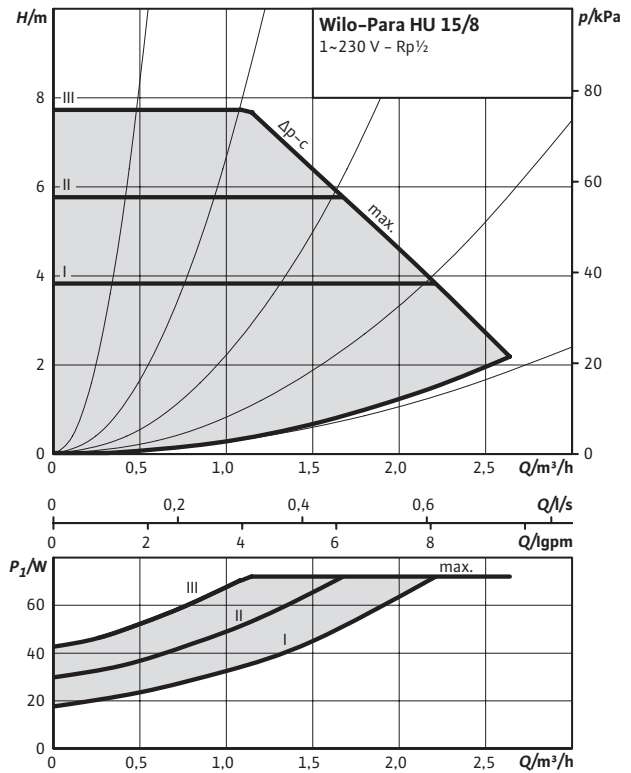

Pump curves

Constant speed I, II, III

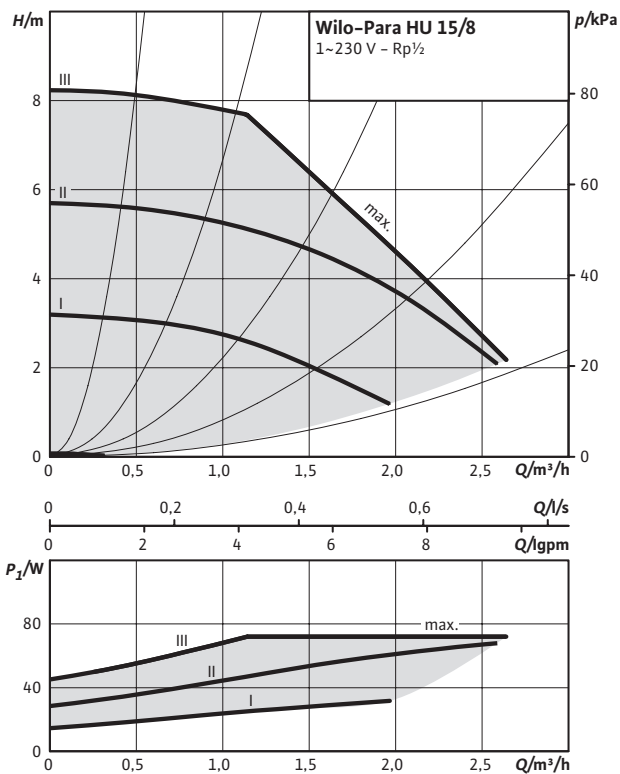

Pump curves

External control via PWM1/LIN

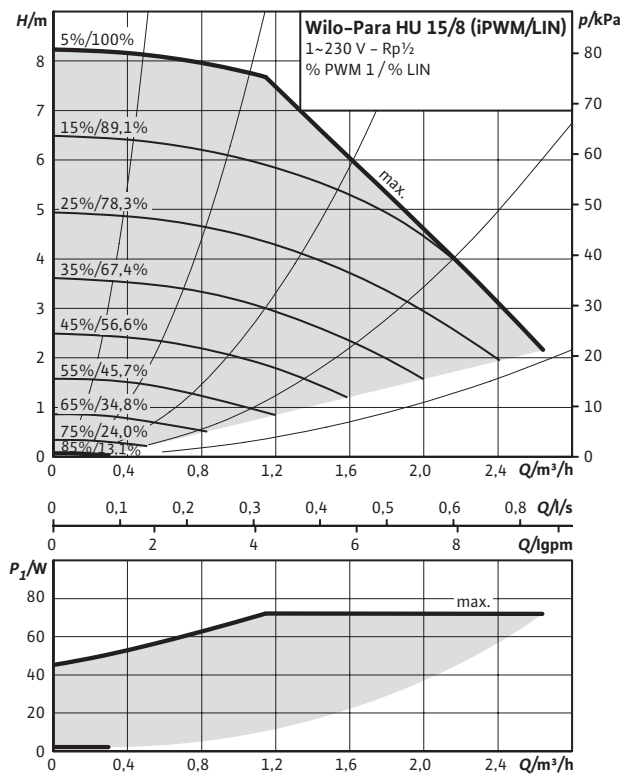

Pump curves

$\Delta p-v$ (variable)

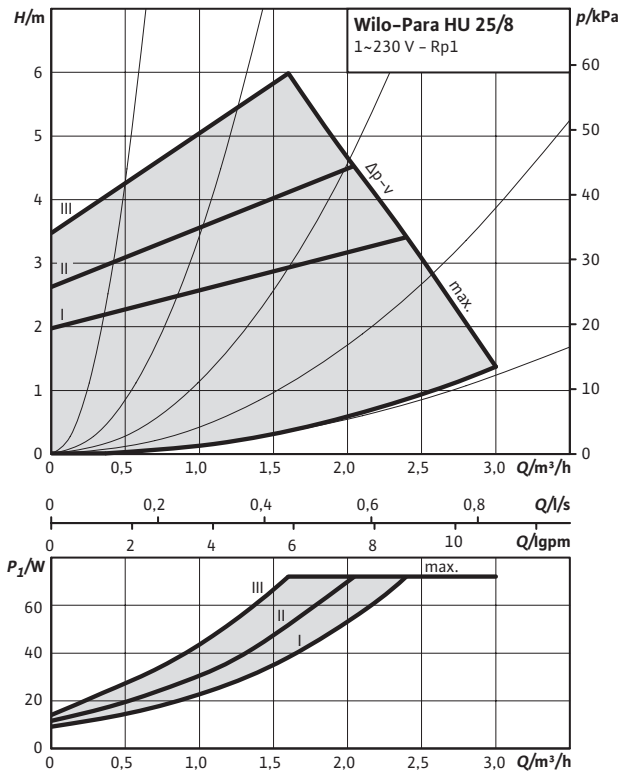

Pump curves

$\Delta p-c$ (constant)

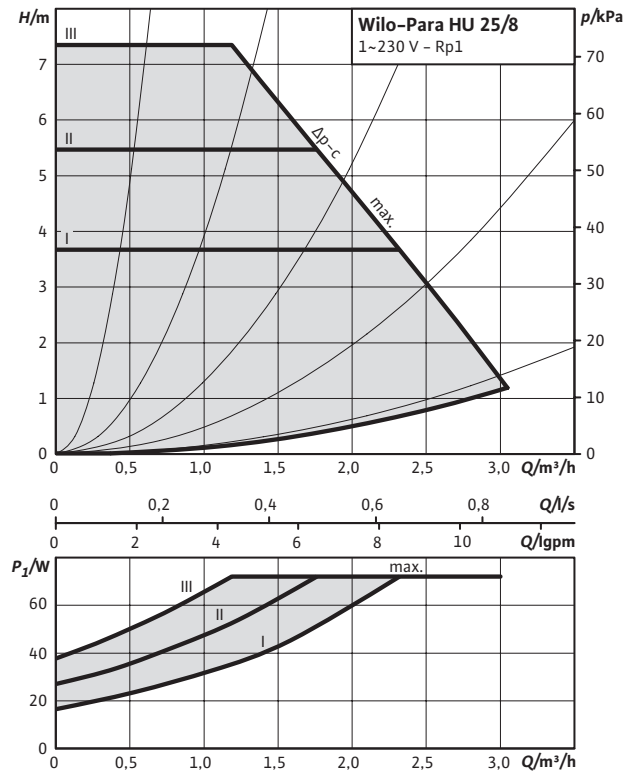

Pump curves

Constant speed I, II, III

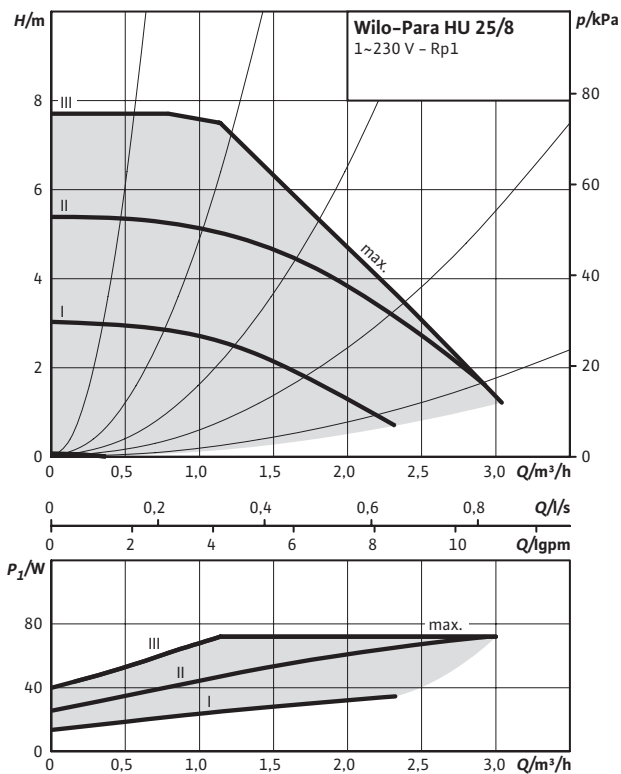

Pump curves

External control via PWM1/LIN

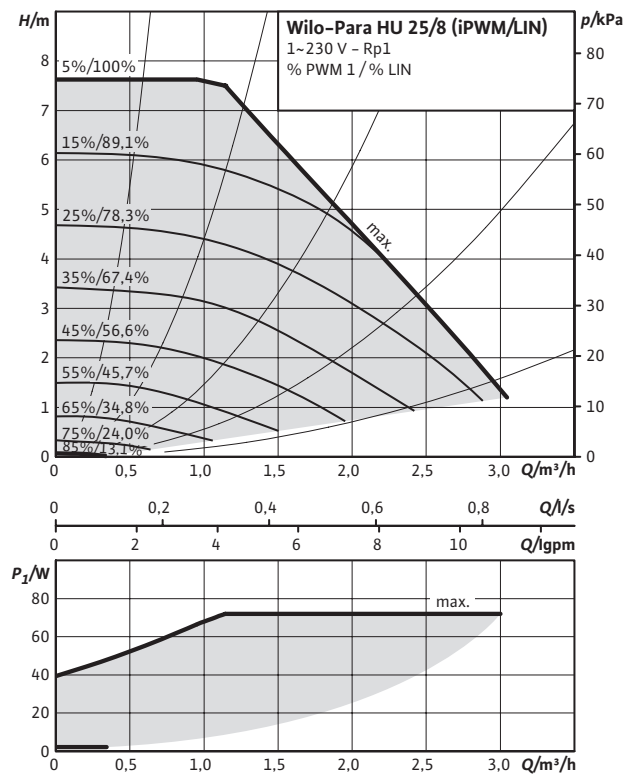

Dimension drawing SC

Wilo-Para HU 15

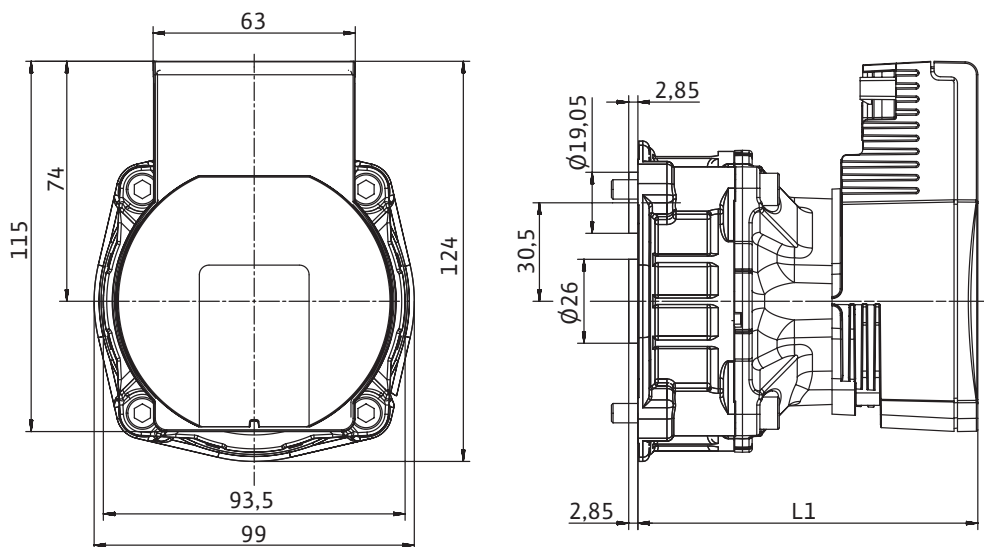

Wilo-Para HU 25

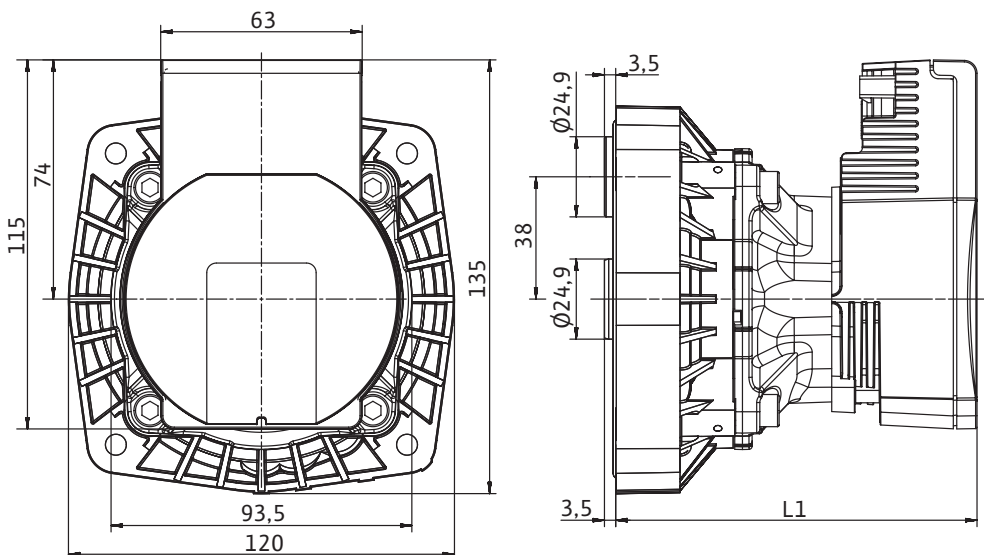

Technical data

Designation	Para HU15/6-43/SC	Para HU15/7-50/SC	Para HU15/8-75/SC
Weight approx. <i>m</i>		0.9 kg	1.1 kg
Dimensions <i>L1</i>		105 mm	117 mm

Technical data

Designation	Para HU25/6-43/SC	Para HU25/7-50/SC	Para HU25/8-75/SC
Weight approx. <i>m</i>		1 kg	1.2 kg
Dimensions <i>L1</i>		112 mm	124 mm

Materials

Pump housing	PA6.6 with GF 30%
Impeller	PP composite with GF 40%
Pump shaft	Stainless steel
Bearing	Carbon, metal impregnated

Dimension drawing iPWM1/LIN

Wilo-Para HU 15

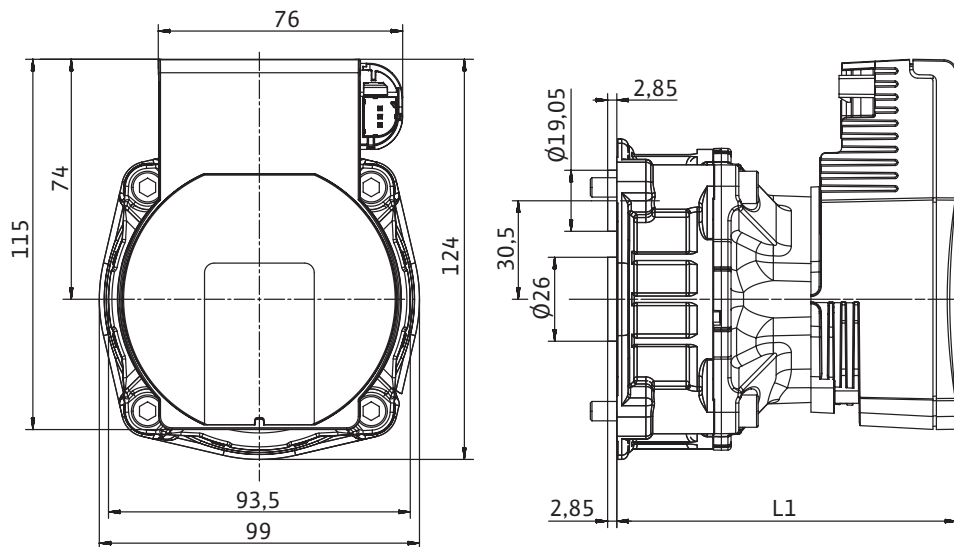

Wilo-Para HU 25

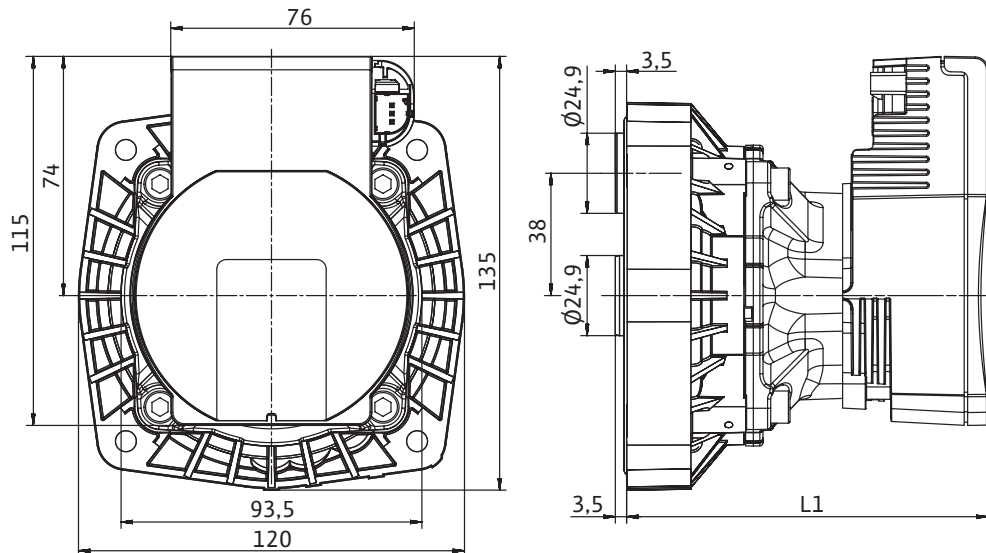

Technical data

Designation	Para HU15/6-43*	Para HU15/7-50*	Para HU15/8-75*
Weight approx. <i>m</i>		0.9 kg	1.1 kg
Dimensions <i>L1</i>		105 mm	117 mm

Technical data

Designation	Para HU25/6-43*	Para HU25/7-50*	Para HU25/8-75*
Weight approx. <i>m</i>		1 kg	1.2 kg
Dimensions <i>L1</i>		112 mm	124 mm

Materials

Pump housing	PA6.6 with GF 30%
Impeller	PP composite with GF 40%
Pump shaft	Stainless steel
Bearing	Carbon, metal impregnated

*iPWM1 or LIN

Wilo-Para HU 15 – Screwing instructions

Water tightness of the circulator is guaranteed if:

- all its parts are correctly assembled
- the 4 screws are screwed according to the following instruction:



Screw first simultaneously two opposite screws to a torque of 3 Nm



Then screw simultaneously the two opposite screws to a torque of 3 Nm



Screw first simultaneously two opposite screws to a torque of 5 Nm



Then screw simultaneously the two opposite screws to a torque of 5 Nm

Optional connections HU 15

The HU15 KU should only be used in this orientation with the pressure outlet at 12 o'clock.

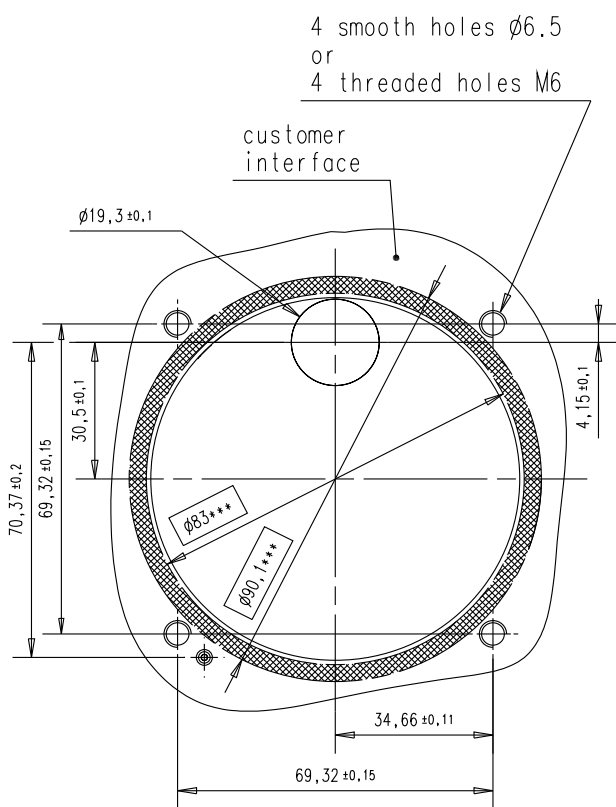

*** Zone with hatches Surface B
Gasket compression surface

Zone without hatches beneath surface B

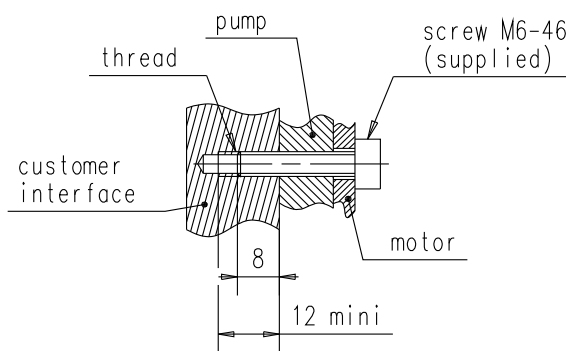

OR

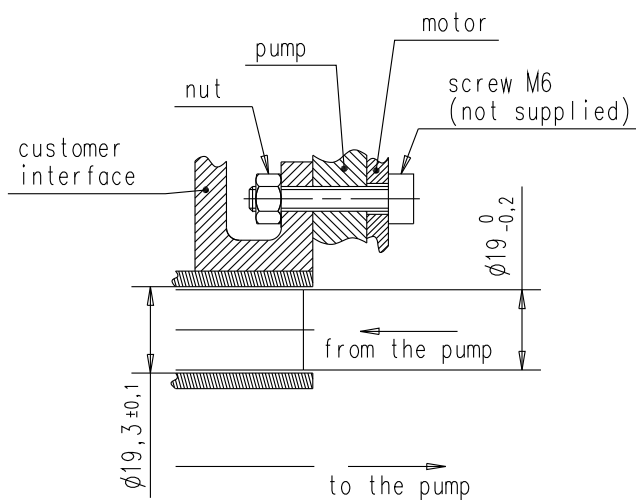

Wilo-Para HU 25 – Screwing instructions

Water tightness of the circulator is guaranteed if:

- all its parts are correctly assembled
- the 4 screws are screwed according to the following instruction:



Screw first simultaneously two opposite screws to a torque of 3 Nm



Then screw simultaneously the two opposite screws to a torque of 3 Nm



Screw first simultaneously two opposite screws to a torque of 5 Nm



Then screw simultaneously the two opposite screws to a torque of 5 Nm

Optional connections HU 25

The HU25 KU should only be used in this orientation with the pressure outlet at 12 o'clock.

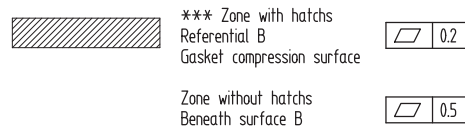
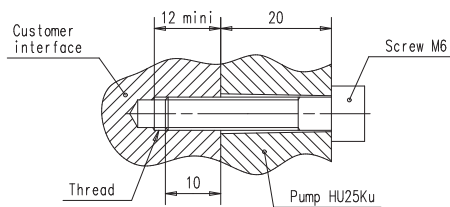
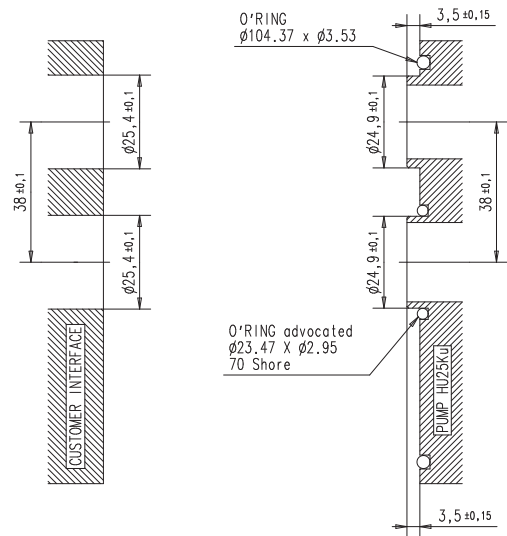
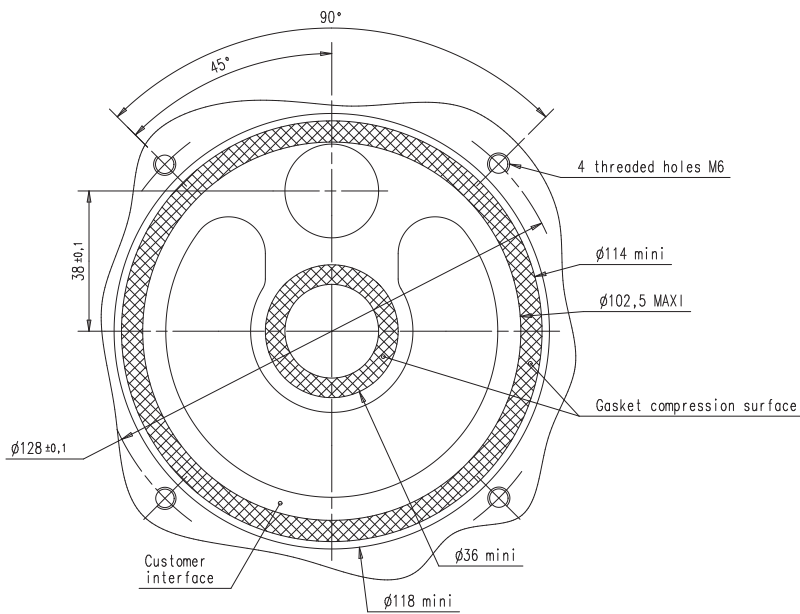

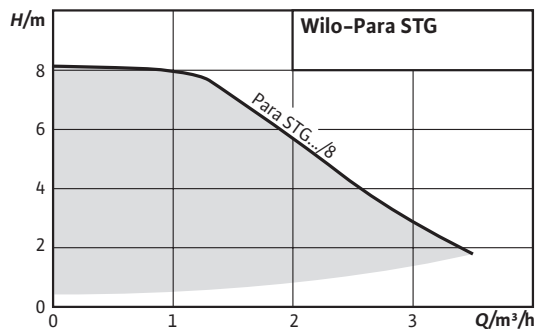

Wilo-Para STG



Design

Glandless circulation pump with a cast iron pump housing and corrosion-protected motor housing and screws. EC motor with automatic power adjustment and self-protecting modes. The one fits all solution which keeps your business running.

Application

Hot-water heating systems of all kinds, cooling applications

- One product for all applications
- Self-controlled pump (Operating button) or externally controlled (iPWM1 and iPWM2 signal)
- Operating button for convenient settings
- LED user interface
- Manual air-venting routine and re-start function
- Reset to factory settings

Type key

Example: **Para STG 15-30/8-75/SC**

Para Electronically controlled high-efficiency pump pump range adapted to requirements of the OEM market

Heating inline cast iron pump housing

STG Standard cast iron pump housing

15-130 Nominal diameter - Pump housing length

15 threading 1"

25 threading 1 1/2"

30 threading 2"

7-50 Nominal delivery head range [m] -

Power consumption

SC control:

SC = Self Controlled pump

or

PWM1 or **PWM2** = the pump is controlled by an external system via PWM1 or iPWM1 signal

12 Position of electronic module

Options

- External control via iPWM
- Control mode Δp -c (constant), Δp -v (variable), constant speed
- Control mode selection and differential pressure setpoint setting for Δp -c, Δp -v via operating button
- Delivery in collective (180 pumps/package)

Type Key Example:

Technical data	
Approved fluids (other fluids on request)	
Drinking water and water for food-processing companies in accordance with TrinkwV 2001 (drinking water ordinance)	-
Power	
Energy efficiency index (EEI)	≤ 0.21
Max. delivery head H_{max}	8.40 m
Max. volume flow Q_{max}	4.0 m ³ /h
Permitted field of application	
Temperature range at max. ambient temperature	of 58°C = 0 to 100°C of 62°C = 0 to 90°C of 66°C = 0 to 80°C of 71°C = 0 to 70°C
Maximum static pressure p	10 bar
• = appropriate, - = not appropriate	

Technical data	
Electrical connection	
Mains connection	1~230 V, 50/60 Hz
Motor/electronics	
Electromagnetic compatibility	EN 61800-3
Emitted interference	EN 61000-6-3 / EN 61000-6-4
Speed control	Frequency converter
Interference resistance	EN 61000-6-2 / EN 61000-6-1
Protection class	IP X4D
Insulation class	F
Minimum suction head at suction port for avoiding cavitation at water pumping temperature	
Minimum suction head at 50 / 95 °C	0.5 / 4.5 m
• = appropriate, - = not appropriate	

Motor data					
Para STG	Speed	EEI	Power consumption 1~230 V	Current at 1~230V	Motor protection
	n rpm		P_1 W	I A	
15-130/8-75	500 - 4800	≤ 0.21	2 - 75	0.03 - 0.66	integrated
25-130/8-75	500 - 4800	≤ 0.21	2 - 75	0.03 - 0.66	integrated
25-180/8-75	500 - 4800	≤ 0.21	2 - 75	0.03 - 0.66	integrated
30-180/8-75	500 - 4800	≤ 0.21	2 - 75	0.03 - 0.66	integrated

Pump curves

$\Delta p-v$ (variable)

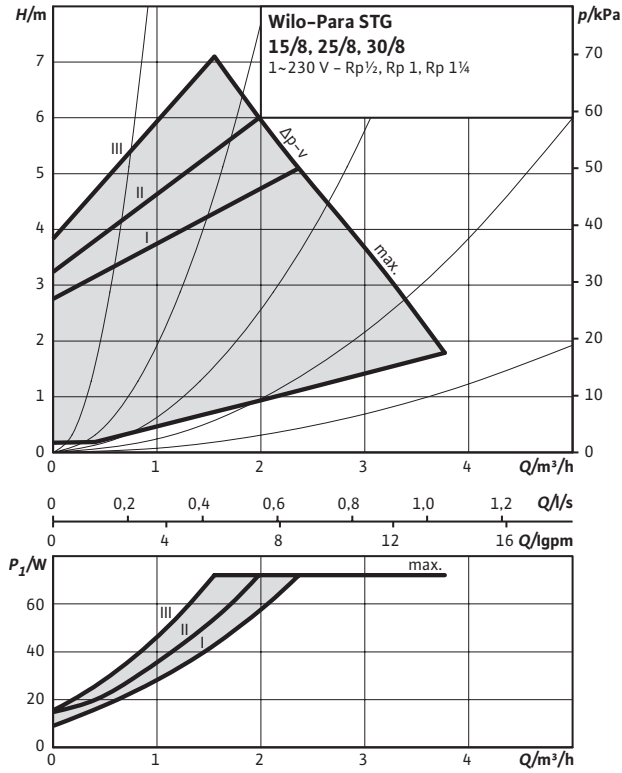

Pump curves

$\Delta p-c$ (constant)

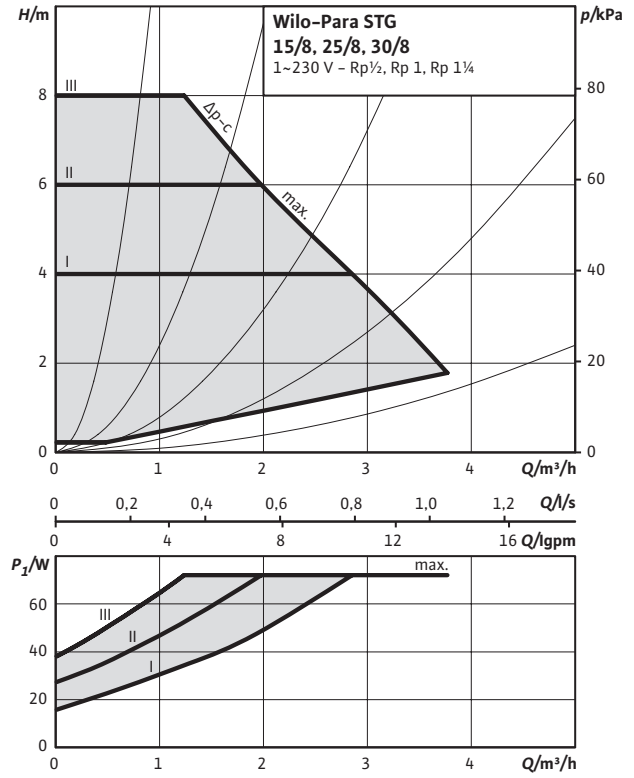

Pump curves

Constant speed I, II, III

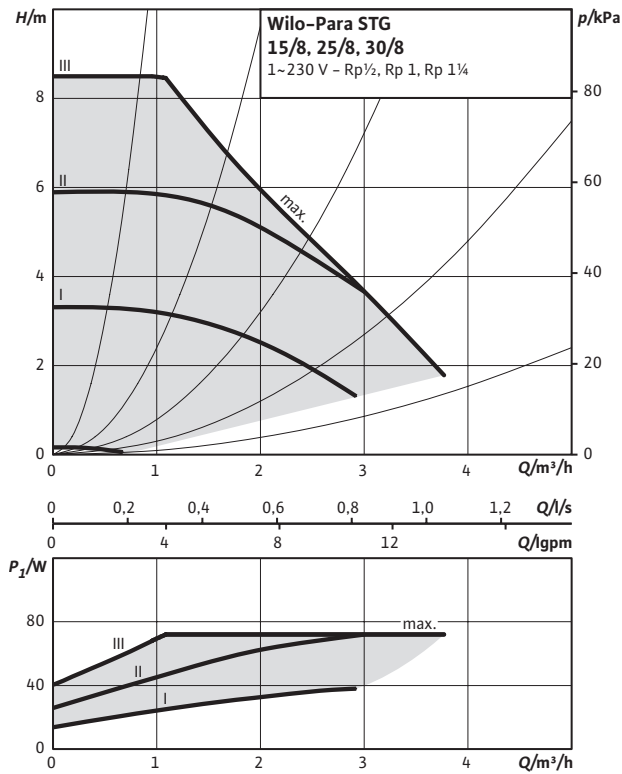

Pump curves

External control via PWM 1

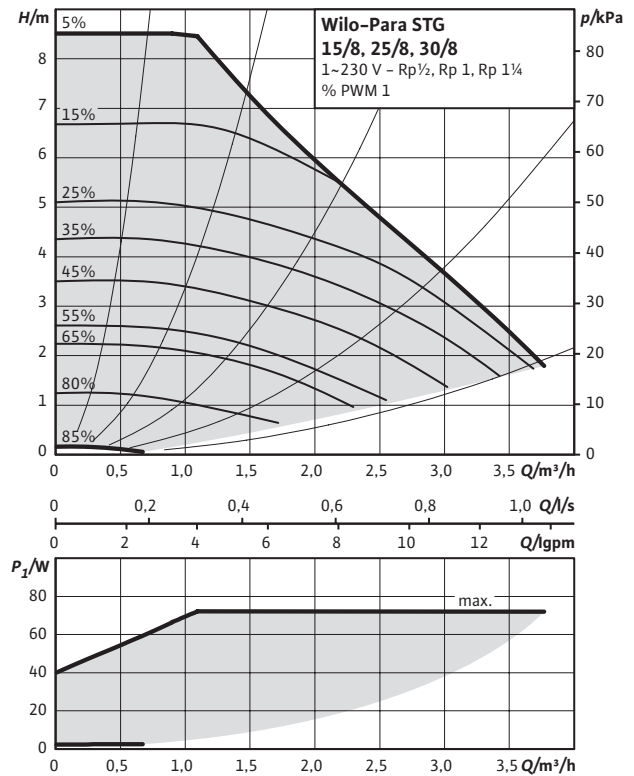

Dimension drawing

Wilo-Para STG

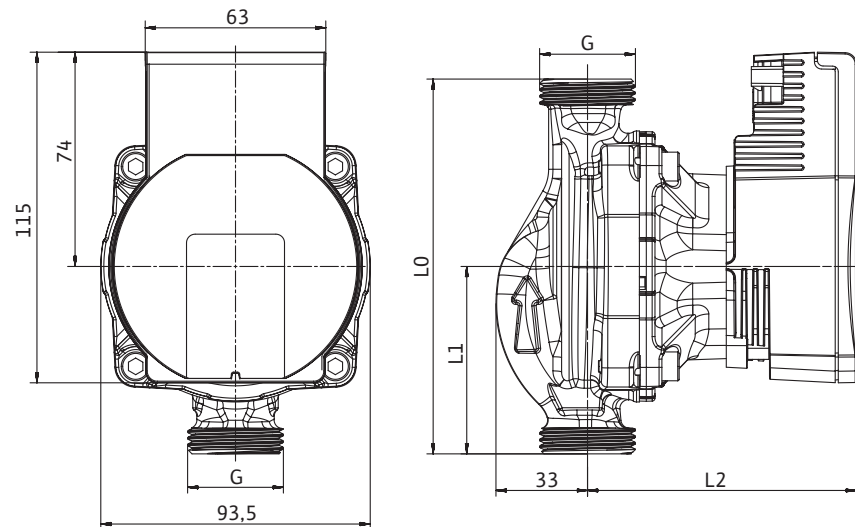

Technical data

Designation	Para STG 15-130/8-75	Para STG 25-130/8-75	Para STG 25-180/8-75	Para STG 30-180/8-75
Threaded pipe union	Rp 1/2		Rp 1	Rp 1/4
Thread	G 1		G 1 1/2	G 2
Overall length l_0		130 mm		180 mm
Dimensions $L1$		65 mm		90 mm
Dimensions $L2$			105 mm	
Weight approx. m	1.7 kg	1.8 kg	2 kg	2.1 kg

Materials

Pump housing	Cast iron with cathaphoresis treatment
Impeller	PP composite with GF 40%
Pump shaft	Stainless steel
Bearing	Carbon, metal impregnated



Wilo-Yonos PARA High Flow 25/7, 30/7



Design

Glandless circulation pump with cast iron pump housing and threaded connection. EC-motor with automatic power adjustment.

Application

Hot-water heating systems of all kinds, closed cooling circuits, industrial circulation systems, circulation in solar thermal and geothermal systems.

Type key

Example:	Wilo-Yonos PARA HF 25/7
Yonos	Electronically controlled high-efficiency pump
PARA	pump range adapted to requirements of the OEM market
HF	High Flow
25/	Nominal diameter: 25 threading 1 1/2" 30 threading 2"
7	Nominal delivery head range [m]

Technical data

Approved fluids (other fluids on request)

Heating water (in accordance with VDI 2035)	•
Water-glycol mixtures (max. 1:1; above 20% admixture, the pumping data must be checked)	•

Power

Energy efficiency index (EEI)	≤ 0.23
Max. delivery head H_{max}	7.00 m
Max. volume flow Q_{max}	7.0 m ³ /h

Permitted field of application

Temperature range at max. ambient temperature	of 25°C = -20 to 110°C
Maximum static pressure p	10 bar

Electrical connection

Mains connection	1~230 V, 50/60 Hz
------------------	-------------------

Motor/electronics

Electromagnetic compatibility	Conformity with EMC Directive 2004/108/EC
Emitted interference	EN 61000-6-3
Speed control	Frequency converter
Interference resistance	EN 61000-6-2
Protection class	IP X4D
Insulation class	F

Minimum suction head at suction port for avoiding cavitation at water pumping temperature

Minimum suction head at 50 / 95 / 110 °C	0.5 / 3 / 10 m
--	----------------

• = appropriate, - = not appropriate

Yonos PARA High Flow	Speed	Power consumption 1~230 V	Current at 1~230V	Motor protection
	n rpm	P_1 W	I A	
HF 25/7 PN10	1000 - 3700	5 - 120	0.08 - 1.00	integrated
HF 30/7 PN10	1000 - 3700	5 - 120	0.08 - 1.00	integrated

Pump curves

Dimension drawing 25/7, 30/7

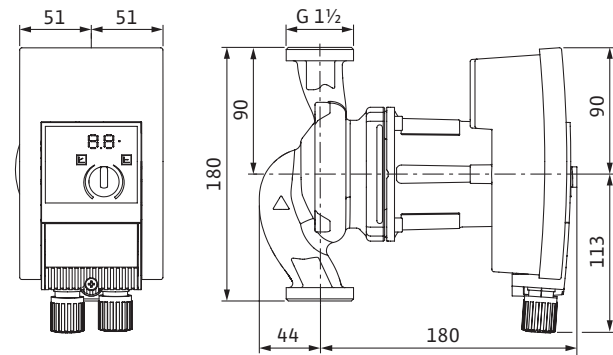
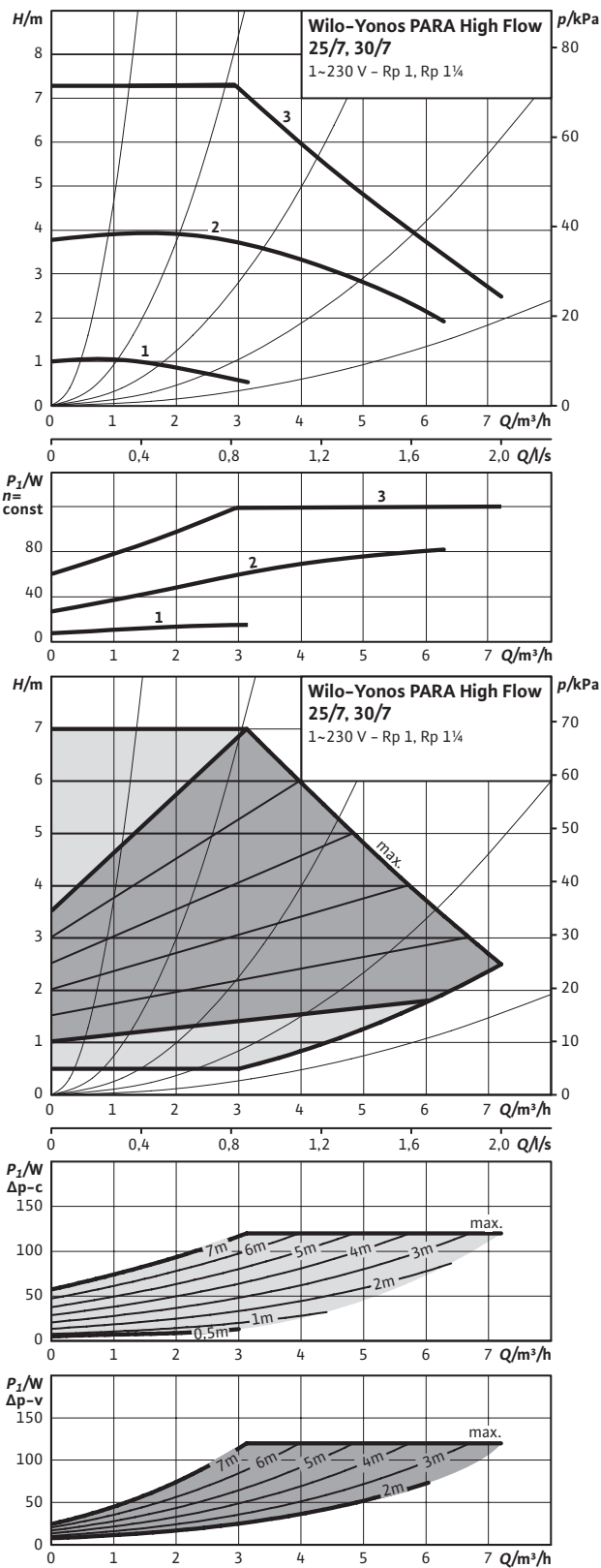

Technical data

Designation	Yonos PARA HF 25/7	Yonos PARA HF 30/7
Threaded pipe union	Rp 1	RP 1½
Thread G	G 1½	G 2
Overall length l_0	180 mm	
Weight approx. m	4.5 kg	4.6 kg
Dimensions $L1$	90 mm	

Materials

Pump housing	Grey cast iron (EN-GJL-200)
Impeller	Plastic (PPE - 30% GF)
Pump shaft	Stainless steel (X30CR13)
Bearing	Carbon, metal impregnated



Wilo-Yonos PARA High Flow 25/10, 30/10



Design

Glandless circulation pump with cast iron pump housing and threaded connection. EC-motor with automatic power adjustment.

Application

Hot-water heating systems of all kinds, closed cooling circuits, industrial circulation systems, circulation in solar thermal and geothermal systems.

Type key

- Example: **Wilo-Yonos PARA HF 25/10**
Yonos Electronically controlled high-efficiency pump
PARA pump range adapted to requirements of the OEM market
HF High Flow
25/ Nominal diameter:
25 threading 1 1/2"
30 threading 2"
10 Nominal delivery head range [m]

Technical data

Approved fluids (other fluids on request)

Heating water (in accordance with VDI 2035)	•
Water-glycol mixtures (max. 1:1; above 20% admixture, the pumping data must be checked)	•

Power

Energy efficiency index (EEI)	≤ 0.23
Max. delivery head H_{max}	10.00 m
Max. volume flow Q_{max}	8.5 m ³ /h

Permitted field of application

Temperature range at max. ambient temperature	of 25°C = -20 to 110°C
Maximum static pressure p	10 bar

Electrical connection

Mains connection	1~230 V, 50/60 Hz
------------------	-------------------

Motor/electronics

Electromagnetic compatibility	Conformity with EMC Directive 2004/108/EC
Emitted interference	EN 61000-6-3
Speed control	Frequency converter
Interference resistance	EN 61000-6-2
Protection class	IP X4D
Insulation class	F

Minimum suction head at suction port for avoiding cavitation at water pumping temperature

Minimum suction head at 50 / 95 / 110 °C	0.5 / 3 / 10 m
--	----------------

• = appropriate, - = not appropriate

Yonos PARA High Flow	Speed	Power consumption 1~230 V	Current at 1~230V	Motor protection
	n rpm	P_1 W	I A	
HF 25/10	1000 - 4400	5 - 190	0.08 - 1.30	integrated
HF 30/10	1000 - 4400	5 - 190	0.08 - 1.30	integrated

Pump curves

Dimension drawing 25/7, 30/7

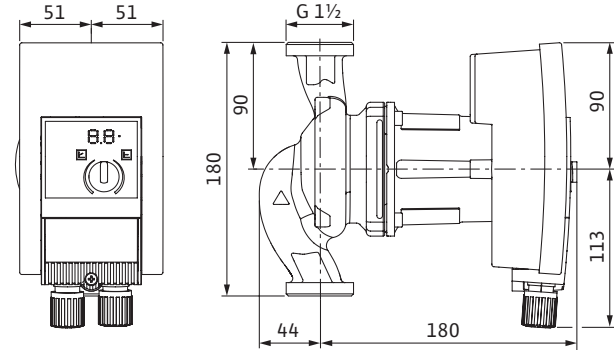
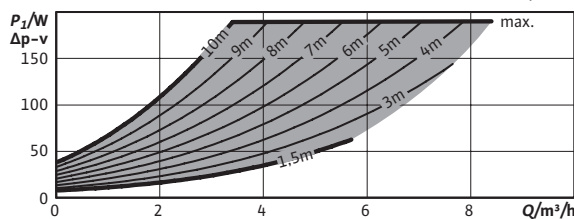
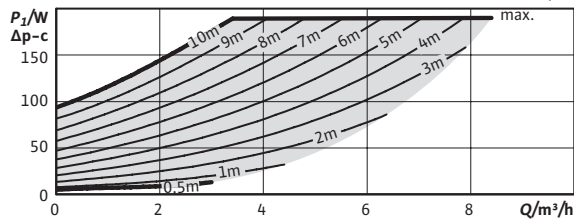
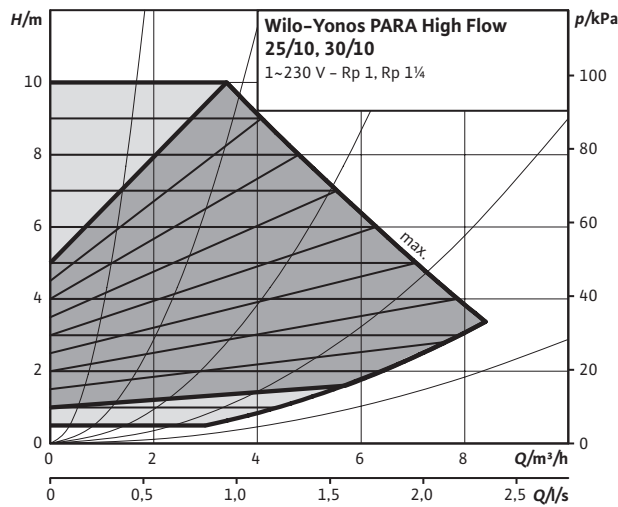
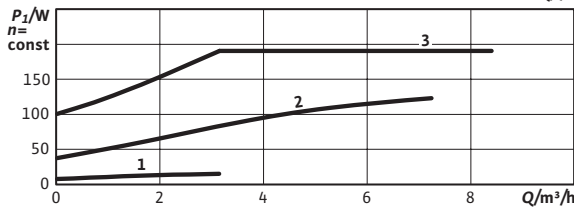
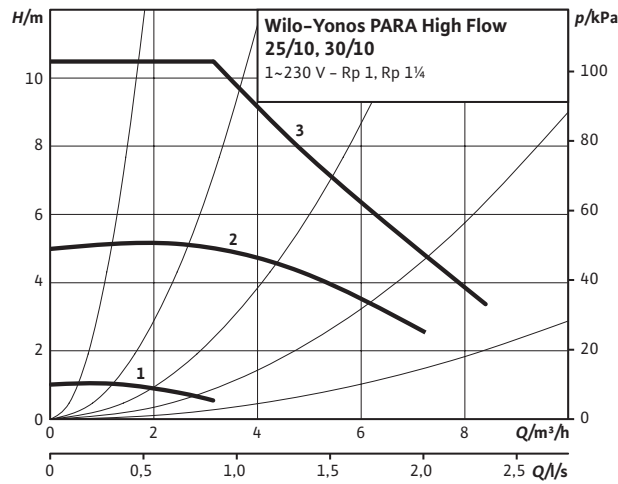

Technical data

Designation	Yonos PARA HF 25/10	Yonos PARA HF 30/10
Threaded pipe union	Rp 1	Rp 1¼
Thread	G 1½	G 2
Overall length l_0	180 mm	
Weight approx. m	4.5 kg	4.6 kg
Dimensions $L1$	90 mm	

Materials

Pump housing	Grey cast iron (EN-GJL-200)
Impeller	Plastic (PPE - 30% GF)
Pump shaft	Stainless steel (X30CR13)
Bearing	Carbon, metal impregnated



Wilo-Yonos PARA High Flow 25/12, 30/12



Design

Glandless circulation pump with cast iron pump housing and threaded connection. EC-motor with automatic power adjustment.

Application

Hot-water heating systems of all kinds, closed cooling circuits, industrial circulation systems, circulation in solar thermal and geothermal systems.

Type key

- Example: **Wilo-Yonos PARA HF 25/12**
Yonos Electronically controlled high-efficiency pump
PARA pump range adapted to requirements of the OEM market
HF High Flow
25/ Nominal diameter:
25 threading 1 1/2"
30 threading 2"
12 Nominal delivery head range [m]

Technical data

Approved fluids (other fluids on request)

Heating water (in accordance with VDI 2035) •

Water-glycol mixtures (max. 1:1; above 20% admixture, the pumping data must be checked) •

Power

Energy efficiency index (EEI) ≤ 0.23

Max. delivery head H_{max} 11.00 m

Max. volume flow Q_{max} 11.0 m³/h

Permitted field of application

Temperature range at max. ambient temperature of 25 °C = -20 to 110 °C

Maximum static pressure p 10 bar

Electrical connection

Mains connection 1~230 V, 50/60 Hz

Motor/electronics

Electromagnetic compatibility Conformity with EMC Directive 2004/108/EC

Emitted interference EN 61000-6-3

Speed control Frequency converter

Interference resistance EN 61000-6-2

Protection class IP X4D

Insulation class F

Minimum suction head at suction port for avoiding cavitation at water pumping temperature

Minimum suction head at 50 / 95 / 110 °C 0.5 / 3 / 10 m

• = appropriate, - = not appropriate

Yonos PARA High Flow	Speed	Power consumption 1~230 V	Current at 1~230V	Motor protection
	n rpm	P_1 W	I A	
HF 25/12	1000 - 4800	10 - 305	0.15 - 1.33	integrated
HF 30/12	1000 - 4800	10 - 305	0.15 - 1.33	integrated

Pump curves

Dimension drawing 25/7, 30/7

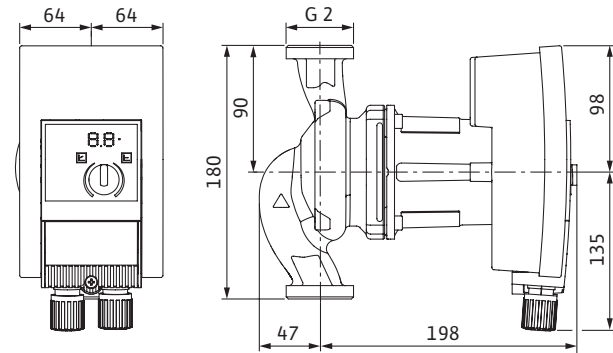
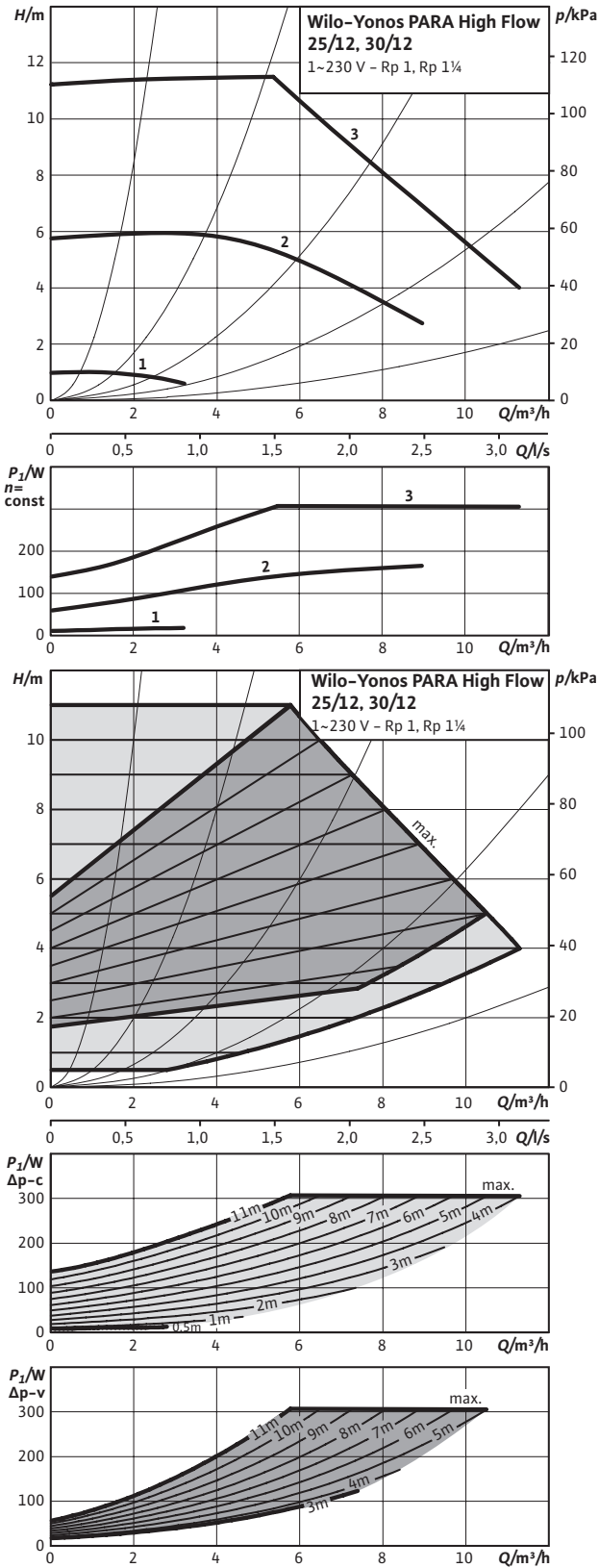

Technical data

Designation	Yonos PARA HF 25/12	Yonos PARA HF 30/12
Threaded pipe union	Rp 1	Rp 1½
Thread	G 1½	G 2
Overall length l_0	180 mm	
Weight approx. m	5.3 kg	5.4 kg
Dimensions $L1$	90 mm	

Materials

Pump housing	Grey cast iron (EN-GJL-200)
Impeller	Plastic (PPE - 30% GF)
Pump shaft	Stainless steel (X30CR13)
Bearing	Carbon, metal impregnated



Wilo-Stratos PARA 25/1-8, 30/1-8



Design

Glandless circulator with screwed connection.
EC motor with automatic power adjustment.
Supplied as standard with cable for easy electrical connection.

Application

Hot-water heating systems of all kinds, air-conditioning systems, closed cooling circuits, industrial circulation systems, circulation in solar thermal technology and geothermal systems.

Type key

Example:	Wilo-Stratos PARA 25/1-8 T1
Stratos	High-efficiency pump, electronically controlled
PARA	series adapted to the OEM market requirements
25/	Nominal connection diameter
1-8	Nominal delivery head range [m]
T1	Type key for combinations of the function and equipment range
12 h	Position of the electronic module, special version
(N/A)	Position of the electronic module, 6 h, standard version

Options

- External control via 0 – 10 V or PWM
- Control mode Δp -c (constant), Δp -v (variable)
- Control mode selection and differential pressure setpoint adjustment at Δp -c, Δp -v via the operating button

- Energy efficiency class A
- Maximum efficiency thanks to ECM technology
- Up to 80 % electricity savings compared to uncontrolled circulators
- High starting torque for safe start
- For all heating, air-conditioning and cooling systems within a temperature range of $-10\text{ }^{\circ}\text{C}$ to $+95\text{ }^{\circ}\text{C}$
- Prevention of flow noise
- Safety and comfort during installation and operation
- Scope of functions especially adapted to the OEM market requirements and space-saving design. Optimum performance even in cramped installation locations.
- Supplied as standard with cable for easy electrical connection
- Convenient adjustment of the pump via the external control signals or the operating button
- Pump housing with cataphoretic coating (KTL) to prevent corrosion due to condensation water

- Special version without operating button
- All possible combinations of functions and equipment are available (see page 25)
- Version with cable in accordance with customer specification
- Version with short port-to-port length 130 mm

- Supplied in combined packaging (196 pumps/package)
- Supplied with thermal insulation
- Cold water insulation shell as an accessory
- Version for application at 110 °C, 10 bar (ambient temperature max. 40 °C) on request

Type Key Example:

Technical data	
Approved fluids (other fluids on request)	
Heating water (in accordance with VDI 2035)	•
Water-glycol mixtures (max. 1:1; above 20% admixture, the pumping data must be checked)	•
Power	
Energy efficiency index (EEI)	≤ 0.23
Max. delivery head H_{max}	8.00 m
Max. volume flow Q_{max}	8.0 m ³ /h
Permitted field of application	
Temperature range at max. ambient temperature	Of 25°C = -10 to 110°C Of 40°C = -10 to 90°C Of 45°C = -10 to 80°C Of 50°C = -10 to 70°C Of 55°C = -10 to 60°C Of 60°C = -10 to 50°C Of 65°C = -10 to 40°C
Maximum static pressure p	10 bar
• = appropriate, - = not appropriate	

Technical data	
Electrical connection	
Mains connection	1~230 V, 50/60 Hz
Motor/electronics	
Electromagnetic compatibility	-
Emitted interference	EN 61800-3;2004+A1;2012 /residential area (C1)
Speed control	Frequency converter
Interference resistance	EN 61800-3;2004+A1;2012 /industrial environment (C2)
Protection class	IP X4D
Insulation class	F
Minimum suction head at suction port for avoiding cavitation at water pumping temperature	
Minimum suction head at 50 / 95 / 110 °C	3 / 10 / 16 m
• = appropriate, - = not appropriate	

Stratos PARA	Speed	Power consumption 1~230 V	Current at 1~230V	Motor protection
	n rpm	P_1 W	I A	
25/1-8	1400 - 3900	8 - 130	0.07 - 0.95	integrated
30/1-8	1400 - 3900	8 - 130	0.07 - 0.95	integrated

Heating and cooling systems

Pump curves

Δp -c (constant)

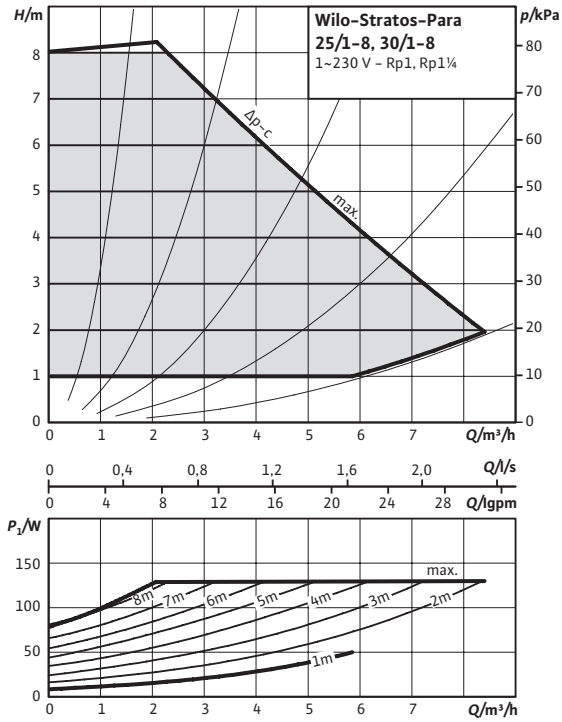

Pump curves

Δp -v (variable)

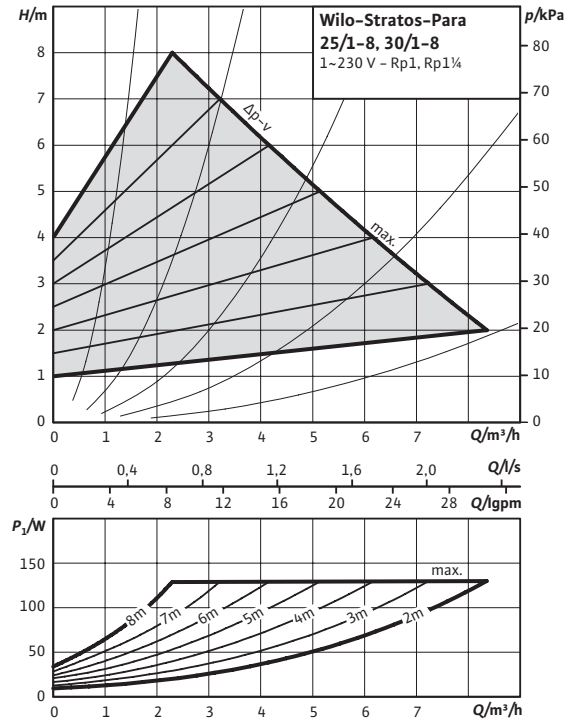

Pump curves

External control mode via Analog-In 0-10 V

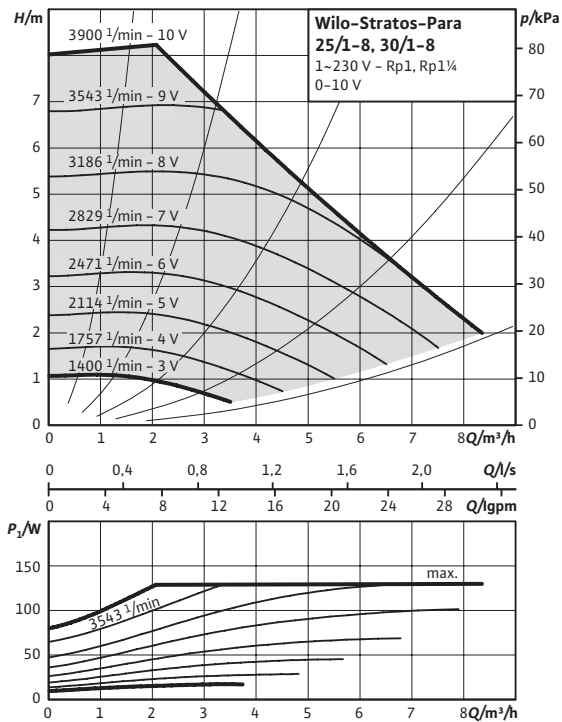

Pump curves

External control via PWM

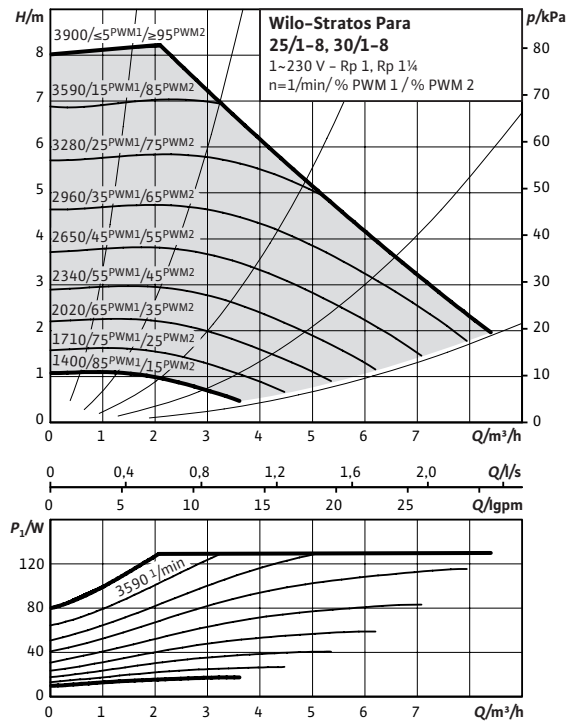

Dimension drawing

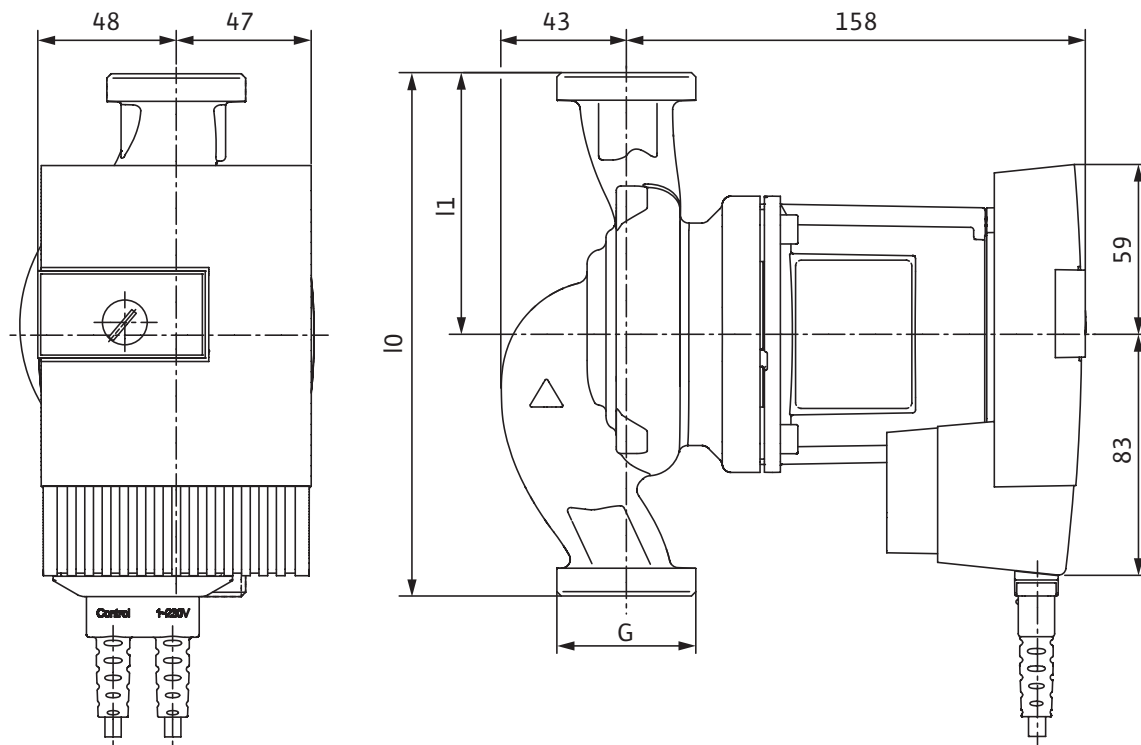

Technical data

Designation	Stratos PARA 25/1-8	Stratos PARA 25/1-8	Stratos PARA 30/1-8
Threaded pipe union		Rp 1	Rp 1¼
Thread		G 1½	G 2
Overall length l_o	130 mm	180 mm	180 mm
Weight approx. m		4.7 kg	
Dimensions $L1$	65 mm	90 mm	90 mm
Materials			
Pump housing		Grey cast iron (EN-GJL-200)	
Impeller		Plastic (PPS - 40% GF)	
Pump shaft		Stainless steel (X30CR13)	
Bearing		Carbon, metal impregnated	



Wilo-Stratos PARA 25/1-11, 30/1-11

Design

Glandless circulator with screwed connection.
EC motor with automatic power adjustment.
Supplied as standard with cable for easy electrical connection.

Application

Hot-water heating systems of all kinds, air-conditioning systems, closed cooling circuits, industrial circulation systems, circulation in solar thermal technology and geothermal systems.

Type key

Example:	Wilo-Stratos PARA 25/1-11 T1
Stratos	Electronically controlled high-efficiency pump
PARA	Pump range adapted to requirements of the OEM market
25/	Nominal connection diameter
1-11	Nominal delivery head range [m]
T1	Type key for combinations of function and equipment
12 h	Position of electronic module, special version
(not specified)	Position of electronic module 6h, standard version

Options

- External control via 0-10V or PWM
- Control mode Δp -c (constant), Δp -v (variable)
- Control mode selection and differential pressure setpoint setting for Δp -c, Δp -v via operating button
- Special version without operating button

- Energy efficiency class A
- Maximum efficiency thanks to ECM technology
- Up to 80% electricity savings compared to uncontrolled circulation pumps
- High starting torque for reliable starting
- For all heating and cooling systems in the temperature range of -10 °C to $+110\text{ °C}$
- Prevention of flow noise
- Safety and comfort during installation and operation
- Functions and space-saving design were specially adapted to the requirements of the OEM market. Optimum output even in narrow installation situations.
- Standard delivery with cable for an easy electrical connection
- Convenient setting of the pump via external control signals or the operating button
- Cast iron pump housing with cataphoretic (KTL) coating for the prevention of corrosion from condensation formation

- All possible combinations of functions and equipment are available (see page 25)
- Version with cable according to customer specification
- Version with short overall length of 130 mm
- Delivery in collective packaging (108 pumps/packaging)
- Delivery with thermal insulation
- Cold insulation Cooling-Shell as accessories

Type Key Example:

Technical data	
Approved fluids (other fluids on request)	
Heating water (in accordance with VDI 2035)	•
Water-glycol mixtures (max. 1:1; above 20% admixture, the pumping data must be checked)	•
Power	
Energy efficiency index (EEI)	≤ 0.23
Max. delivery head H_{max}	11.00 m
Max. volume flow Q_{max}	4.5 m ³ /h
Permitted field of application	
Temperature range at max. ambient temperature	Of 25°C = -10 to 110°C Of 40°C = -10 to 90°C Of 45°C = -10 to 80°C Of 50°C = -10 to 70°C Of 55°C = -10 to 60°C Of 60°C = -10 to 50°C
Maximum static pressure p	10 bar
• = appropriate, - = not appropriate	

Technical data	
Electrical connection	
Mains connection	1~230 V, 50/60 Hz
Motor/electronics	
Electromagnetic compatibility	-
Emitted interference	EN 61800-3;2004+A1;2012 /residential area (C1)
Speed control	Frequency converter
Interference resistance	EN 61800-3;2004+A1;2012 /industrial environment (C2)
Protection class	IP X4D
Insulation class	F
Minimum suction head at suction port for avoiding cavitation at water pumping temperature	
Minimum suction head at 50 / 95 / 110 °C	3 / 10 / 16 m
• = appropriate, - = not appropriate	

Stratos PARA	Speed	Power consumption 1~230 V	Current at 1~230V	Motor protection
	n rpm	P_1 W	I A	
25/1-11	1400 - 4850	8 - 140	0.07 - 1.05	integrated
30/1-11	1400 - 4850	8 - 140	0.07 - 1.05	integrated

Pump curves

Δp -c (constant)

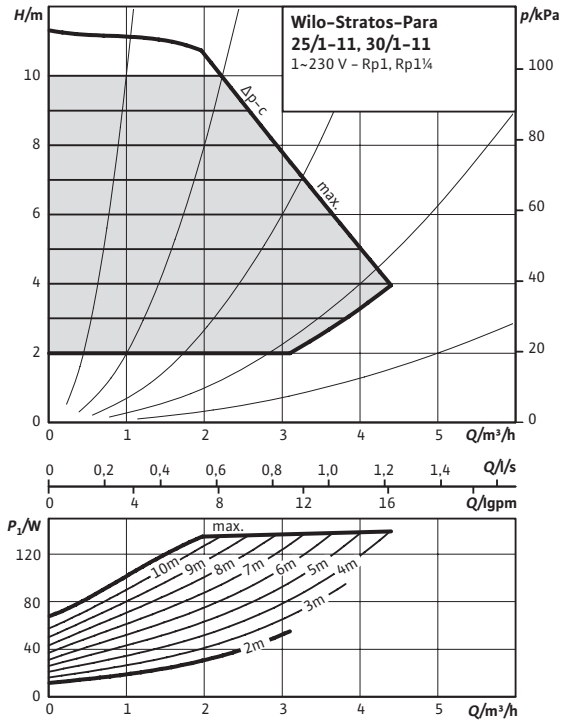

Pump curves

Δp -v (variable)

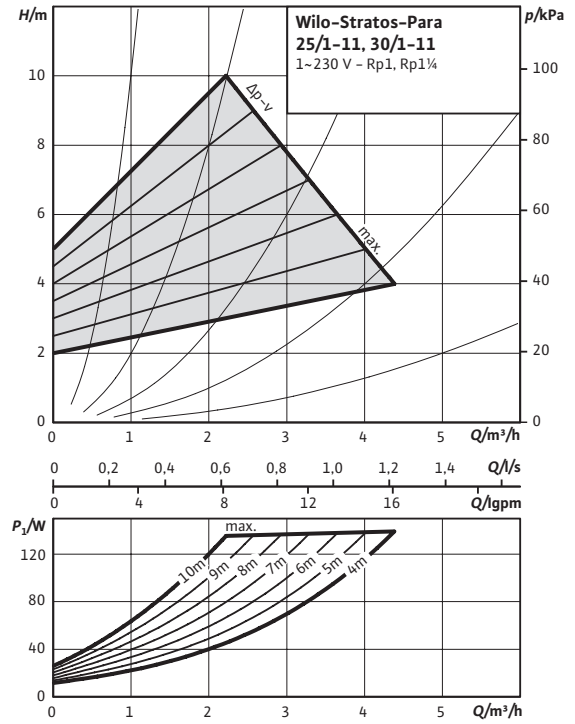

Pump curves

External control mode via Analog-In 0-10 V

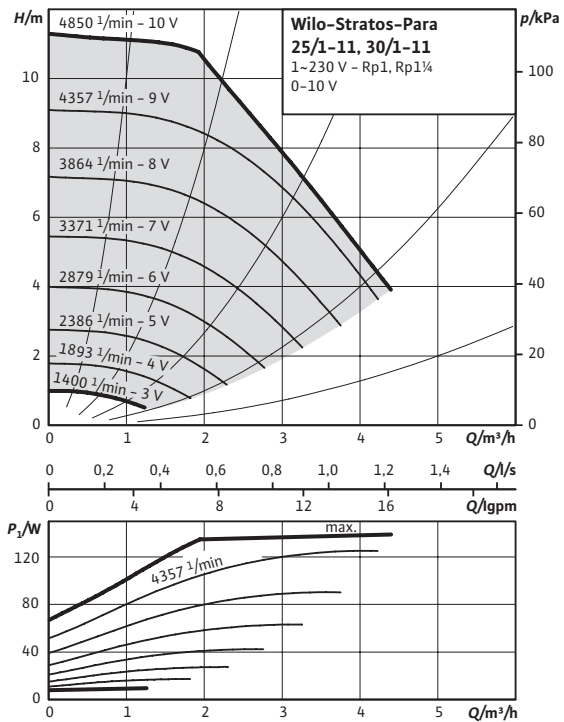

Pump curves

External control via PWM

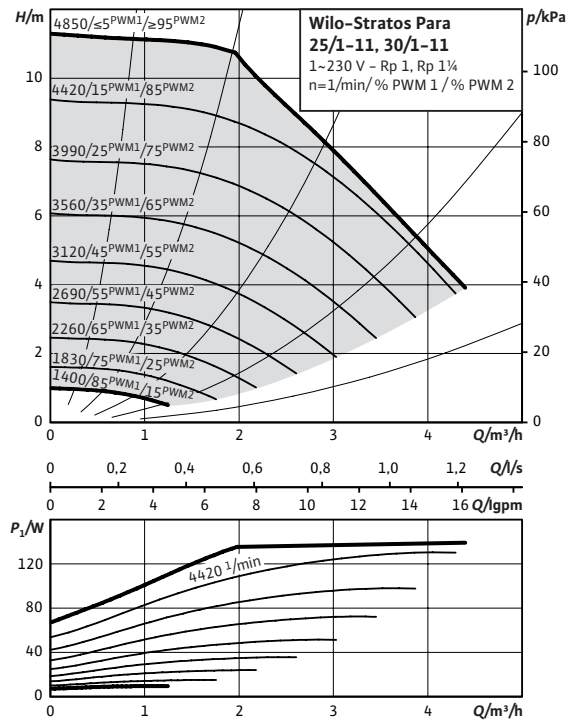

Dimension drawing

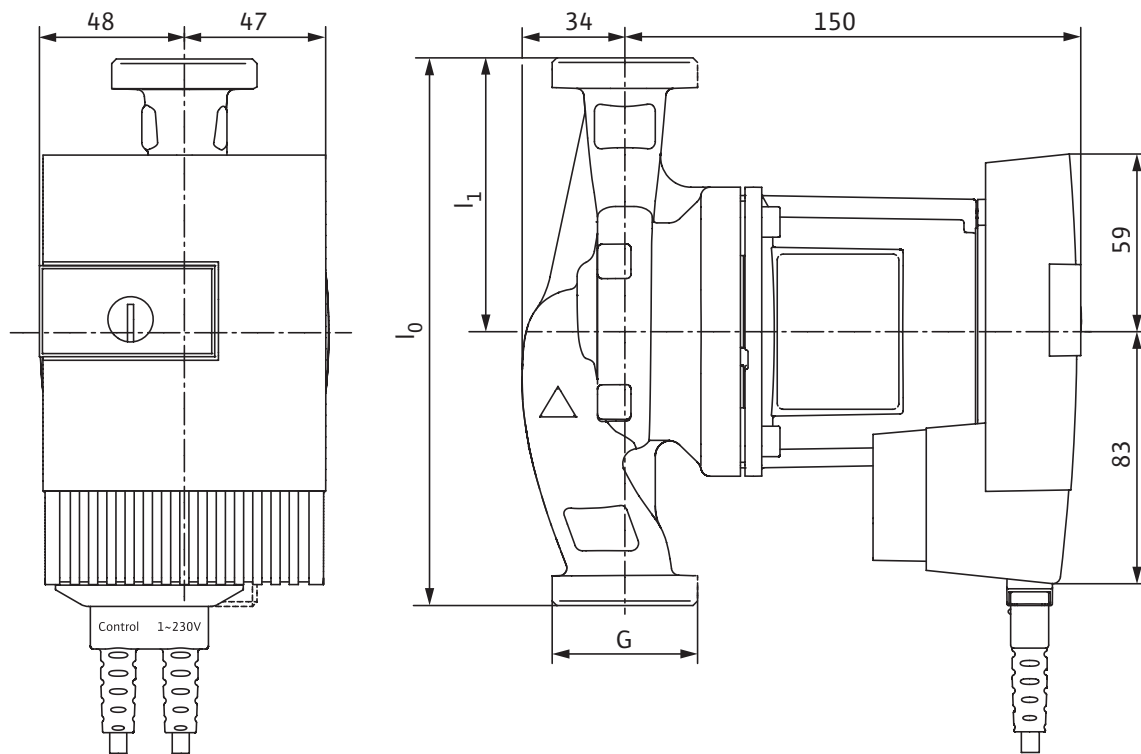

Technical data

Designation	Stratos PARA 25/1-11	Stratos PARA 25/1-11	Stratos PARA 30/1-11
Threaded pipe union		Rp 1	Rp 1¼
Thread		G 1½	G 2
Overall length l_0	130 mm	180 mm	180 mm
Weight approx. m		4.3 kg	
Dimensions $L1$	65 mm	90 mm	90 mm
Materials			
Pump housing	Grey cast iron (EN-GJL-200)		
Impeller	Plastic (PPE - 30% GF)		
Pump shaft	Stainless steel (X30CR13)		
Bearing	Carbon, metal impregnated		



Wilo-Stratos PARA 25/1-12, 30/1-12

Design

Glandless circulator with screwed connection.
EC motor with automatic power adjustment.
Supplied as standard with cable for easy electrical connection.

Application

Hot-water heating systems of all kinds, air-conditioning systems, closed cooling circuits, industrial circulation systems, circulation in solar thermal technology and geothermal systems.

Options

- External control via 0-10V or PWM
- Control mode $\Delta p-c$ (constant), $\Delta p-v$ (variable)
- Control mode selection and differential pressure setpoint setting for $\Delta p-c$, $\Delta p-v$ via operating button
- Special version without operating button
- All possible combinations of functions and equipment are available (see page 25)
- Version with cable according to customer specification
- Delivery in collective packaging (72 pumps/package)
- Delivery with thermal insulation
- Cold insulation Cooling-Shell as accessories

- Energy efficiency class A
- Maximum efficiency thanks to ECM technology
- Up to 80% electricity savings compared to uncontrolled circulation pumps
- High starting torque for reliable starting
- For all heating and cooling systems in the temperature range of -10 °C to $+110\text{ °C}$
- Prevention of flow noise
- Safety and comfort during installation and operation
- Functions and space-saving design were specially adapted to the requirements of the OEM market. Optimum output even in narrow installation situations.
- Standard delivery with cable for an easy electrical connection
- Convenient setting of the pump via external control signals or the operating button
- Cast iron pump housing with cathophoretic (KTL) coating for the prevention of corrosion from condensation formation

Type key

Example: **Wilco-Stratos PARA 25/1-12 T1**

Stratos Electronically controlled high-efficiency pump

PARA Pump range adapted to requirements of the OEM market

25/ Nominal connection diameter

1-12 Nominal delivery head range [m]

T1 Type key for combinations of function and equipment

12 h Position of electronic module, special version

(not specified) Position of electronic module 6h, standard version

Type Key Example:

Technical data	
Approved fluids (other fluids on request)	
Heating water (in accordance with VDI 2035)	•
Water-glycol mixtures (max. 1:1; above 20% admixture, the pumping data must be checked)	•
Power	
Energy efficiency index (EEI)	≤ 0.23
Max. delivery head H_{max}	12.00 m
Max. volume flow Q_{max}	10.0 m ³ /h
Permitted field of application	
Temperature range at max. ambient temperature	of 25°C = -10 to 110°C Of 40°C = -10 to 90°C Of 45°C = -10 to 80°C Of 50°C = -10 to 65°C Of 55°C = -10 to 50°C Of 60°C = -10 to 35°C Of 65°C = -10 to 20°C
Maximum static pressure p	10 bar
• = appropriate, - = not appropriate	

Technical data	
Electrical connection	
Mains connection	1~230 V, 50/60 Hz
Motor/electronics	
Electromagnetic compatibility	-
Emitted interference	EN 61800-3;2004+A1;2012 / residential area (C1)
Speed control	Frequency converter
Interference resistance	EN 61800-3;2004+A1;2012 / industrial environment (C2)
Protection class	IP X4D
Insulation class	F
Minimum suction head at suction port for avoiding cavitation at water pumping temperature	
Minimum suction head at 50 / 95 / 110 °C	3 / 10 / 16 m
• = appropriate, - = not appropriate	

Stratos PARA	Speed	Power consumption 1~230 V	Current at 1~230V	Motor protection
	n rpm	P_1 W	I A	
25/1-12	1400 - 4800	16 - 310	0.16 - 1.37	integrated
30/1-12	1400 - 4800	16 - 310	0.16 - 1.37	integrated

Pump curves

$\Delta p-c$ (constant)

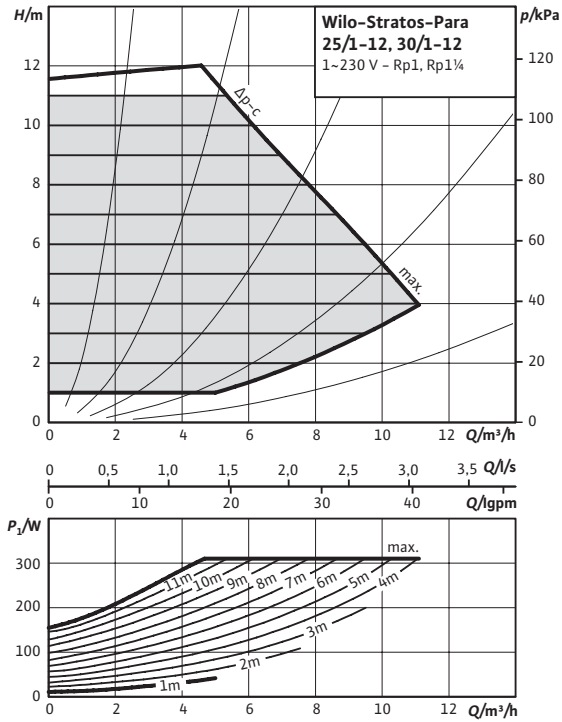

Pump curves

$\Delta p-v$ (variable)

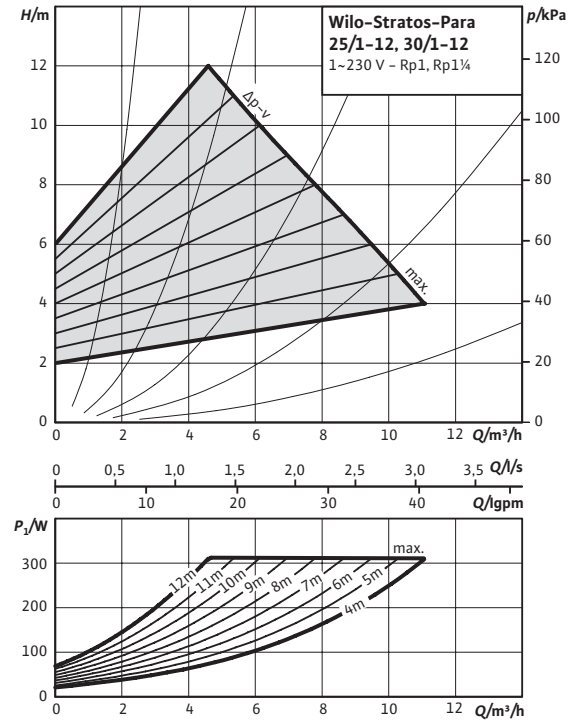

Pump curves

External control mode via Analog-In 0-10 V

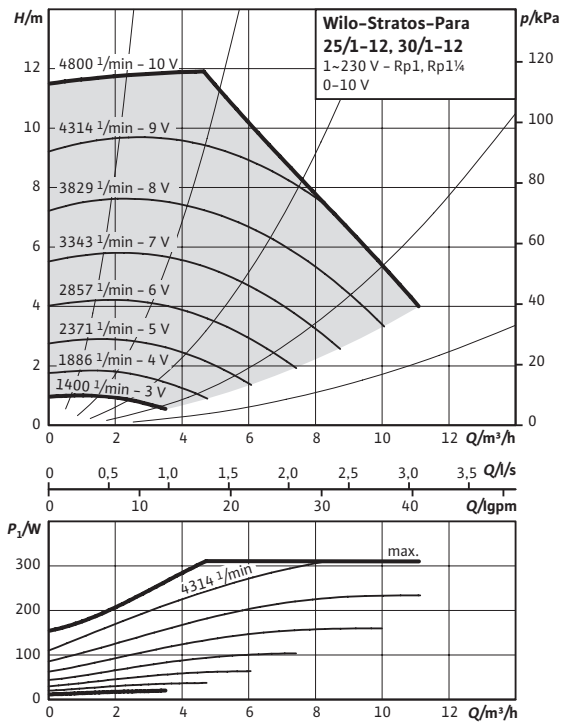

Pump curves

External control via PWM

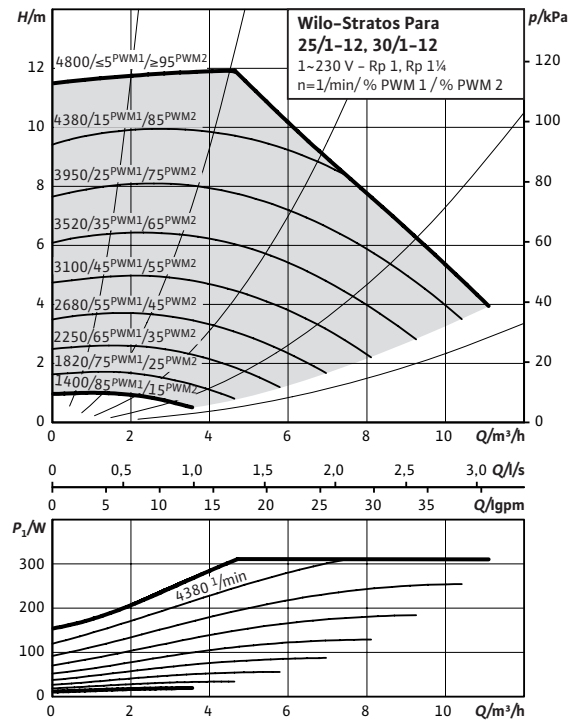

Dimension drawing

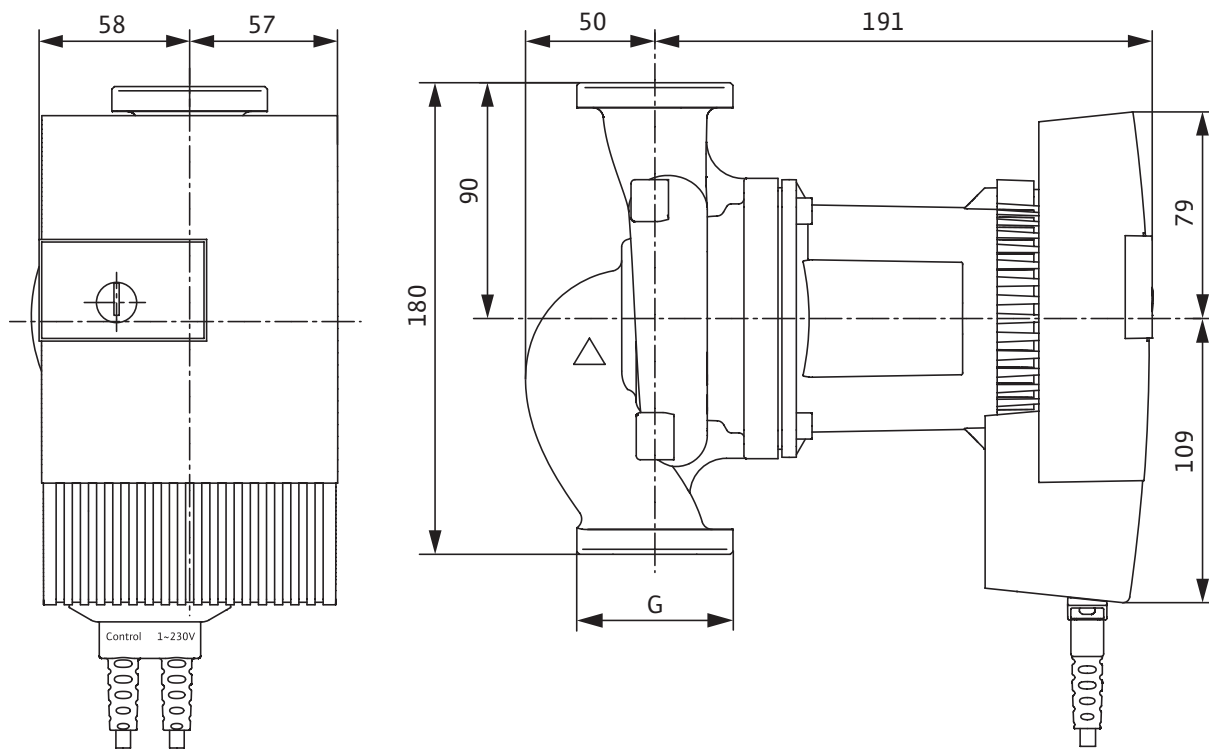

Technical data

Designation	Stratos PARA 25/1-12	Stratos PARA 30/1-12
Threaded pipe union	Rp 1	Rp 1¼
Thread	G 1½	G 2
Overall length l_o		180 mm
Weight approx. m		6.2 kg
Dimensions $L1$		90 mm
Materials		
Pump housing	Grey cast iron (EN-GJL-200)	
Impeller	Plastic (PPS - 40% GF)	
Pump shaft	Stainless steel (X39CrMo17-1)	
Bearing	Carbon, metal impregnated	



Solar thermal energy systems





Wilo-Para ST



Glandless circulation pump with a cast iron pump housing and threaded connection. EC-motor with automatic power adjustment and self-protecting modes. Mechanical design dedicated for solar thermal applications.

- Self-controlled pump (operating button) or externally controlled (iPWM2 or LIN Bus)
- Unique LED user interface
- Self-protecting modes
- Designed for optimised integration

Type
Wilo-Para ST

Page
124



Wilo-Para STG



Glandless circulation pump with a cast iron pump housing and corrosion-protected motor housing and screws. EC motor with automatic power adjustment and self-protecting modes. The one fits all solution which keeps your business running!

- One product for all applications
- Self-controlled pump (operating button) or externally controlled (iPWM1 and iPWM2 signal)
- Operating button for convenient settings
- LED user interface
- Manual air-venting routine and re-start function
- Reset to factory settings

Type
Wilo-Para STG

Page
98



Wilo-Stratos PARA



Glandless circulator with screwed connection. EC motor with automatic power adjustment. Supplied as standard with cable for easy electrical connection.

- External control via 0 – 10 V or PWM
- Control mode Δp -c (constant), Δp -v (variable)
- Control mode selection and differential pressure setpoint adjustment at Δp -c, Δp -v via the operating button
- Special version without operating button
- Further combinations of the range of equipment and functions are available: T1-19; T26, T27 (see page 27)
- Version with cable in accordance with customer specification
- Version with short port-to-port length 130 mm

Type
Wilo-Stratos PARA 25/1-8 T1

Page
108



Wilo-Yonos PARA High Flow



Glandless circulation pump with cast iron pump housing and threaded connection. EC-motor with automatic power adjustment.

- Control mode Δp -c (constant), Δp -v (variable), constant speed

Type
Wilo-Yonos PARA HF 25/7

Page
102

Technical data						
Type	Para ST 15/6 SC Para ST 25/6 SC Para ST 30/6 SC	Para ST 15/7 SC Para ST 25/7 SC Para ST 30/7 SC	Para ST 15/8 SC Para ST 25/8 SC Para ST 30/8 SC	Para ST 15/6* Para ST 25/6* Para ST 30/6*	Para ST 15/7* Para ST 25/7* Para ST 30/7*	Para ST 15/8* Para ST 25/8* Para ST 30/8*
Operating modes						
Manual control mode (n=constant)	Operating button	Operating button	Operating button	via PWM/LIN	via PWM/LIN	via PWM/LIN
Δp-c for constant differential pressure	✓	✓	✓	-	-	-
Δp-v for variable differential pressure	✓	✓	✓	-	-	-
Manual functions						
Operating mode setting	✓	✓	✓	-	-	-
Differential-pressure setpoint setting	✓	✓	✓	-	-	-
Automatic functions						
Infinitely variable power adjustment depending on the operating mode	-	-	-	✓	✓	✓
Deblocking function	✓	✓	✓	✓	✓	✓
Soft start	✓	✓	✓	✓	✓	✓
Full motor protection with integrated trip electronics	✓	✓	✓	✓	✓	✓
Venting routine	✓	✓	✓	-	-	-
External control functions						
Control input "Analog In 0 ... 10 V" with cable break function (remote speed adjustment)	-	-	-	-	-	-
Control input "Analog In 0 ... 10 V" without cable break function (remote setpoint adjustment)	-	-	-	-	-	-
Control input PWM	-	-	-	✓	✓	✓
Signal and display functions						
Collective run signal	-	-	-	-	-	-
Equipment/scope of delivery						
Operating button	✓	✓	-	-	-	-
Version without operating button (=external control)	-	-	-	✓	✓	✓
Wrench attachment point on pump body	✓	✓	-	✓	✓	✓
Including power cable	on request	on request	-	on request	on request	on request
Including power plug	✓	✓	-	✓	✓	✓
Including control cable	-	-	-	on request	on request	on request
Including seals for threaded connection (loose)	on request	on request	-	on request	on request	on request
Including installation and operating instructions	on request	on request	-	on request	on request	on request
Including thermal insulation	on request	on request	-	on request	on request	on request
Incl. Cooling-Shell	on request	on request	-	on request	on request	on request
Individual packaging	on request	on request	-	on request	on request	on request
Collective packaging	✓	✓	-	✓	✓	✓
✓ = equipped with - = not equipped with						
*iPWM2 or LIN						

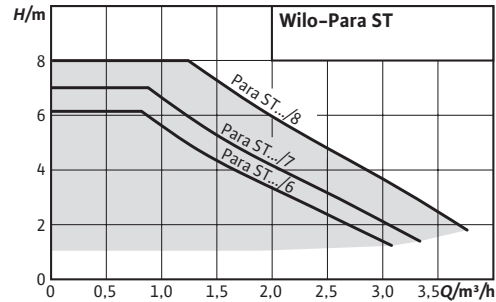

Wilo-Para ST



Design

Glandless circulation pump with a cast iron pump housing and threaded connection. EC-motor with automatic power adjustment and self-protecting modes. Mechanical design dedicated for solar thermal applications.

Application

Hot-water heating systems of all kinds, cooling applications

Type key

Example: **Para ST 15-30/7-50/SC**

Para Electronically controlled high-efficiency pump pump range adapted to requirements of the OEM market

Heating inline cast iron pump housing

ST Standard cast iron pump housing

15-130 Nominal diameter - Pump housing length

15 threading 1"

25 threading 1 1/2"

30 threading 2"

7-50 Nominal delivery head range [m] - Power consumption

SC control:

SC = Self Controlled pump

or

iPWM2 = the pump is controlled by an external system via PWM2 or iPWM2 signal

LIN = the pump is controlled by an external system via Lin Bus Communication

12 Position of electronic module

- Self-controlled pump (operating button) or externally controlled (iPWM2 or LIN Bus)
- Unique LED user interface
- Self-protecting modes
- Designed for optimised integration

Options

- External control via iPWM
- Control mode Δp -c (constant), Δp -v (variable), constant speed
- Control mode selection and differential pressure setpoint setting for Δp -c, Δp -v via operating button
- Delivery in collective (180 pumps/package)

Type Key Example:

Technical data	
Approved fluids (other fluids on request)	
Drinking water and water for food-processing companies in accordance with TrinkwV 2001 (drinking water ordinance)	-
Water-glycol mixtures (max. 1:1; above 20% admixture, the pumping data must be checked)	•
Power	
Energy efficiency index (EEI)	≤ 0.20
Max. delivery head H_{max}	8.1 m
Max. volume flow Q_{max}	3.5 m ³ /h
Permitted field of application	
Temperature range at max. ambient temperature	-
Maximum static pressure p	10 bar

Electrical connection

• = appropriate, - = not appropriate

Technical data	
Mains connection	1~230 V, 50/60 Hz
Motor/electronics	
Electromagnetic compatibility	EN 61800-3
Emitted interference	EN 61000-6-3 / EN 61000-6-4
Speed control	Frequency converter
Interference resistance	EN 61000-6-2 / EN 61000-6-1
Protection class	IP X4D
Insulation class	F
Minimum suction head at suction port for avoiding cavitation at water pumping temperature	
Minimum suction head at 50 / 95 °C	0.5 / 4.5 m

• = appropriate, - = not appropriate

Motor data SC

Para ST	Speed	EEI	Power consumption 1~230 V	Current at 1~230V	Motor protection
	n rpm		P_1 W	I A	
ST 15-130/6-43/SC	2430 - 4300	≤ 0.20	3 - 43	0.04 - 0.44	integrated
ST 25-130/6-43/SC	2430 - 4300	≤ 0.20	3 - 43	0.04 - 0.44	integrated
ST 25-180/6-43/SC	2430 - 4300	≤ 0.20	3 - 43	0.04 - 0.44	integrated
ST 30-180/6-43/SC	2430 - 4300	≤ 0.20	3 - 43	0.04 - 0.44	integrated
ST 15-130/7-50/SC	2580 - 4700	≤ 0.20	6 - 50	0.07 - 0.44	integrated
ST 25-130/7-50/SC	2580 - 4700	≤ 0.20	6 - 50	0.07 - 0.44	integrated
ST 25-180/7-50/SC	2580 - 4700	≤ 0.20	6 - 50	0.07 - 0.44	integrated
ST 30-180/7-50/SC	2580 - 4700	≤ 0.20	6 - 50	0.07 - 0.44	integrated
ST 15-130/8-75/SC	3000 - 4800	≤ 0.21	10 - 75	0.03 - 0.66	integrated
ST 25-130/8-75/SC	3000 - 4800	≤ 0.21	10 - 75	0.03 - 0.66	integrated
ST 25-180/8-75/SC	3000 - 4800	≤ 0.21	10 - 75	0.03 - 0.66	integrated
ST 30-180/8-75/SC	3000 - 4800	≤ 0.21	10 - 75	0.03 - 0.66	integrated

Motor data IPWM/LIN

Para ST	Speed	EEI	Power consumption 1~230 V	Current at 1~230V	Motor protection
	n rpm		P_1 W	I A	
ST 15-130/6-43*	700 - 4300	≤ 0.20	1 - 43	0.04 - 0.44	integrated
ST 25-130/6-43*	700 - 4300	≤ 0.20	1 - 43	0.04 - 0.44	integrated
ST 25-180/6-43*	700 - 4300	≤ 0.20	1 - 43	0.04 - 0.44	integrated
ST 30-180/6-43*	700 - 4300	≤ 0.20	1 - 43	0.04 - 0.44	integrated
ST 15-130/7-50*	700 - 4700	≤ 0.20	1 - 50	0.02 - 0.44	integrated
ST 25-130/7-50*	700 - 4700	≤ 0.20	1 - 50	0.02 - 0.44	integrated
ST 25-180/7-50*	700 - 4700	≤ 0.20	1 - 50	0.02 - 0.44	integrated
ST 30-180/7-50*	700 - 4700	≤ 0.20	1 - 50	0.02 - 0.44	integrated
ST 15-130/8-75*	500 - 4800	≤ 0.21	2 - 75	0.03 - 0.66	integrated
ST 25-130/8-75*	500 - 4800	≤ 0.21	2 - 75	0.03 - 0.66	integrated
ST 25-180/8-75*	500 - 4800	≤ 0.21	2 - 75	0.03 - 0.66	integrated
ST 30-180/8-75*	500 - 4800	≤ 0.21	2 - 75	0.03 - 0.66	integrated

*iPWM2 or LIN

Pump curves

$\Delta p-v$ (variable)

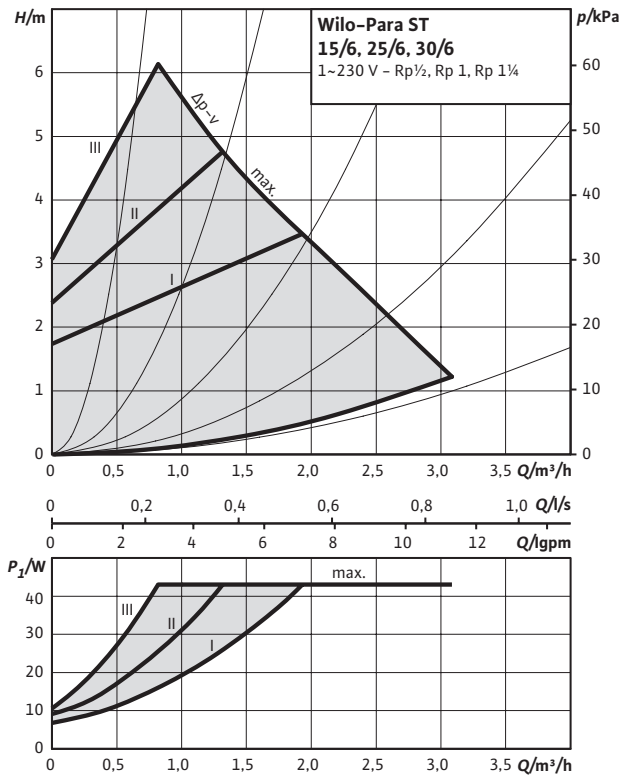

Pump curves

$\Delta p-c$ (constant)

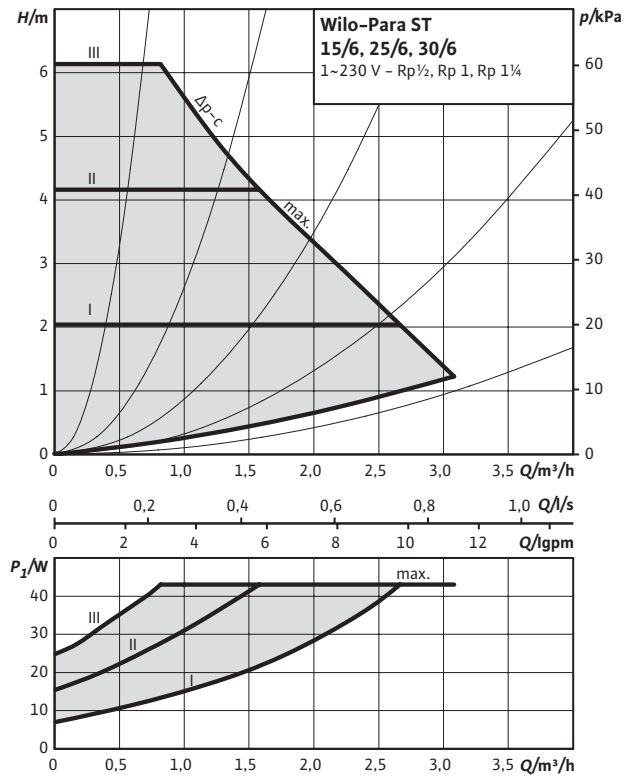

Pump curves

Constant speed I, II, III

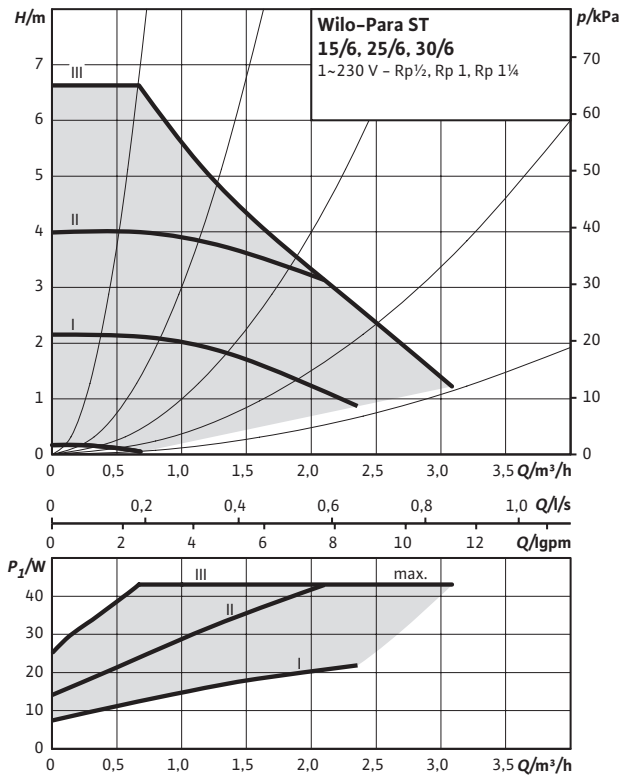

Pump curves

External control via PWM2/LIN

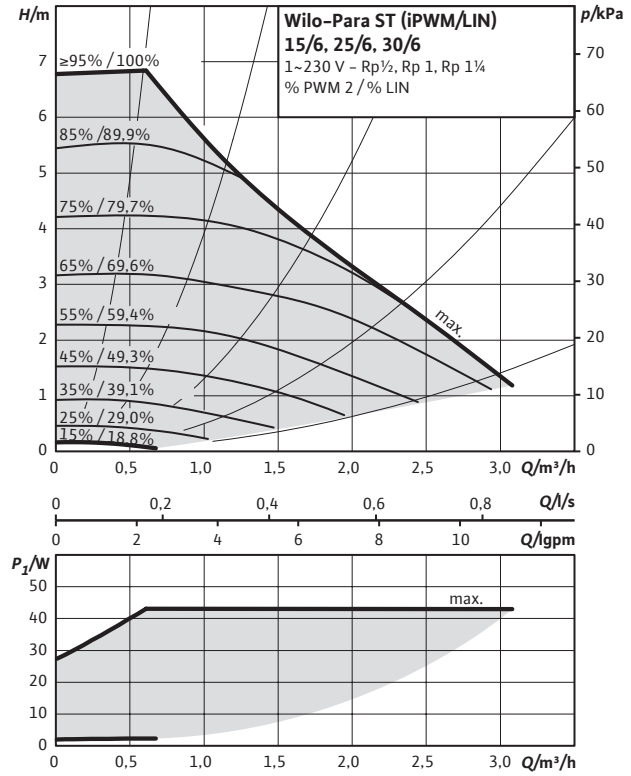

Pump curves

$\Delta p-v$ (variable)

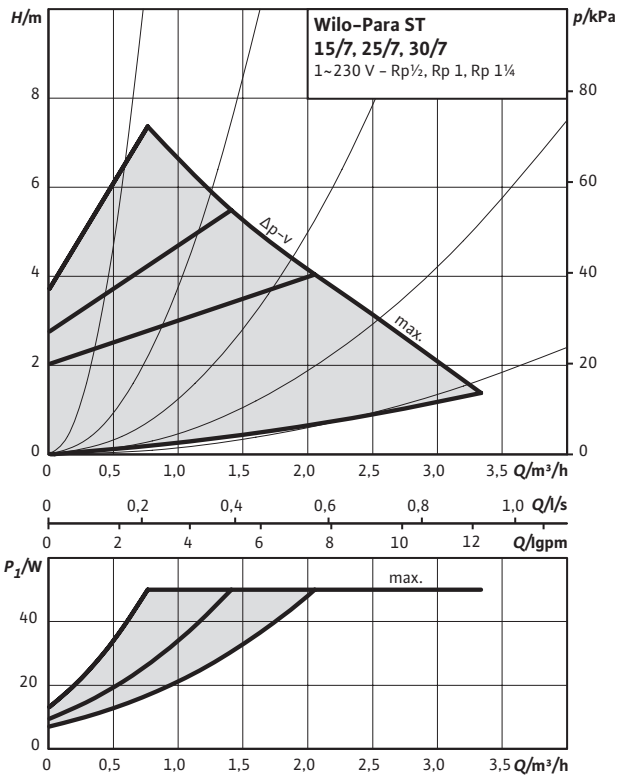

Pump curves

$\Delta p-c$ (constant)

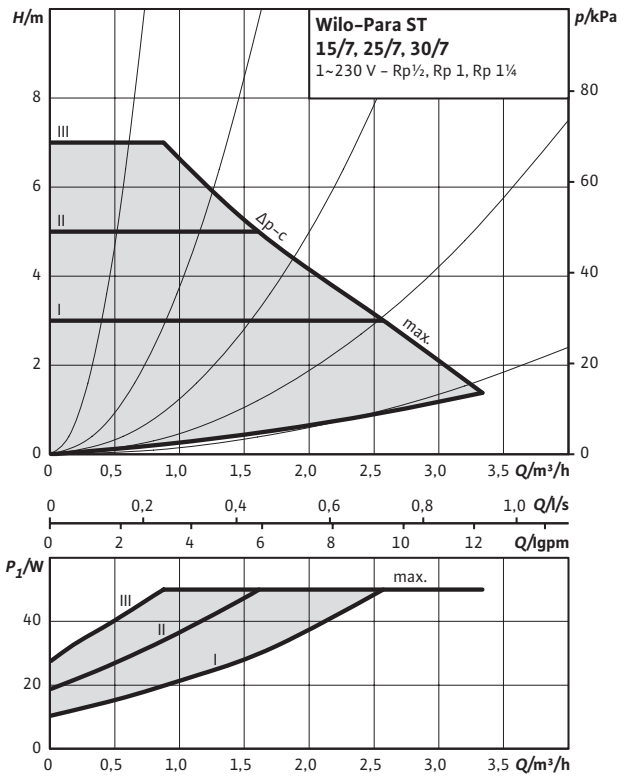

Pump curves

Constant speed I, II, III

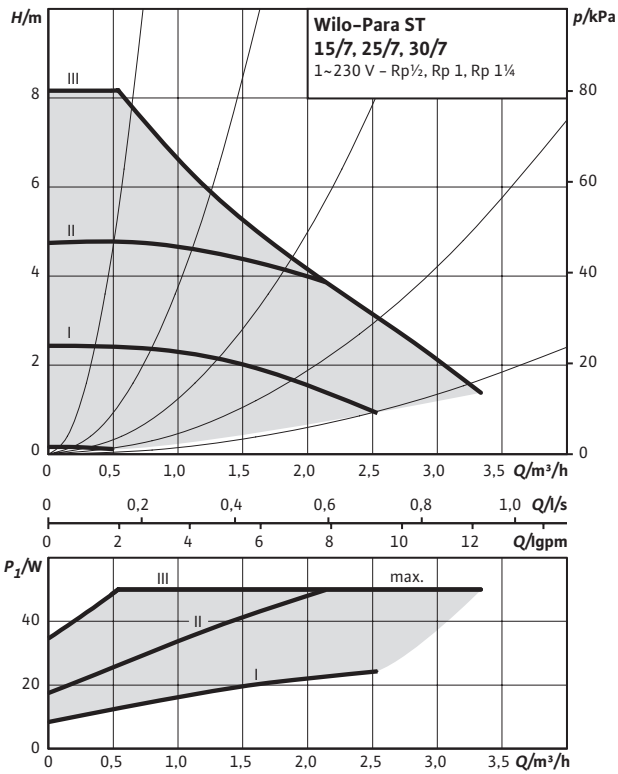

Pump curves

External control via PWM2/LIN

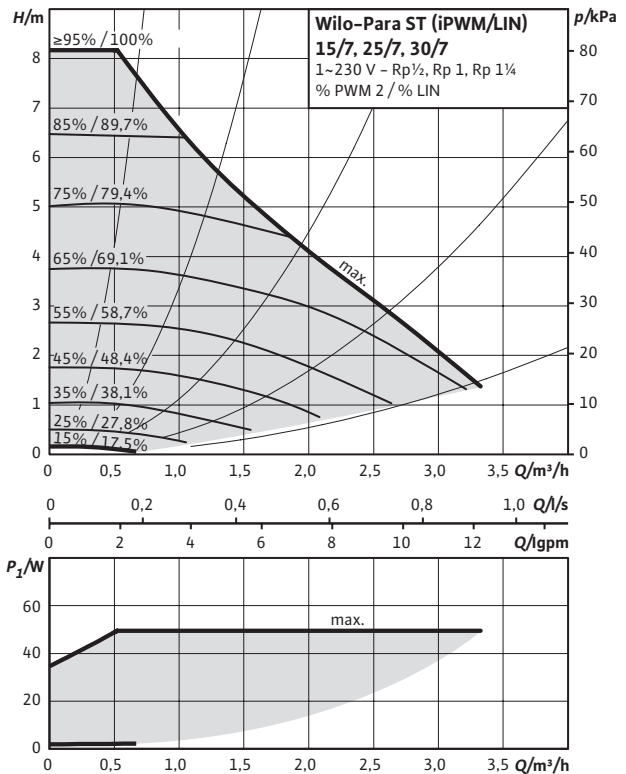

Pump curves

$\Delta p-v$ (variable)

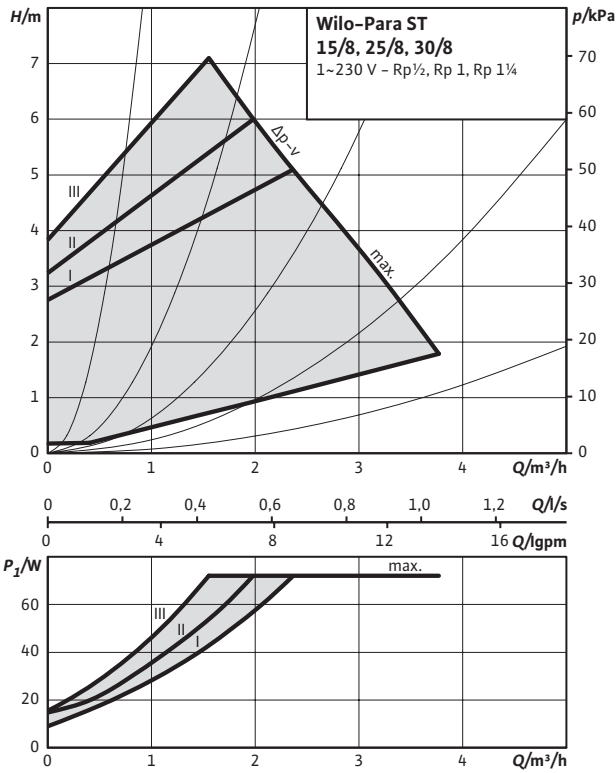

Pump curves

$\Delta p-c$ (constant)

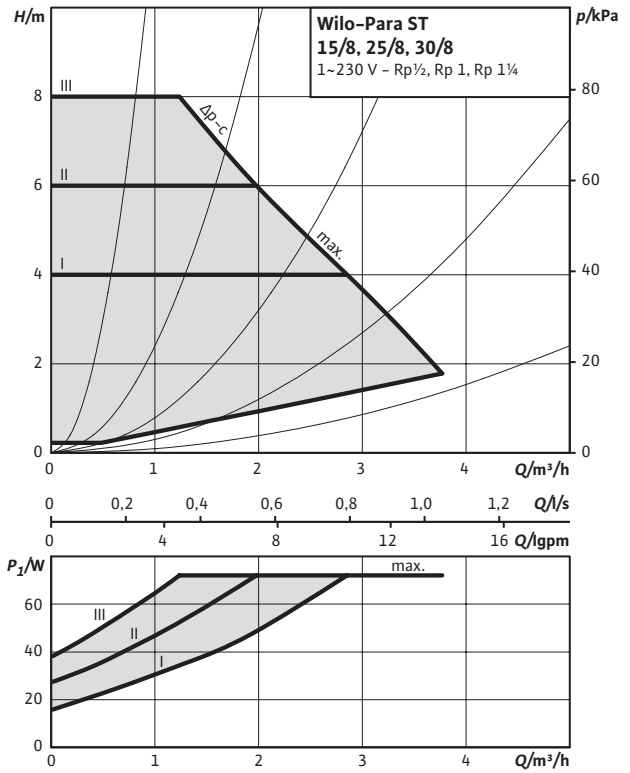

Pump curves

Constant speed I, II, III

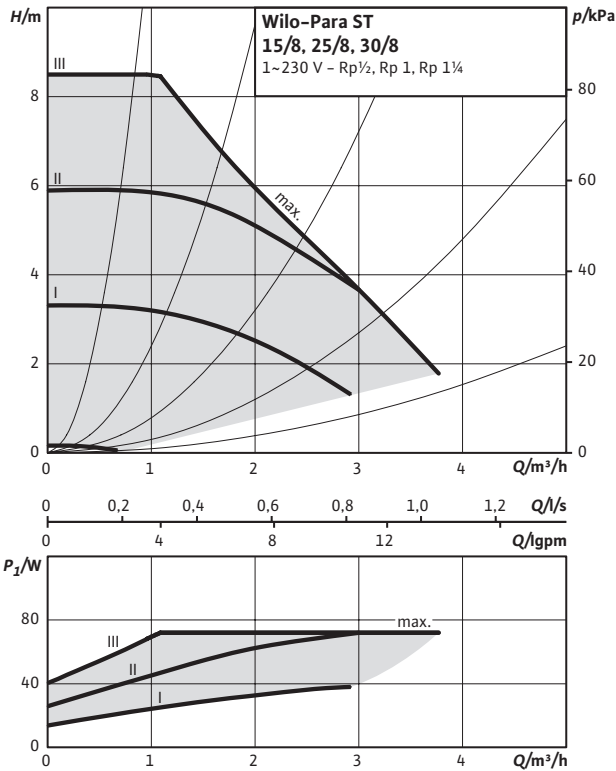

Pump curves

External control via PWM2/LIN

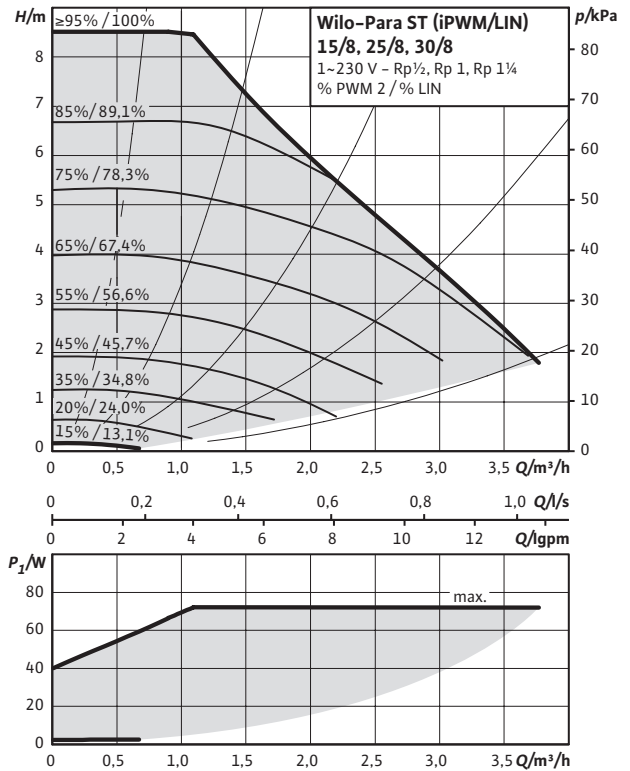

Dimension drawing SC

Wilo-Para ST

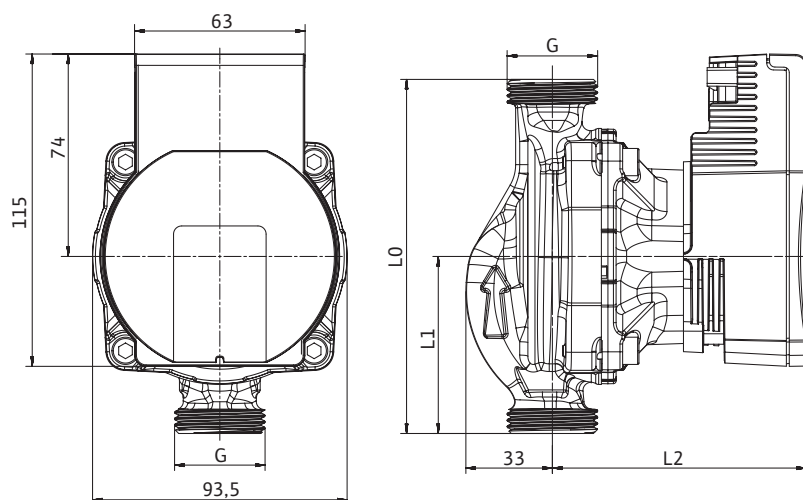

Technical data			
Designation	Para ST 15-130/6-43/SC	Para ST 15-130/7-50/SC	Para ST 15-130/8-75/SC
Threaded pipe union	Rp 1/2		
Thread	G 1		
Overall length l_0	130 mm		
Dimensions L1	65 mm		
Dimensions L2	94 mm		105 mm
Weight approx. m	1.54 kg		1.7 kg

Technical data						
Designation	Para ST 25-130/6-43/SC	Para ST 25-180/6-43/SC	Para ST 25-130/8-75/SC	Para ST 25-130/7-50/SC	Para ST 25-180/7-50/SC	Para ST 25-180/8-75/SC
Threaded pipe union	Rp 1					
Thread	G 1 1/2					
Overall length l_0	130 mm	180 mm	130 mm	130 mm	180 mm	180 mm
Dimensions L1	65 mm	90 mm	65 mm	90 mm	65 mm	90 mm
Dimensions L2	94 mm			105 mm		
Weight approx. m	1.66 kg	1.78 kg	1.8 kg	1.66 kg	1.78 kg	2 kg

Technical data			
Designation	Para ST 30-180/6-43/SC	Para ST 30-180/7-50/SC	Para ST 30-180/8-75/SC
Threaded pipe union	Rp 1 1/4		
Thread	G 2		
Overall length l_0	180 mm		
Dimensions L1	90 mm		
Dimensions L2	94 mm		105 mm
Weight approx. m	1.96 kg		2.1 kg

Materials

Pump housing	Cast iron with cathaphoresis treatment
Impeller	PP composite with GF 40%
Pump shaft	Stainless steel
Bearing	Carbon, metal impregnated

Dimension drawing iPWM/LIN

Wilo-Para ST

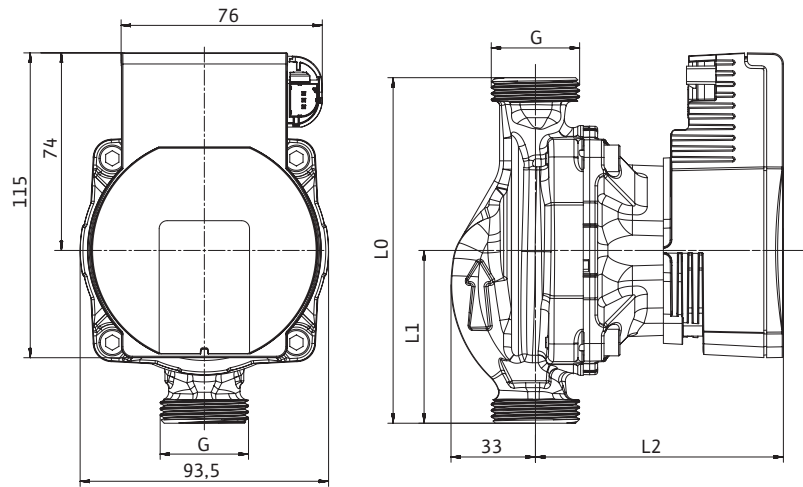

Technical data

Designation	Para ST 15-130/6-43*	Para ST 15-130/7-50*	Para ST 15-130/8-75*
Threaded pipe union		Rp 1/2	
Thread		G 1	
Overall length l_0		130 mm	
Dimensions $L1$		65 mm	
Dimensions $L2$		94 mm	105 mm
Weight approx. m		1.54 kg	1.7 kg

Technical data

Designation	Para ST 25-130/ 6-43*	Para ST 25-180/ 6-43*	Para ST 25-130/ 7-50*	Para ST 25-180/ 7-50*	Para ST 25-130/ 8-75*	Para ST 25-180/ 8-75*
Threaded pipe union					Rp 1	
Thread					G 1 1/2	
Overall length l_0	130 mm	180 mm	130 mm	180 mm	130 mm	180 mm
Dimensions $L1$	65 mm	90 mm	65 mm	90 mm	65 mm	90 mm
Dimensions $L2$			94 mm			105 mm
Weight approx. m	1.66 kg	1.78 kg	1.66 kg	1.78 kg	1.8 kg	2 kg

Technical data

Designation	Para ST 30-180/6-43*	Para ST 30-180/7-50*	Para ST 30-180/8-75*
Threaded pipe union			Rp 1 1/4
Thread			G 2
Overall length l_0			180 mm
Dimensions $L1$			90 mm
Dimensions $L2$		94 mm	105 mm
Weight approx. m		1.96 kg	2.1 kg

Materials

Pump housing	Cast iron with cathaphoresis treatment
Impeller	PP composite with GF 40%
Pump shaft	Stainless steel
Bearing	Carbon, metal impregnated

*iPWM2 or LIN



Geothermal energy systems





Wilo-Para G



Glandless circulation pump with a cast iron pump housing, corrosion-protected motor housing and screws, threaded connection.

- Self-controlled pump (operating button) or externally controlled (iPWM1 or LIN bus)
- Unique LED user interface
- Self-protecting modes
- Designed for optimised integration

Type
Wilo-Para G

Page
137



Wilo-Para STG



Glandless circulation pump with a cast iron pump housing and threaded connection. EC motor with automatic power adjustment and self-protecting modes.

- Self-controlled pump (operating button) or externally controlled (iPWM1 and iPWM2 signal)
- Unique LED user interface
- Self-protecting modes
- Designed for optimised integration

Type
Wilo-Para STG

Page
98



Wilco-Yonos PARA High Flow



Glandless circulation pump with cast iron pump housing and threaded connection. EC-motor with automatic power adjustment.

Type	Page
Wilco-Yonos PARA High Flow 25/7, 30/7	102
Wilco-Yonos PARA High Flow 25/10, 30/10	104
Wilco-Yonos PARA High Flow 25/12, 30/12	106



Wilco-Stratos PARA



Glandless circulator with screwed connection. EC motor with automatic power adjustment. Supplied as standard with cable for easy electrical connection.

Type	Page
Wilco-Stratos PARA 25/1-8, 30/1-8	108
Wilco-Stratos PARA 25/1-11, 30/1-11	112
Wilco-Stratos PARA 25/1-12, 30/1-12	116

Technical data								
Type	Wilo-							
	Para G 15/6 SC Para G 25/6 SC Para G 30/6 SC	Para G 15/7 SC Para G 25/7 SC Para G 30/7 SC	Para G 15/8 SC Para G 25/8 SC Para G 30/8 SC	Para G 25/9 SC	Para G 15/6* Para G 25/6* Para G 30/6*	Para G 15/7* Para G 25/7* Para G 30/7*	Para G 15/8* Para G 25/8* Para G 30/8*	Para G 25/9 iPWM1
Operating modes								
Manual control mode (n=constant)	Operating button	Operating button	Operating button	Operating button	via PWM/LIN	via PWM/LIN	via PWM/LIN	via PWM
Δp-c for constant differential pressure	✓	✓	✓	✓	-	-	-	-
Δp-v for variable differential pressure	✓	✓	✓	✓	-	-	-	-
Manual functions								
Operating mode setting	✓	✓	✓	✓	-	-	-	-
Differential-pressure setpoint setting	✓	✓	✓	✓	-	-	-	-
Automatic functions								
Infinitely variable power adjustment depending on the operating mode	-	-	-	-	✓	✓	✓	✓
Deblocking function	✓	✓	✓	✓	✓	✓	✓	✓
Soft start	✓	✓	✓	✓	✓	✓	✓	✓
Full motor protection with integrated trip electronics	✓	✓	✓	✓	✓	✓	✓	✓
Venting routine	✓	✓	✓	✓	-	-	-	-
External control functions								
Control input "Analog In 0 ... 10 V" with cable break function (remote speed adjustment)	-	-	-	-	-	-	-	-
Control input "Analog In 0 ... 10 V" without cable break function (remote setpoint adjustment)	-	-	-	-	-	-	-	-
Control input PWM or LIN	-	-	-	-	✓	✓	✓	✓
Signal and display functions								
Collective run signal	-	-	-	-	-	-	-	-
Equipment/scope of delivery								
Operating button	✓	✓	✓	✓	-	-	-	-
Version without operating button (=external control)	-	-	-	-	✓	✓	✓	✓
Wrench attachment point on pump body	✓	✓	✓	✓	✓	✓	✓	✓
Including power cable	on request	on request	on request	on request	on request	on request	on request	on request
Including power plug	✓	✓	✓	✓	✓	✓	✓	✓
Including control cable	-	-	-	-	on request	on request	on request	on request
Including seals for threaded connection (loose)	on request	on request	on request	on request	on request	on request	on request	on request
Including installation and operating instructions	on request	on request	on request	on request	on request	on request	on request	on request
Including thermal insulation	on request	on request	on request	on request	on request	on request	on request	on request
Incl. Cooling-Shell	on request	on request	on request	on request	on request	on request	on request	on request
Individual packaging	on request	on request	on request	on request	on request	on request	on request	on request
Collective packaging	✓	✓	✓	✓	✓	✓	✓	✓

✓ = equipped with
 - = not equipped with

*iPWM1 or LIN

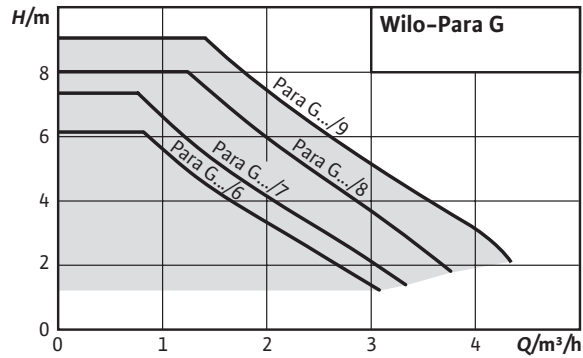

Wilo-Para G



Design

Glandless circulation pump with a cast iron pump housing, corrosion-protected motor housing and screws, threaded connection.

Application

Circulation in Geothermal systems in the medium temperature range of -20°C to $+95^{\circ}\text{C}$.

Type key

Example: **Para G 15-130/7-50/SC**

Para Electronically controlled high-efficiency pump pump range adapted to requirements of the OEM market

Heating inline cast iron pump housing

G Standard cast iron pump housing, corrosion-protected motor, housing and screws

15-130 Nominal diameter - Pump housing length

15 threading 1"

25 threading 1 1/2"

30 threading 2"

7-50 Nominal delivery head range [m] -

Power consumption

SC control:

SC = Self Controlled pump

or

PWM1 = the pump is controlled by an external system via PWM1 or iPWM1 signal

LIN = the pump is controlled by an external system via Lin Bus Communication

12 Position of electronic module

- Self-controlled pump (operating button) or externally controlled (iPWM1 or LIN Bus)
- Unique LED user interface
- Self-protecting modes
- Designed for optimised integration

Options

- External control via iPWM or LIN
- Control mode Δp -c (constant), Δp -v (variable), constant speed
- Control mode selection and differential pressure setpoint setting for Δp -c, Δp -v via operating button

Type Key Example:

Technical data	
Approved fluids (other fluids on request)	
Drinking water and water for food-processing companies in accordance with TrinkwV 2001 (drinking water ordinance)	-
Water-glycol mixtures (max. 1:1; above 20% admixture, the pumping data must be checked)	•
Power	
Energy efficiency index (EEI)	≤ 0.20
Max. delivery head H_{max}	8.40 m
Max. volume flow Q_{max}	4.0 m ³ /h
Permitted field of application	
Temperature range at max. ambient temperature	of 58°C = 0 to 100°C of 62°C = 0 to 90°C of 66°C = 0 to 80°C of 71°C = 0 to 70°C
Maximum static pressure p	10 bar

• = appropriate, - = not appropriate

Technical data	
Electrical connection	
Mains connection	1-230 V, 50/60 Hz
Motor/electronics	
Electromagnetic compatibility	EN 61800-3
Emitted interference	EN 61000-6-3 / EN 61000-6-4
Speed control	Frequency converter
Interference resistance	EN 61000-6-2 / EN 61000-6-1
Protection class	IP X4D
Insulation class	F
Minimum suction head at suction port for avoiding cavitation at water pumping temperature	
Minimum suction head at 50 / 95 °C	0.5 / 4.5 m

• = appropriate, - = not appropriate

Motor data SC					
Para...	Speed	EEl	Power consumption 1~230 V	Current at 1~230V	Motor protection
	<i>n</i> rpm		P_1 W	<i>I</i> A	
G 15-130/6-43/SC	2430 - 4300	≤ 0.20	3 - 43	0.04 - 0.44	integrated
G 25-130/6-43/SC	2430 - 4300	≤ 0.20	3 - 43	0.04 - 0.44	integrated
G 25-180/6-43/SC	2430 - 4300	≤ 0.20	3 - 43	0.04 - 0.44	integrated
G 30-180/6-43/SC	2430 - 4300	≤ 0.20	3 - 43	0.04 - 0.44	integrated
G 15-130/7-50/SC	2580 - 4700	≤ 0.20	6 - 50	0.07 - 0.44	integrated
G 25-130/7-50/SC	2580 - 4700	≤ 0.20	6 - 50	0.07 - 0.44	integrated
G 25-180/7-50/SC	2580 - 4700	≤ 0.20	6 - 50	0.07 - 0.44	integrated
G 30-180/7-50/SC	2580 - 4700	≤ 0.20	6 - 50	0.07 - 0.44	integrated
G 15-130/8-75/SC	3000 - 4800	≤ 0.21	10 - 75	0.03 - 0.66	integrated
G 25-130/8-75/SC	3000 - 4800	≤ 0.21	10 - 75	0.03 - 0.66	integrated
G 25-180/8-75/SC	3000 - 4800	≤ 0.21	10 - 75	0.03 - 0.66	integrated
G 30-180/8-75/SC	3000 - 4800	≤ 0.21	10 - 75	0.03 - 0.66	integrated
G 25-130/9-87/SC	2610 - 4540	≤ 0.21	13 - 87	0.03 - 0.66	integrated
G 25-180/9-87/SC	2610 - 4540	≤ 0.21	13 - 87	0.03 - 0.66	integrated

Motor data IPWM/LIN					
Para...	Speed	EEl	Power consumption 1~230 V	Current at 1~230V	Motor protection
	<i>n</i> rpm		P_1 W	<i>I</i> A	
G 15-130/6-43*	700 - 4300	≤ 0.20	1 - 43	0.04 - 0.44	integrated
G 25-130/6-43*	700 - 4300	≤ 0.20	1 - 43	0.04 - 0.44	integrated
G 25-180/6-43*	700 - 4300	≤ 0.20	1 - 43	0.04 - 0.44	integrated
G 30-180/6-43*	700 - 4300	≤ 0.20	1 - 43	0.04 - 0.44	integrated
G 15-130/7-50*	700 - 4700	≤ 0.20	1 - 50	0.02 - 0.44	integrated
G 25-130/7-50*	700 - 4700	≤ 0.20	1 - 50	0.02 - 0.44	integrated
G 25-180/7-50*	700 - 4700	≤ 0.20	1 - 50	0.02 - 0.44	integrated
G 30-180/7-50*	700 - 4700	≤ 0.20	1 - 50	0.02 - 0.44	integrated
G 15-130/8-75*	500 - 4800	≤ 0.21	2 - 75	0.03 - 0.66	integrated
G 25-130/8-75*	500 - 4800	≤ 0.21	2 - 75	0.03 - 0.66	integrated
G 25-180/8-75*	500 - 4800	≤ 0.21	2 - 75	0.03 - 0.66	integrated
G 30-180/8-75*	500 - 4800	≤ 0.21	2 - 75	0.03 - 0.66	integrated
G 25-130/9-87/IPWM1	500 - 4540	≤ 0.21	3 - 87	0.03 - 0.66	integrated
G 25-180/9-87/IPWM1	500 - 4540	≤ 0.21	3 - 87	0.03 - 0.66	integrated

*iPWM1 or LIN

Pump curves

$\Delta p-v$ (variable)

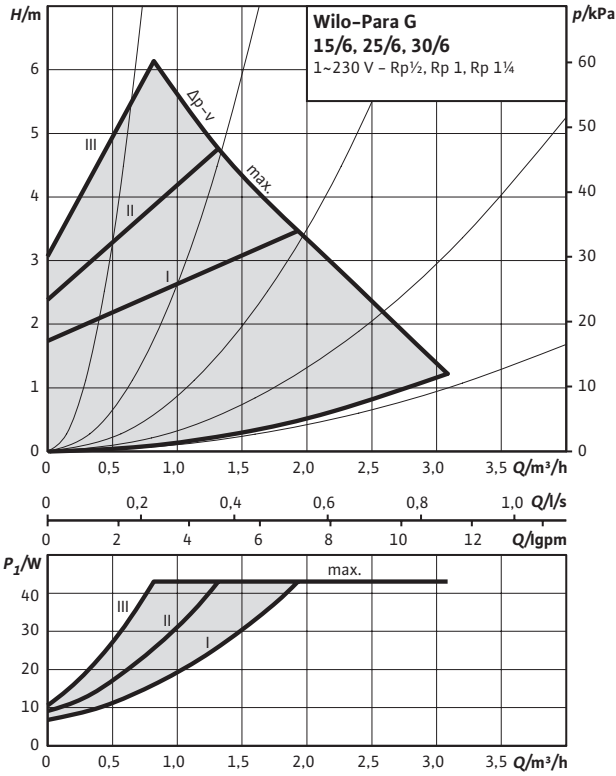

Pump curves

$\Delta p-c$ (constant)

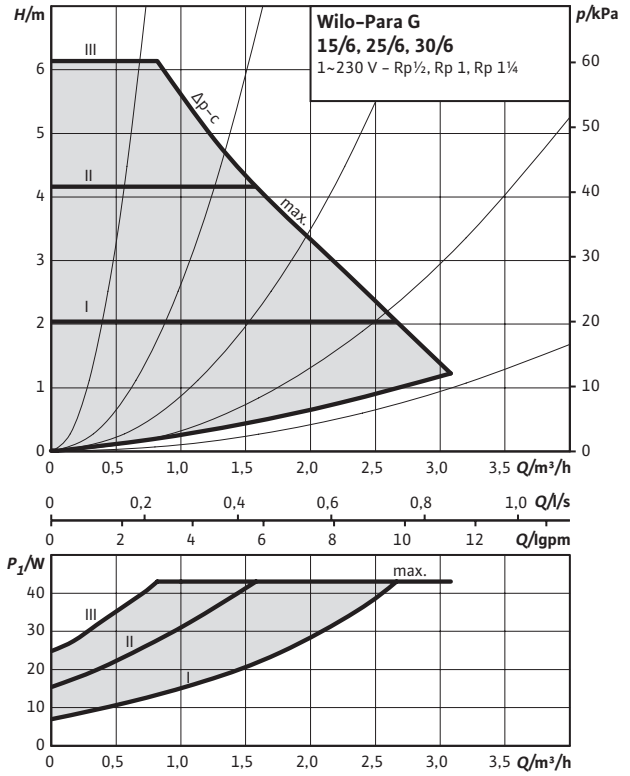

Pump curves

Constant speed I, II, III

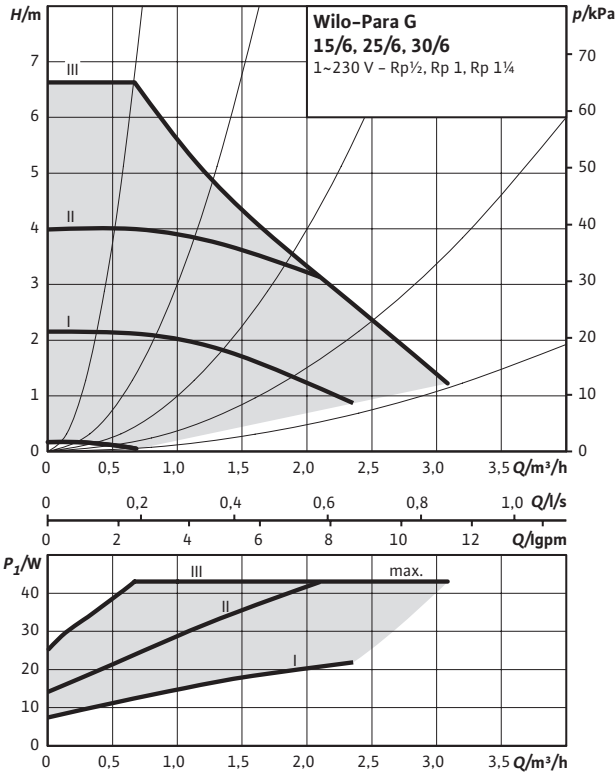

Pump curves

External control via PWM/LIN

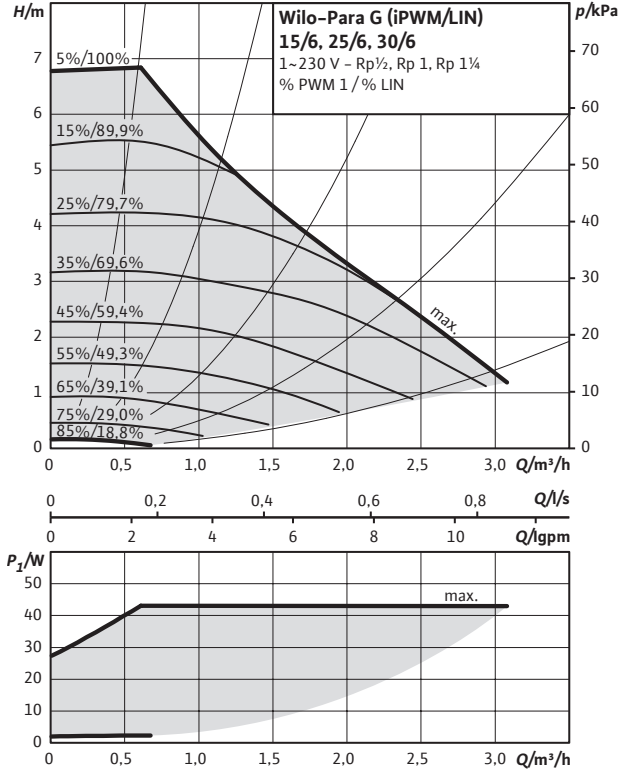

Pump curves

$\Delta p-v$ (variable)

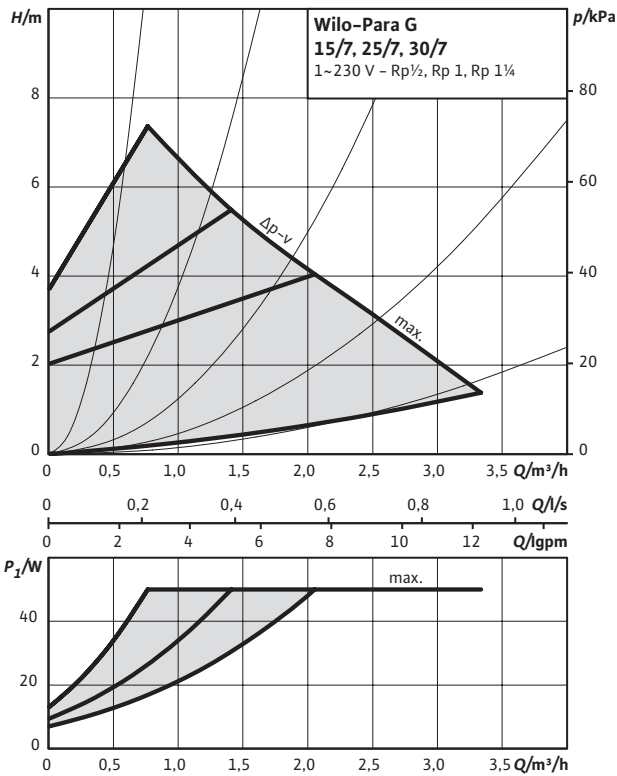

Pump curves

$\Delta p-c$ (constant)

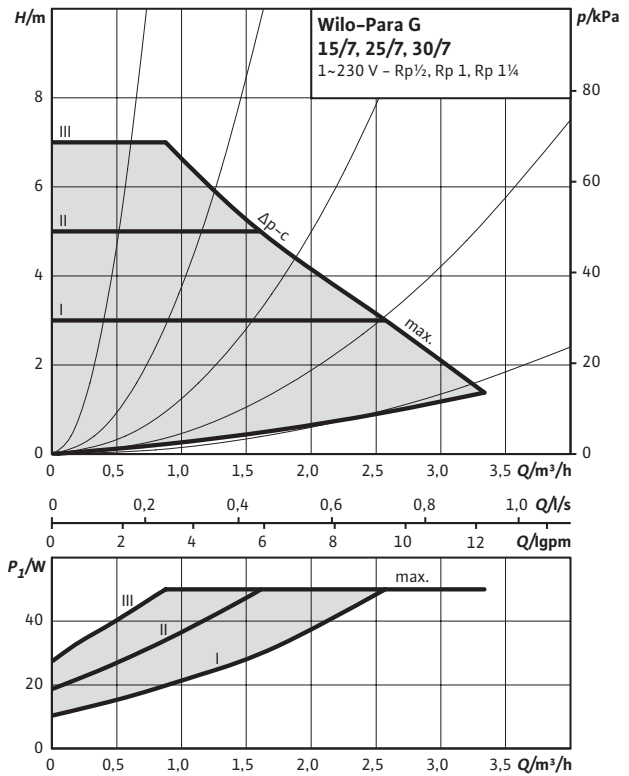

Pump curves

Constant speed I, II, III

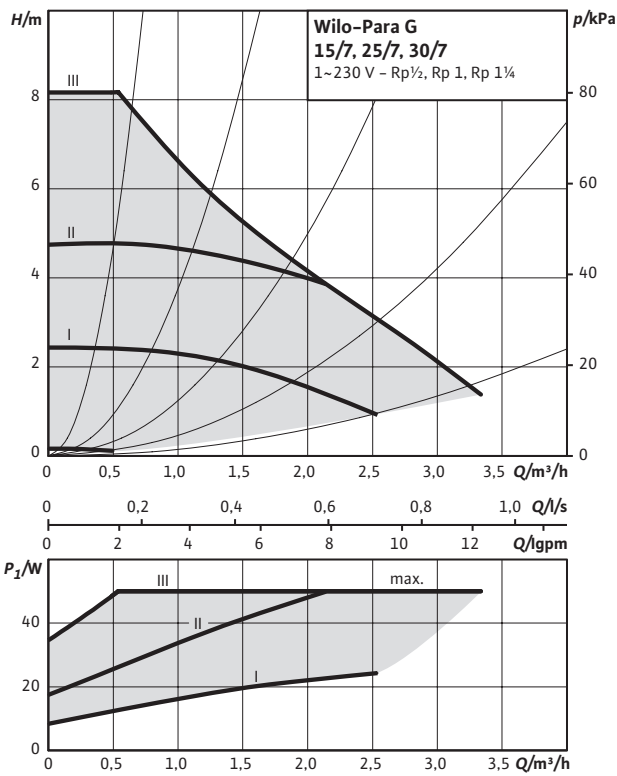

Pump curves

External control via PWM1/LIN

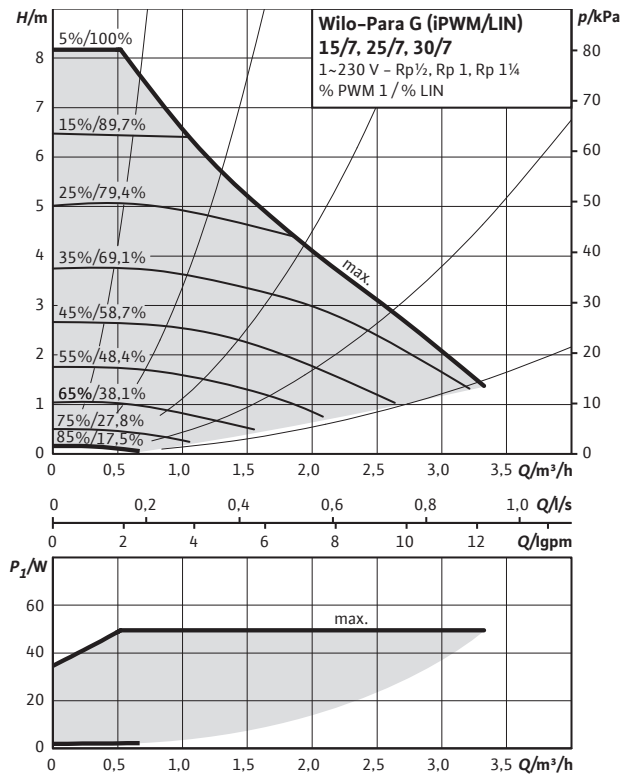

Pump curves

$\Delta p-v$ (variable)

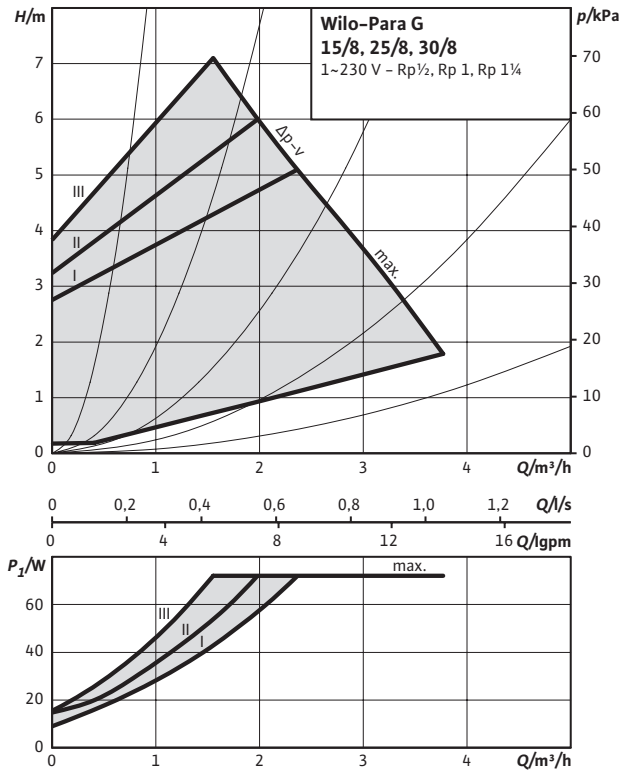

Pump curves

$\Delta p-c$ (constant)

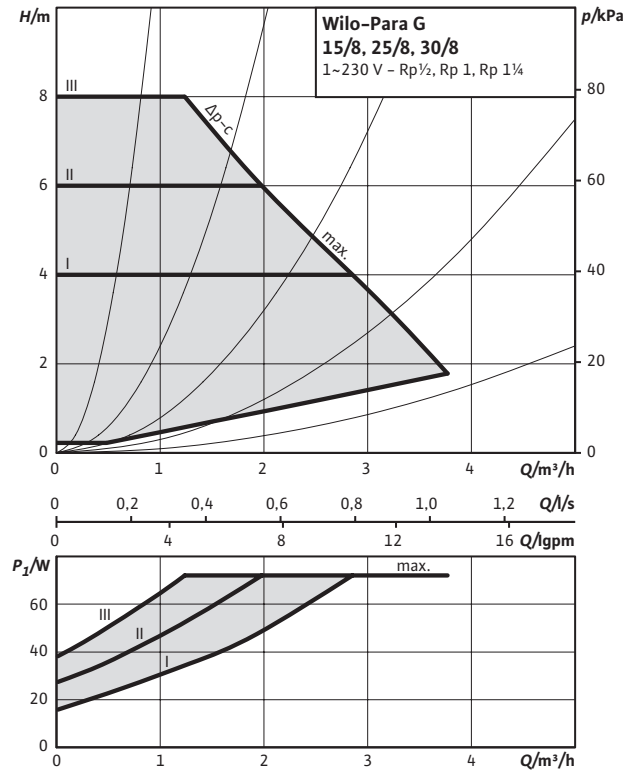

Pump curves

Constant speed I, II, III

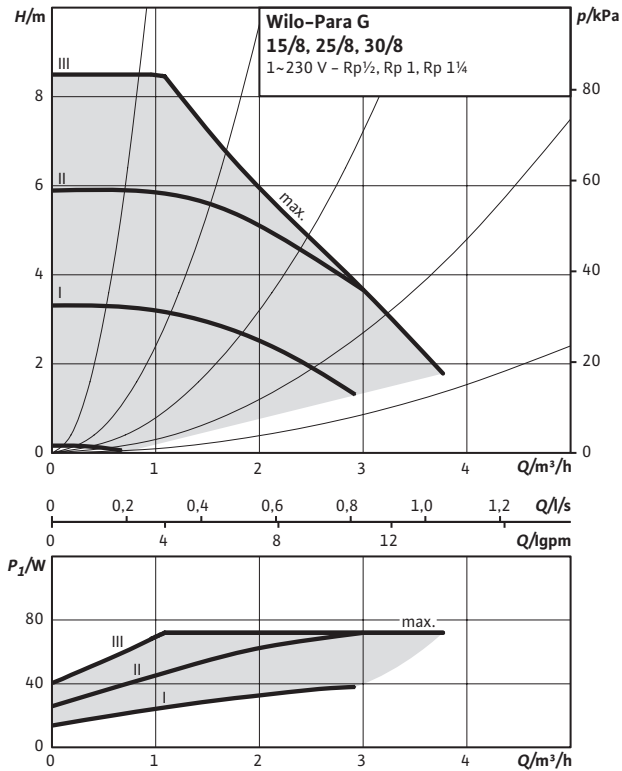

Pump curves

External control PWM1/LIN

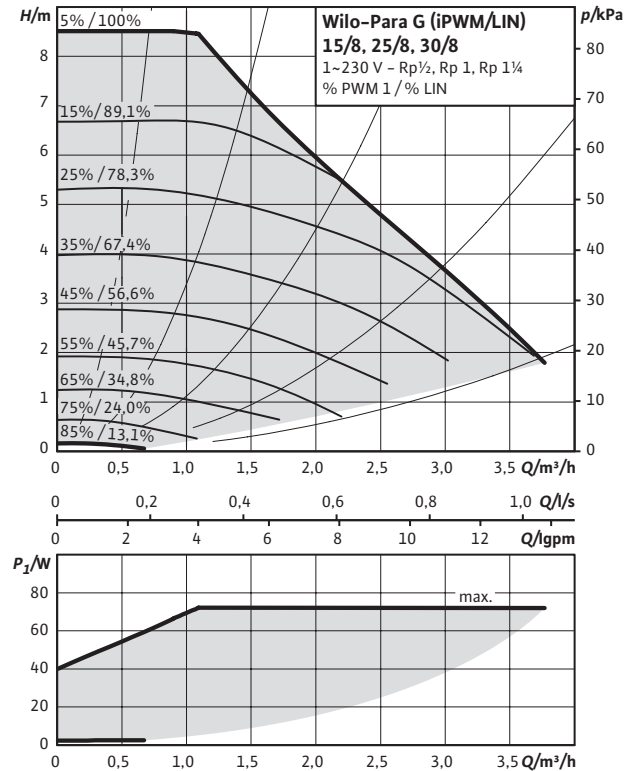

Pump curves

$\Delta p-v$ (variable)

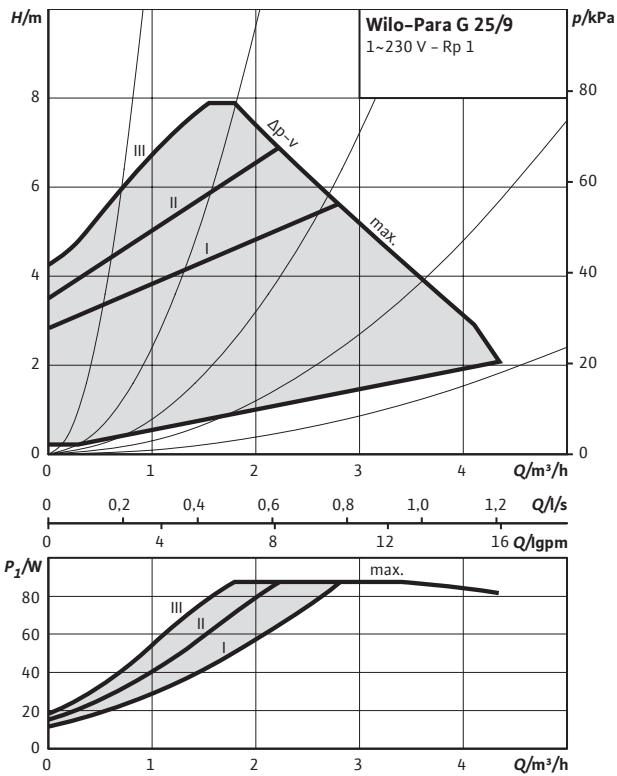

Pump curves

$\Delta p-c$ (constant)

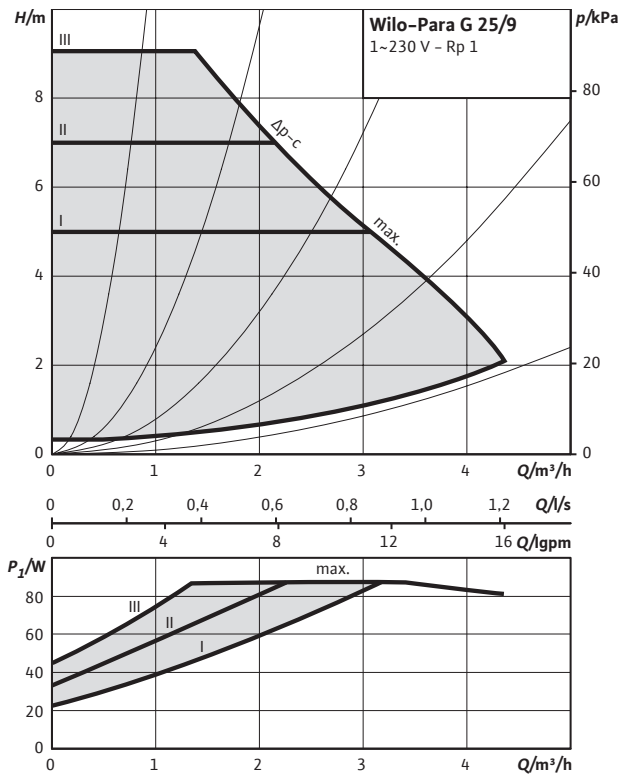

Pump curves

Constant speed I, II, III

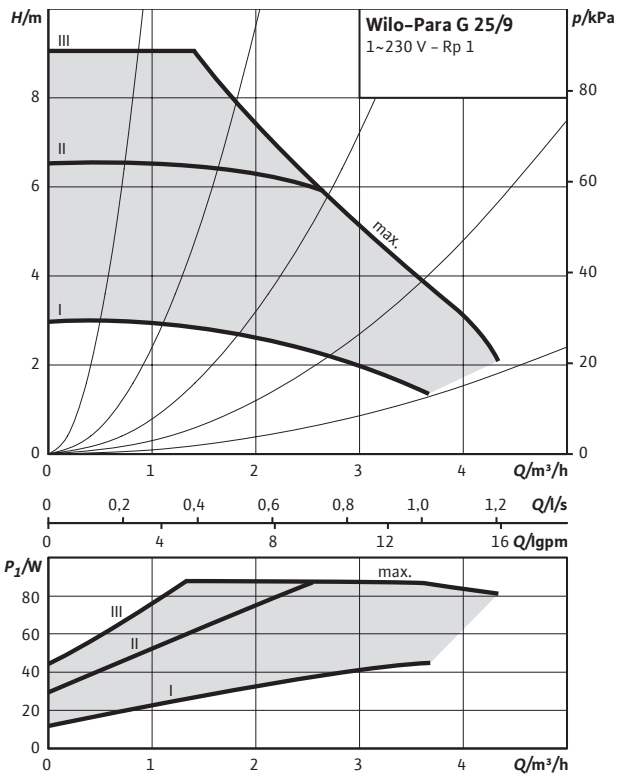

Pump curves

External control via PWM1

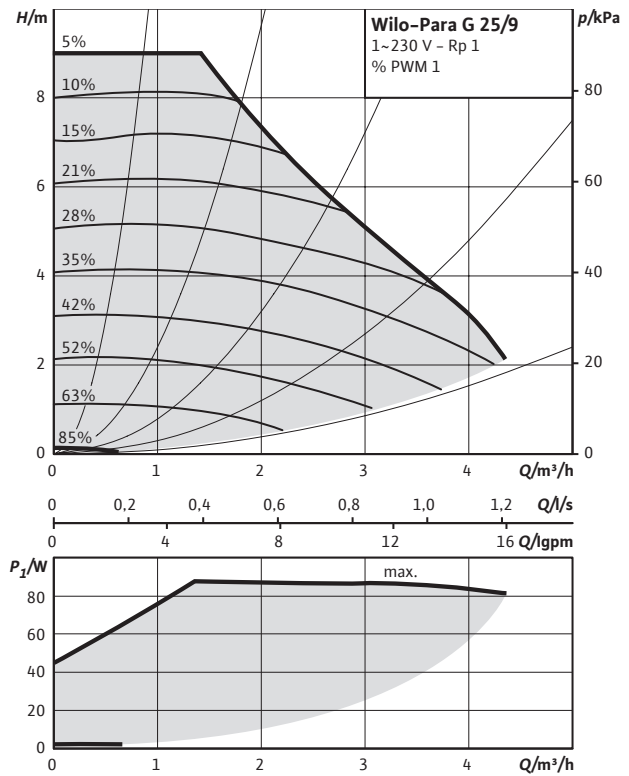

Dimension drawing SC
Wilo-Para G

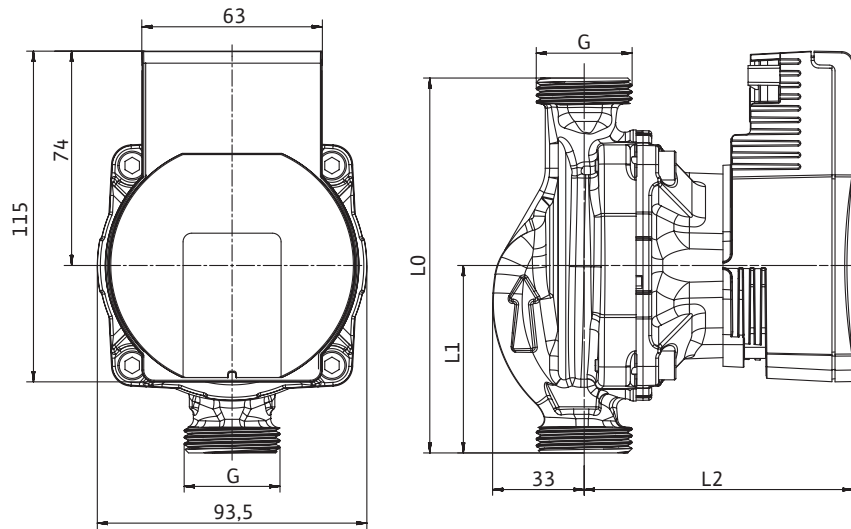

Technical data			
Designation	Para G 15-130/6-43/SC	Para G 15-130/7-50/SC	Para G 15-130/8-75/SC
Threaded pipe union			Rp 1/2
Thread			G 1
Overall length l_0			130 mm
Dimensions $L1$			65 mm
Dimensions $L2$		94 mm	105 mm
Weight approx. m		1.54 kg	1.7 kg

Technical data								
Designation	Para G 25-130/6-43/SC	Para G 25-180/6-43/SC	Para G 25-130/7-50/SC	Para G 25-180/7-50/SC	Para G 25-130/8-75/SC	Para G 25-180/8-75/SC	Para G 25-130/9-87/SC	Para G 25-180/9-87/SC
Threaded pipe union	Rp 1							
Thread	G 1 1/2							
Overall length l_0	130 mm	180 mm	130 mm	180 mm	130 mm	180 mm	130 mm	180 mm
Dimensions $L1$	65 mm	90 mm	65 mm	90 mm	65 mm	90 mm	65 mm	90 mm
Dimensions $L2$	94 mm				105 mm			
Weight approx. m	1.66 kg	1.78 kg	1.66 kg	1.78 kg	1.8 kg	2 kg	2 kg	2.2 kg

Technical data			
Designation	Para G 30-180/6-43/SC	Para G 30-180/7-50/SC	Para G 30-180/8-75/SC
Threaded pipe union			Rp 1 1/4
Thread			G 2
Overall length l_0			180 mm
Dimensions $L1$			90 mm
Dimensions $L2$		94 mm	105 mm
Weight approx. m		1.96 kg	2.1 kg

Materials

Pump housing	Cast iron with cataphoresis treatment
Impeller	PP composite with GF 40%
Pump shaft	Stainless steel
Bearing	Carbon, metal impregnated

Dimension drawing iPWM1

Wilo-Para G

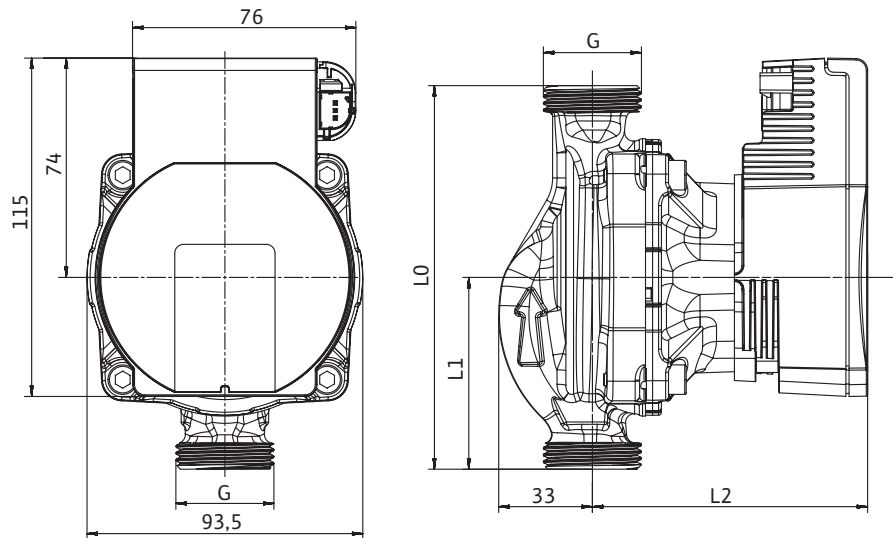

Technical data			
Designation	Para G 15-130/6-43*	Para G 15-130/7-50*	Para G 15-130/8-75*
Threaded pipe union		Rp 1/2	
Thread		G 1	
Overall length l_0		130 mm	
Dimensions $L1$		65 mm	
Dimensions $L2$		94 mm	105 mm
Weight approx. m		1.54 kg	1.7 kg

Technical data								
Designation	Para G 25-130/6-43*	Para G 25-180/6-43*	Para G 25-130/7-50*	Para G 25-180/7-50*	Para G 25-130/8-75*	Para G 25-180/8-75*	Para G 25-130/9-87/iPWM1	Para G 25-180/9-87/iPWM1
Threaded pipe union	Rp 1							
Thread	G 1 1/2							
Overall length l_0	130 mm	180 mm	130 mm	180 mm	130 mm	180 mm	130 mm	180 mm
Dimensions $L1$	65 mm	90 mm	65 mm	90 mm	65 mm	90 mm	65 mm	90 mm
Dimensions $L2$	94 mm				105 mm			
Weight approx. m	1.66 kg	1.78 kg	1.66 kg	1.78 kg	1.8 kg	2 kg	2 kg	2.2 kg

Technical data			
Designation	Para G 30-180/6-43*	Para G 30-180/7-50*	Para G 30-180/8-75*
Threaded pipe union		Rp 1 1/4	
Thread		G 2	
Overall length l_0		180 mm	
Dimensions $L1$		90 mm	
Dimensions $L2$		94 mm	105 mm
Weight approx. m		1.96 kg	2.1 kg

Materials

Pump housing	Cast iron with cathaphoresis treatment
Impeller	PP composite with GF 40%
Pump shaft	Stainless steel
Bearing	Carbon, metal impregnated

*iPWM1 or LIN

Domestic hot water





Wilco-Yonos PARA-Z



Glandless circulation pump with a brass pump housing and threaded connection. EC motor with automatic power adjustment and self-protecting modes. Operation by Red Knob technology or remote control via external PWM signal. Equipped with LED user interface.

- Red Knob technology or PWM controlled
- Unique LED user interface
- Self-protecting modes
- Designed for optimised integration
- Self controlled pump (Red Knob) or externally controlled (PWM signal)
- WRAS certified
- Brass pump housing

Type	Page
Wilco-Yonos PARA-Z	150



Wilco-Stratos PARA-Z



Glandless circulator with threaded connection. EC motor with automatic power adjustment. Supplied as standard with cable for easy electrical connection.

- Utilisation in fluid temperature range -10 °C to +80 °C (+110 °C)
- Electronic power control via external control signals 0 – 10 V or PWM
- Easy adjustment of pump with Red Button Technology with $\Delta p-c$ and $\Delta p-v$ controls
- Supplied as standard with cable for easy electrical connection

Type	Page
Wilco-Stratos PARA-Z 25/1-8, 30/1-8	154
Wilco-Stratos PARA-Z 25/1-11, 30/1-11	158
Wilco-Stratos PARA-Z 25/1-12, 30/1-12	162

Technical data					
Type	Yonos PARA-Z...		Stratos PARA-Z...		
	15/7.0 RKC, 25/7.0 RKC	15/7.0 PWM2, 25/7.0 PWM2	25/1-8, 30/1-8	25/1-11, 30/1-11	25/1-12, 30/1-12
Operating modes					
Manual control mode (n=constant)	✓ (RKC)	✓ via PWM	✓ via Analog In 0-10 V	✓ via Analog In 0-10 V	✓ via Analog In 0-10 V
Δp-c for constant differential pressure	-	-	✓ H _{min.} = 1 m, H _{max.} = 7 m	✓ H _{min.} = 2 m, H _{max.} = 10 m	✓ H _{min.} = 2 m, H _{max.} = 11 m
Δp-v for variable differential pressure	✓ H _{min.} = 0,5 m, H _{max.} = 7 m	-	✓ H _{min.} = 2 m, H _{max.} = 7 m	✓ H _{min.} = 4 m, H _{max.} = 10 m	✓ H _{min.} = 4 m, H _{max.} = 10 m
Manual functions					
Operating mode setting	✓	-	✓	✓	✓
Differential-pressure setpoint setting	✓	✓	✓	✓	✓
Automatic functions					
Infinitely variable power adjustment depending on the operating mode	✓	✓	✓	✓	✓
Deblocking function	✓	✓	✓	✓	✓
Soft start	✓	✓	✓	✓	✓
Full motor protection with integrated trip electronics	-	-	✓	✓	✓
Venting routine	-	-	-	-	-
External control functions					
Control input "Analog In 0 ... 10 V" with cable break function (remote speed adjustment)	-	-	✓ on request*	✓ on request*	✓ on request*
Control input "Analog In 0 ... 10 V" without cable break function (remote setpoint adjustment)	-	-	✓ on request	✓ on request	✓ on request
Control input PWM	-	✓	-	-	-
Signal and display functions					
Collective fault signal	-	-	✓	✓	✓
Equipment/scope of delivery					
Operating button	✓	-	✓	✓	✓
Version without operating button (=external control)	-	✓	✓	✓	✓
Wrench attachment point on pump body	-	-	✓	✓	✓
Including power cable	✓ on request	✓ on request	✓	✓	✓
Including power plug	✓ on request	✓ on request	-	-	-
Including control cable	-	on request	on request	on request	on request
Including seals for threaded connection (loose)	on request	on request	on request	on request	on request
Including installation and operating instructions	on request	on request	on request	on request	on request
Including thermal insulation	on request	on request	on request	on request	on request
Incl. Cooling-Shell	-	-	on request	on request	on request
Individual packaging	on request	on request	✓	✓	✓
Collective packaging	✓	✓	on request 108 pumps/box	on request 108 pumps/box	on request 72 pumps/box

✓ = equipped with, - = not equipped with

* see table "Possible combinations of functions and equipment"



Wilo-Yonos PARA-Z



Design

Glandless circulation pump with a brass pump housing and threaded connection. EC motor with automatic power adjustment and self-protecting modes.

Operation by Red Knob technology or remote control via external PWM signal. Equipped with LED user interface.

Application

Secondary hot water circulation systems of all kinds, hot-water heating systems of all kinds.

Type key

Example:	Yonos PARA Z15/7.0 RKC C 130 12
Yonos	Electronically controlled high-efficiency pump
PARA	Pump range adapted to requirements of the OEM market, with brass pump housing
Z	Pump for sanitary hot water circulation systems, with brass pump housing
15/	15 threading 1" 25 threading 1 1/2"
7.0	Nominal delivery head range [m]
RKC	The pump is controlled by Red Knob technology: RKC = p-v / constant speed I, II, III or PWM2 = the pump is controlled by an external system via PWM2 signal
C	Integrated Molex 3-way connector
130	Pump housing length: 130 mm or 180 mm
12	Electronic box orientation

- Red Knob technology or PWM controlled
- Unique LED user interface
- Self-protecting modes
- Designed for optimised integration
- Self controlled pump (Red Knob) or externally controlled (PWM signal)
- WRAS certified
- Brass pump housing

Options

- External control via PWM
- Control mode Δp -v (variable), constant speed

Type Key Example:

Technical data	
Approved fluids (other fluids on request)	
Drinking water and water for food-processing companies in accordance with TrinkwV 2001 (drinking water ordinance)	•
Power	
Max. delivery head H_{max}	7.00 m
Max. volume flow Q_{max}	2.5 m ³ /h
Permitted field of application	
Temperature range at max. ambient temperature	of 62°C = 0 to 90°C of 66°C = 0 to 80°C of 71°C = 0 to 70°C
Maximum static pressure p	10 bar
Electrical connection	
• = appropriate, – = not appropriate	

Technical data	
Mains connection	1~230 V, 50/60 Hz
Motor/electronics	
Electromagnetic compatibility	EN 61800-3
Emitted interference	EN 61000-6-3 / EN 61000-6-4
Speed control	Frequency converter
Interference resistance	EN 61000-6-2 / EN 61000-6-1
Protection class	IP X4D
Insulation class	F
Minimum suction head at suction port for avoiding cavitation at water pumping temperature	
Minimum suction head at 50 / 95 °C	0.5 / 4.5 m
• = appropriate, – = not appropriate	

Motor data RKC				
Yonos PARA-Z	Speed	Power consumption 1~230 V	Current at 1~230V	Motor protection
	n rpm	P_1 W	I A	
15/7.0 RKC	800 - 4660	3-45	0.03 - 0.44	integrated
25/7.0 RKC	800 - 4660	3-45	0.03 - 0.44	integrated

Motor data IPWM2				
Yonos PARA-Z	Speed	Power consumption 1~230 V	Current at 1~230V	Motor protection
	n rpm	P_1 W	I A	
15/7.0 PWM2	800 - 4660	3-45	0.03 - 0.44	integrated
25/7.0 PWM2	800 - 4660	3-45	0.03 - 0.44	integrated

Pump curves

Δp -v (variable)

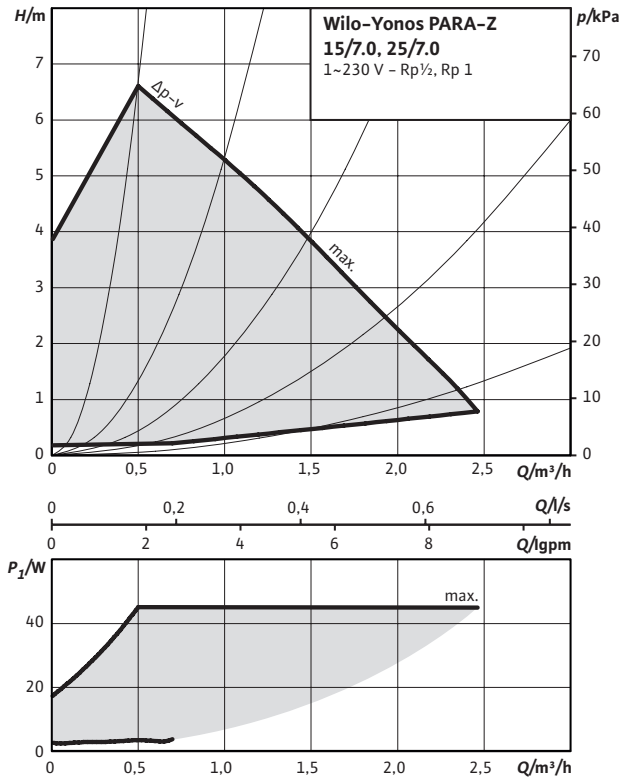

Pump curves

Constant speed I, II, III

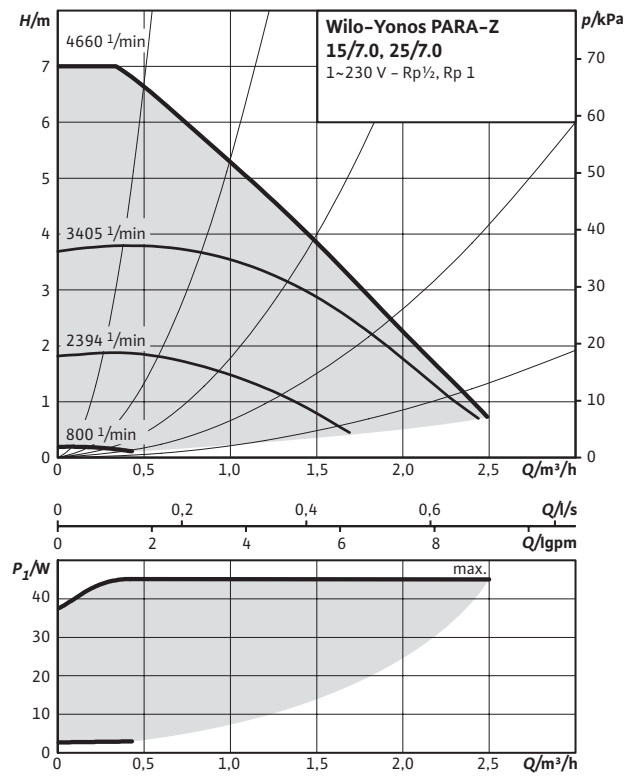

Pump curves

External control via PWM2

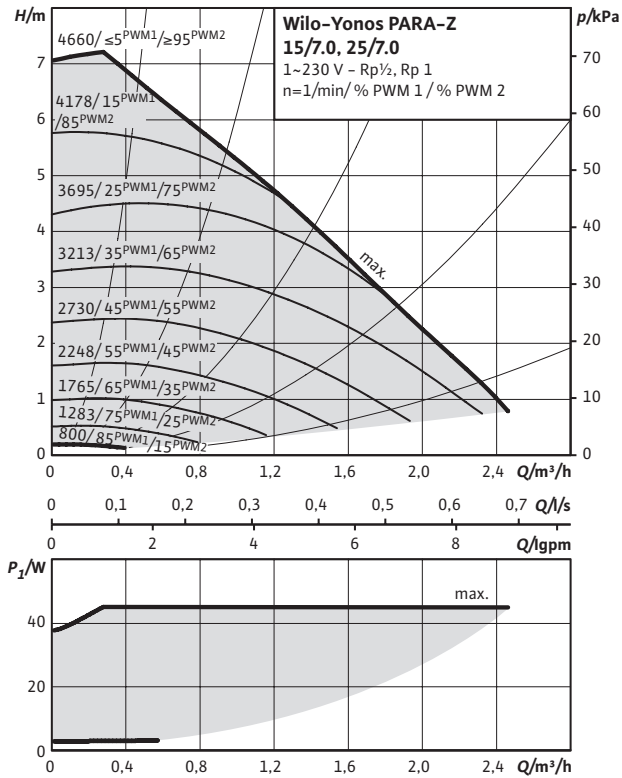

Dimension drawing

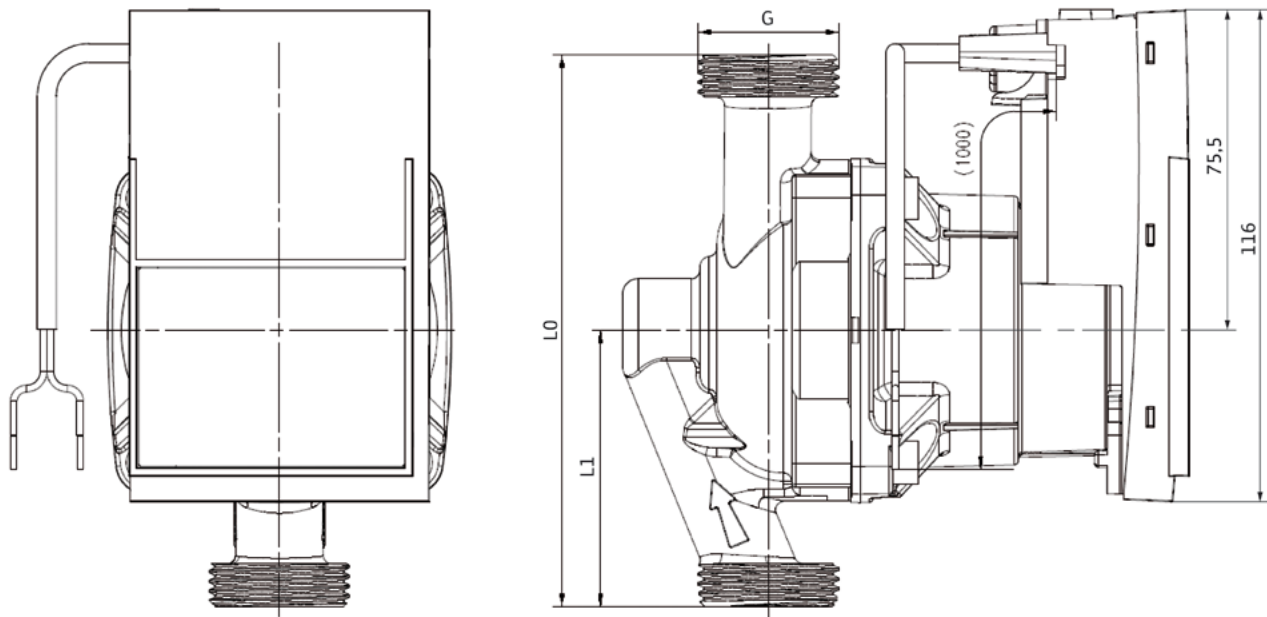

Technical data

Designation	Yonos PARA-Z 15/7.0 RKC 15/7.0 RKC, 25/7.0 RKC	Yonos PARA-Z 25/7.0 RKC 15/7.0 RKC, 25/7.0 RKC
Threaded pipe union	Rp 1/2	Rp 1
Thread	G 1	G 1 1/2
Overall length l_o	130 mm	180 mm
Weight approx. m	1.6 kg	1.9 kg
Dimensions $L1$	65 mm	90 mm

Technical data

Designation	Yonos PARA-Z 15/7.0 PWM2 15/7.0 PWM2, 25/7.0 PWM2	Yonos PARA-Z 25/7.0 PWM2 15/7.0 PWM2, 25/7.0 PWM2
Threaded pipe union	Rp 1/2	Rp 1
Thread	G 1	G 1 1/2
Overall length l_o	130 mm	180 mm
Weight approx. m	1.6 kg	1.9 kg
Dimensions $L1$	65 mm	90 mm

Materials

Pump housing	Brass, forged
Impeller	PP composite with GF 40%
Pump shaft	Stainless steel
Bearing	Carbon, synthetic resin impregnated

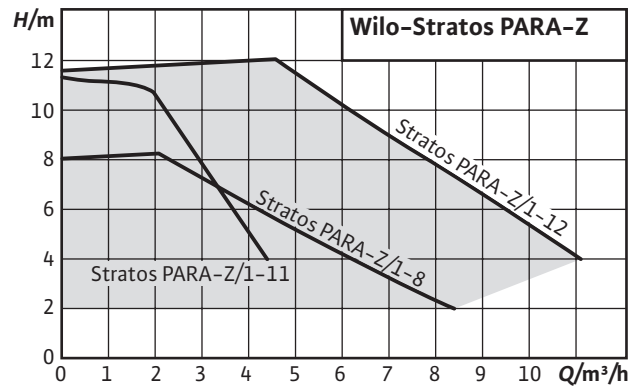

Wilo-Stratos PARA-Z 25/1-8, 30/1-8



Design

Glandless circulator with screwed connection.
EC motor with automatic power adjustment.
Supplied as standard with cable for easy electrical connection.

Application

Domestic hot water circulation systems of all versions, hot-water heating systems of all versions, air-conditioning, closed cooling circuits, industrial circulation systems, circulation in solar thermal energy and geothermal energy systems.

Type key

Example: **Wilo-Stratos PARA-Z 25/1-8 T1**
Stratos Electronically controlled high-efficiency pump
PARA Pump range adapted to requirements of the OEM market
Z Pump for sanitary hot water circulation systems
25/ Nominal connection diameter
1-8 Nominal delivery head range [m]
T1 Type key for combinations of function and equipment
12 h Position of electronic module, special version
(not specified) Position of electronic module 6h, standard version

- Utilisation in fluid temperature range -10 °C to +80 °C (+110 °C)
- Electronic power control via external control signals 0 – 10 V or PWM
- Easy adjustment of pump with Red Button Technology with Δp -c and Δp -v controls
- Supplied as standard with cable for easy electrical connection

Options

- External control via 0 – 10 V or PWM
- Control mode Δp -c (constant), Δp -v (variable)
- Control mode selection and differential pressure setpoint adjustment at Δp -c, Δp -v via the operating button
- All possible combinations of the range of equipment and functions are available
- Version with cable in accordance with customer specification
- Supplied in combined packaging (108 pumps/packaging)
- Supplied with thermal insulation
- Cold water insulation shell as an accessory

Type Key Example:

Technical data	
Approved fluids (other fluids on request)	
Potable and process water	-
Power	
Energy efficiency index (EEI)	≤ 0.23
Max. delivery head H_{max}	8.00 m
Max. volume flow Q_{max}	8.0 m ³ /h
Permitted field of application	
Temperature range at max. ambient temperature	Of 25°C = -10 to 110°C Of 40°C = -10 to 90°C Of 45°C = -10 to 80°C Of 50°C = -10 to 70°C Of 55°C = -10 to 60°C Of 60°C = -10 to 50°C Of 65°C = -10 to 40°C
Maximum static pressure p	10 bar

Electrical connection
• = appropriate, - = not appropriate

Technical data	
Mains connection	1~230 V, 50/60 Hz
Motor/electronics	
Electromagnetic compatibility	-
Emitted interference	EN 61800-3;2004+A1;2012 / residential area (C1)
Speed control	Frequency converter
Interference resistance	EN 61800-3;2004+A1;2012 / industrial environment (C2)
Protection class	IP X4D
Insulation class	F
Minimum suction head at suction port for avoiding cavitation at water pumping temperature	
Minimum suction head at 50 / 95 / 110 °C	3 / 10 / 16 m

• = appropriate, - = not appropriate

Stratos PARA-Z	Speed	Power consumption 1~230 V	Current at 1~230V	Motor protection
	n rpm	P_1 W	I A	
25/1-8	1400 - 3900	8-130	0.07 - 0.95	integrated
30/1-8	1400 - 3900	8-130	0.07 - 0.95	integrated

Pump curves

Δp -c (constant)

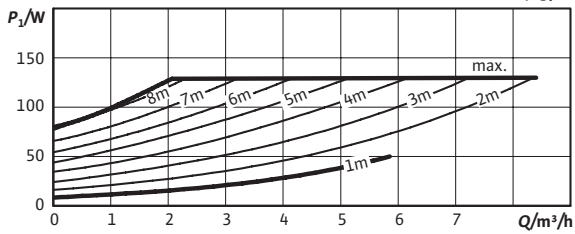
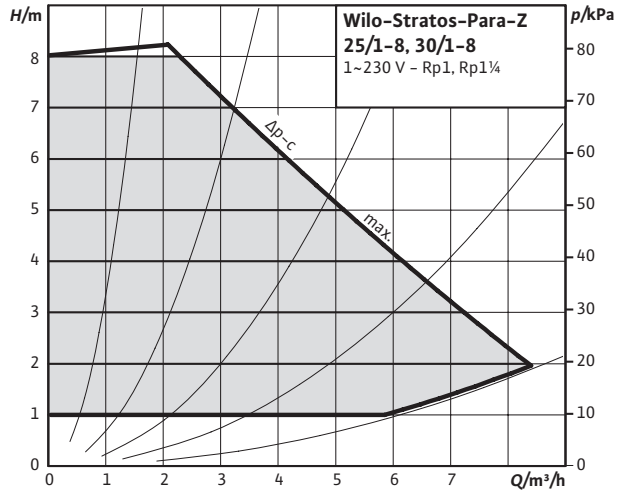

Pump curves

Δp -v (variable)

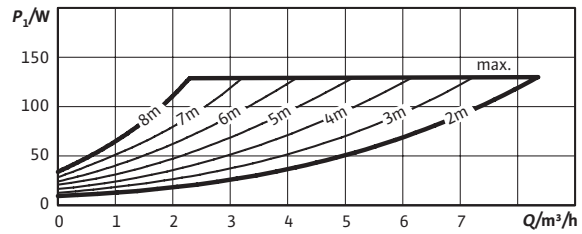
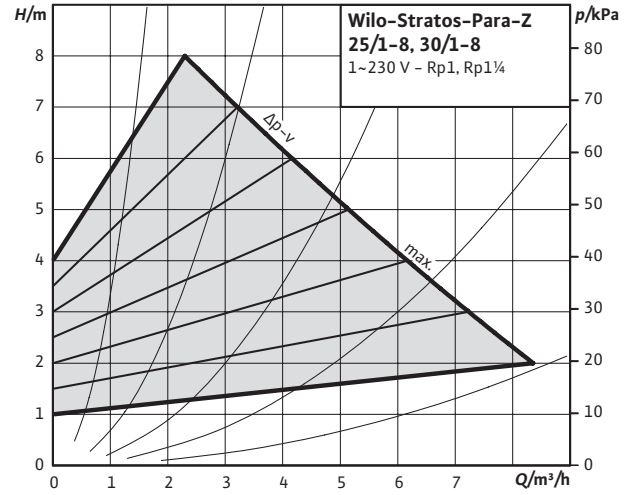

Pump curves

External control mode via Analog-In 0-10 V

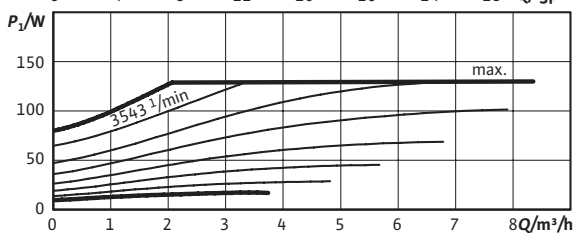
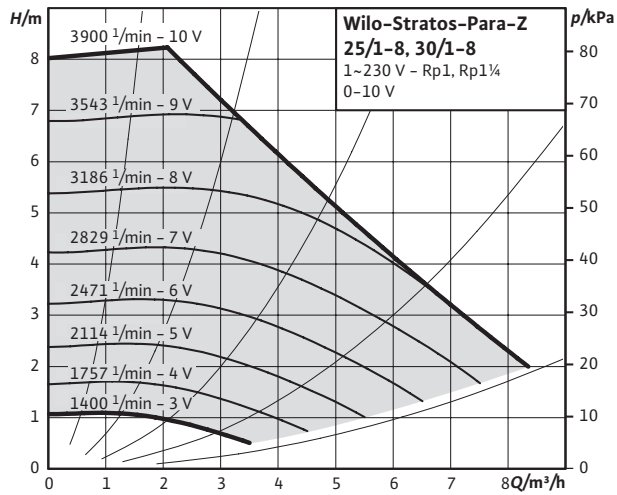

Pump curves

External control via PWM

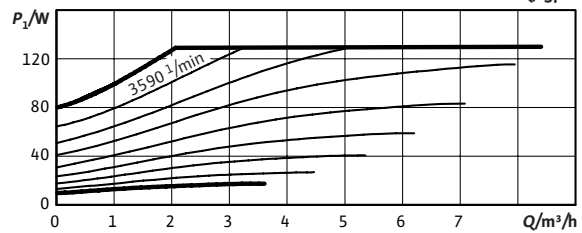
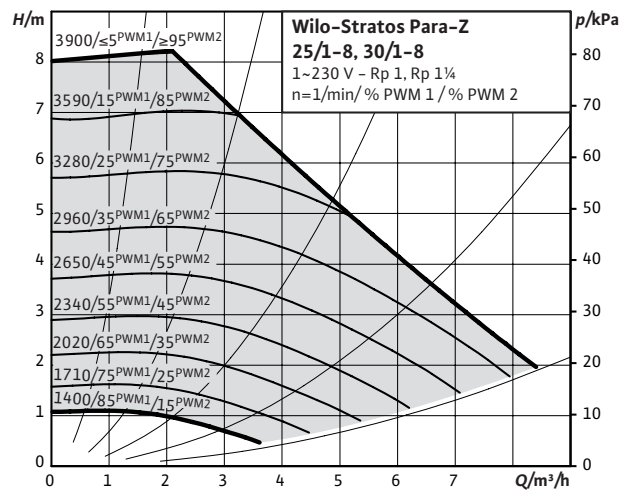

Dimension drawing

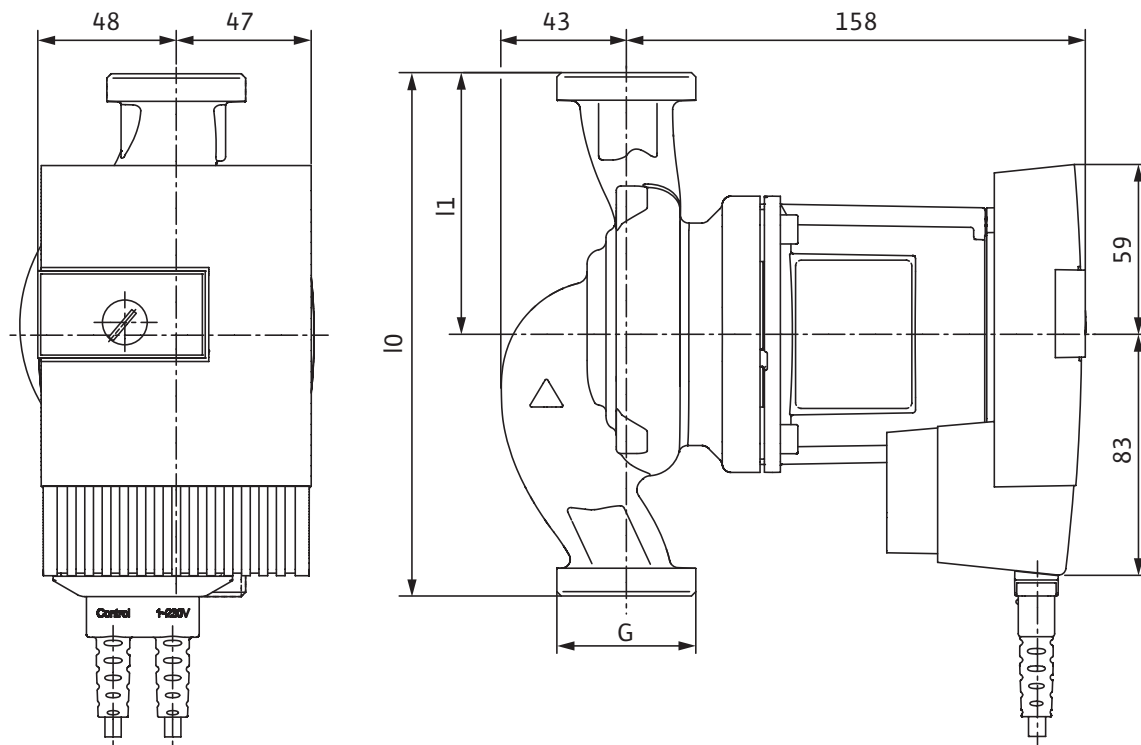

Technical data

Designation	Stratos PARA-Z 25/1-8	Stratos PARA-Z 30/1-8
Threaded pipe union	Rp 1	Rp 1¼
Thread	G 1½	G 2
Overall length l_o		180 mm
Weight approx. m		4.7 kg
Dimensions $L1$		90 mm
Materials		
Pump housing	Red brass (CC 499K) according to DIN 50930-6 in accordance with Drinking Water Ordinance	
Impeller	Plastic (PPS - 40% GF)	
Pump shaft	Stainless steel (X39CrMo17-1)	
Bearing	Carbon, synthetic resin impregnated	

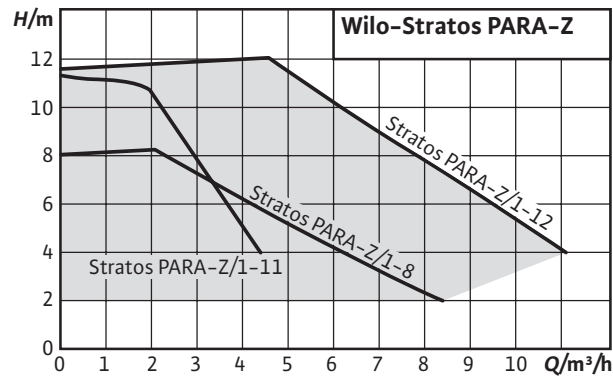

Wilo-Stratos PARA-Z 25/1-11, 30/1-11



Design

Glandless circulator with screwed connection.
EC motor with automatic power adjustment.
Supplied as standard with cable for easy electrical connection.

Application

Domestic hot water circulation systems of all versions, hot-water heating systems of all versions, air-conditioning, closed cooling circuits, industrial circulation systems, circulation in solar thermal energy and geothermal energy systems.

Type key

Example: **Wilo-Stratos PARA-Z 25/1-11 T1**
Stratos Electronically controlled high-efficiency pump
PARA Pump range adapted to requirements of the OEM market
Z Pump for sanitary hot water circulation systems
25/ Nominal connection diameter
1-11 Nominal delivery head range [m]
T1 Type key for combinations of function and equipment
12 h (not specified) Position of electronic module, special version
6h Position of electronic module, standard version

- Utilisation in fluid temperature range -10 °C to +80 °C (+110 °C)
- Electronic power control via external control signals 0 – 10 V or PWM
- Easy adjustment of pump with Red Button Technology with Δp -c and Δp -v controls
- Supplied as standard with cable for easy electrical connection

Options

- External control via 0 – 10 V or PWM
- Control mode Δp -c (constant), Δp -v (variable)
- Control mode selection and differential pressure setpoint adjustment at Δp -c, Δp -v via the operating button
- All possible combinations of the range of equipment and functions are available
- Version with cable in accordance with customer specification
- Supplied in combined packaging (108 pumps/packaging)
- Supplied with thermal insulation
- Cold water insulation shell as an accessory

Type Key Example:

Technical data	
Approved fluids (other fluids on request)	
Potable and process water	-
Power	
Energy efficiency index (EEI)	≤ 0.23
Max. delivery head H_{max}	11.00 m
Max. volume flow Q_{max}	4.5 m ³ /h
Permitted field of application	
Temperature range at max. ambient temperature	Of 25°C = -10 to 110°C Of 40°C = -10 to 90°C Of 45°C = -10 to 80°C Of 50°C = -10 to 70°C Of 55°C = -10 to 60°C Of 60°C = -10 to 50°C Of 65°C = -10 to 40°C
Maximum static pressure p	10 bar

• = appropriate, - = not appropriate

Technical data	
Mains connection	1~230 V, 50/60 Hz
Motor/electronics	
Electromagnetic compatibility	-
Emitted interference	EN 61800-3:2004+A1;2012 / residential area (C1)
Speed control	Frequency converter
Interference resistance	EN 61800-3:2004+A1;2012 / industrial environment (C2)
Protection class	IP X4D
Insulation class	F
Minimum suction head at suction port for avoiding cavitation at water pumping temperature	
Minimum suction head at 50 / 95 / 110 °C	3 / 10 / 16 m

• = appropriate, - = not appropriate

Stratos PARA-Z	Speed	Power consumption 1~230 V	Current at 1~230V	Motor protection
	n rpm	P_1 W	I A	
25/1-11	1400 - 4850	8-140	0.07 - 1.05	integrated
30/1-11	1400 - 4850	8-140	0.07 - 1.05	integrated

Pump curves

Δp -c (constant)

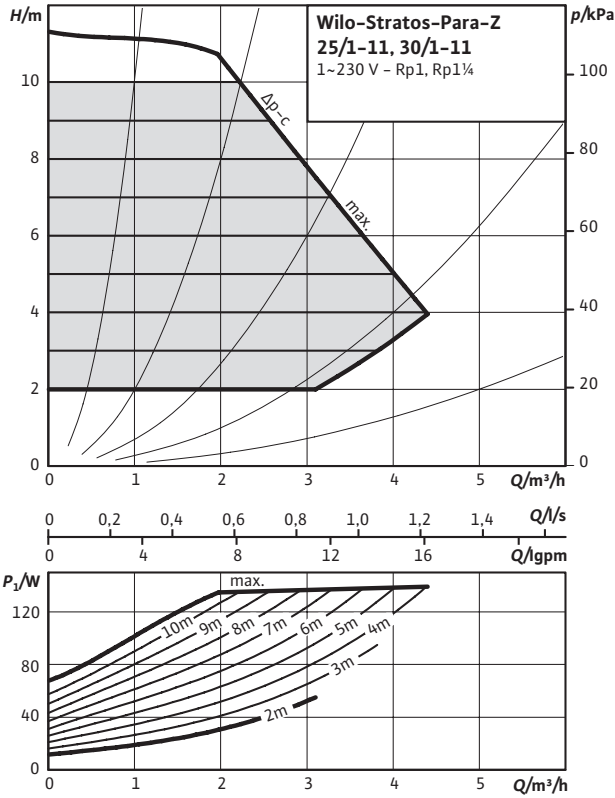

Pump curves

Δp -v (variable)

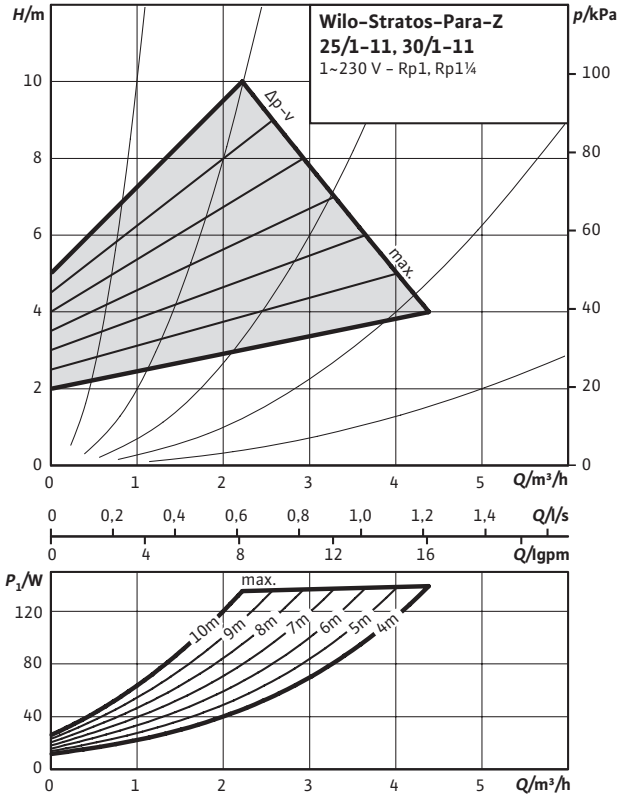

Pump curves

External control mode via Analog-In 0-10 V

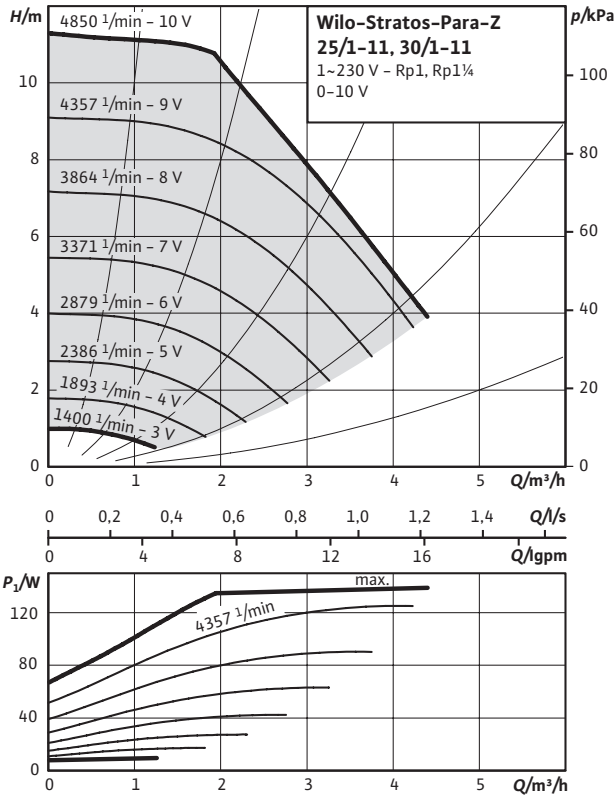

Pump curves

External control via PWM

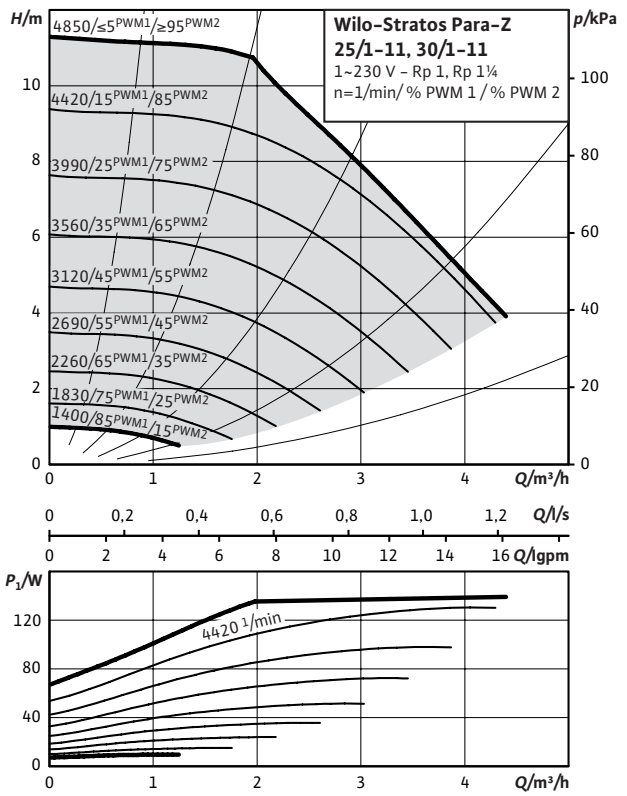

Dimension drawing

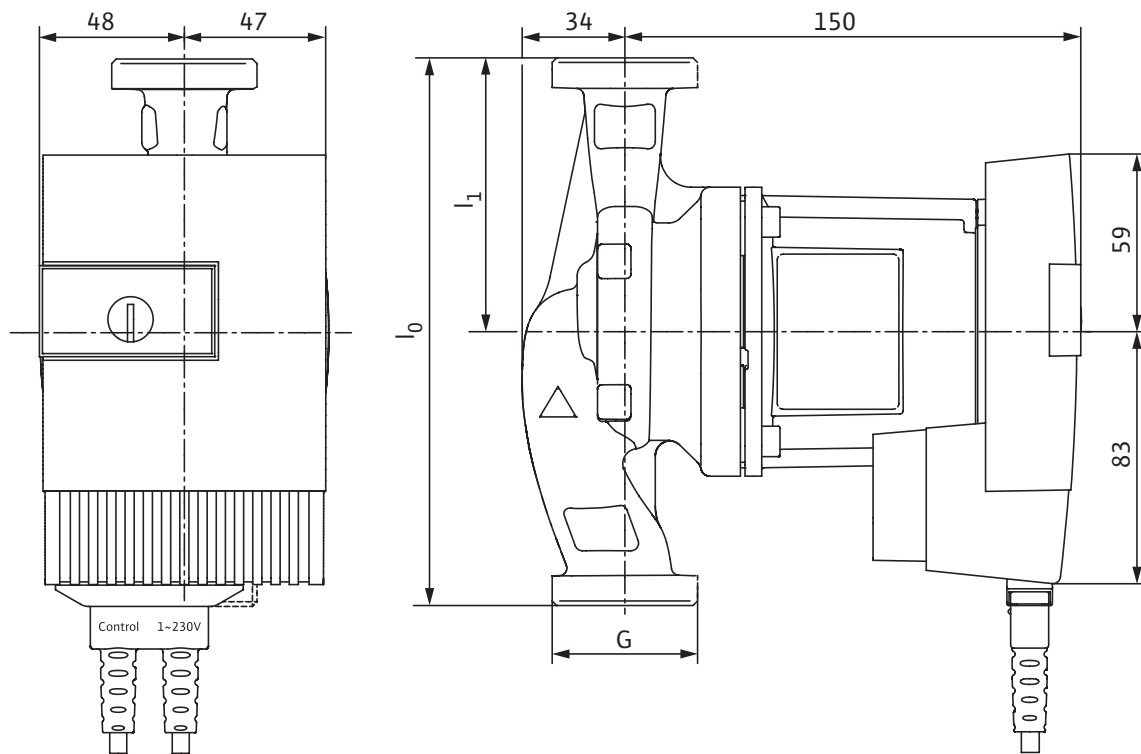

Technical data

Designation	Stratos PARA-Z 25/1-11	Stratos PARA-Z 30/1-11
Threaded pipe union	Rp 1	Rp 1¼
Thread	G 1½	G 2
Overall length l_0		180 mm
Weight approx. m		4.3 kg
Dimensions $L1$		90 mm
Materials		
Pump housing	Red brass (CC 499K) according to DIN 50930-6 in accordance with Drinking Water Ordinance	
Impeller	Plastic (PPS - 40% GF)	
Pump shaft	Stainless steel (X39CrMo17-1)	
Bearing	Carbon, synthetic resin impregnated	

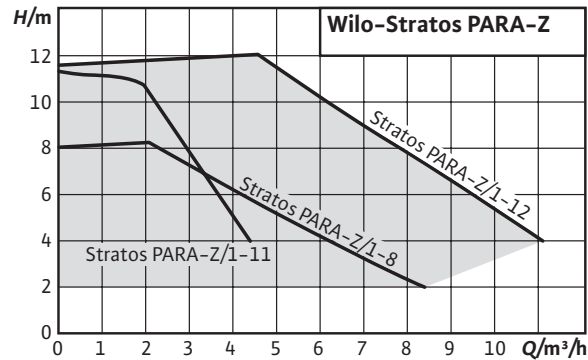

Wilo-Stratos PARA-Z 25/1-12, 30/1-12



Design

Glandless circulator with screwed connection.
EC motor with automatic power adjustment.
Supplied as standard with cable for easy electrical connection.

Application

Domestic hot water circulation systems of all versions, hot-water heating systems of all versions, air-conditioning, closed cooling circuits, industrial circulation systems, circulation in solar thermal energy and geothermal energy systems.

Type key

Example: **Wilo-Stratos PARA-Z 25/1-12 T1**
Stratos Electronically controlled high-efficiency pump
PARA Pump range adapted to requirements of the OEM market
Z Pump for sanitary hot water circulation systems
25/ Nominal connection diameter
1-12 Nominal delivery head range [m]
T1 Type key for combinations of function and equipment
12 h Position of electronic module, special version
(not specified) Position of electronic module 6h, standard version

- Utilisation in fluid temperature range -10 °C to +80 °C (+110 °C)
- Electronic power control via external control signals 0 – 10 V or PWM
- Easy adjustment of pump with Red Button Technology with Δp -c and Δp -v controls
- Supplied as standard with cable for easy electrical connection

Options

- External control via 0 – 10 V or PWM
- Control mode Δp -c (constant), Δp -v (variable)
- Control mode selection and differential pressure setpoint adjustment at Δp -c, Δp -v via the operating button
- All possible combinations of the range of equipment and functions are available
- Version with cable in accordance with customer specification
- Supplied in combined packaging (108 pumps/packaging)
- Supplied with thermal insulation
- Cold water insulation shell as an accessory

Type Key Example:

Technical data	
Approved fluids (other fluids on request)	
Potable and process water	-
Power	
Energy efficiency index (EEI)	≤ 0.23
Max. delivery head H_{max}	12.00 m
Max. volume flow Q_{max}	10.0 m ³ /h
Permitted field of application	
Temperature range at max. ambient temperature	Of 25°C = -10 to 110°C Of 40°C = -10 to 90°C Of 45°C = -10 to 80°C Of 50°C = -10 to 65°C Of 55°C = -10 to 50°C Of 60°C = -10 to 35°C Of 65°C = -10 to 20°C
Maximum static pressure p	10 bar

• = appropriate, - = not appropriate

Technical data	
Mains connection	1~230 V, 50/60 Hz
Motor/electronics	
Electromagnetic compatibility	-
Emitted interference	EN 61800-3;2004+A1;2012 / residential area (C1)
Speed control	Frequency converter
Interference resistance	EN 61800-3;2004+A1;2012 / industrial environment (C2)
Protection class	IP X4D
Insulation class	F
Minimum suction head at suction port for avoiding cavitation at water pumping temperature	
Minimum suction head at 50 / 95 / 110 °C	3 / 10 / 16 m

• = appropriate, - = not appropriate

Stratos PARA-Z	Speed	Power consumption 1~230 V	Current at 1~230V	Motor protection
	n rpm	P_1 W	I A	
30/1-12	1400 - 4800	16-310	0.16 - 1.37	integrated
25/1-12	1400 - 4800	16-310	0.16 - 1.37	integrated

Pump curves

Δp -c (constant)

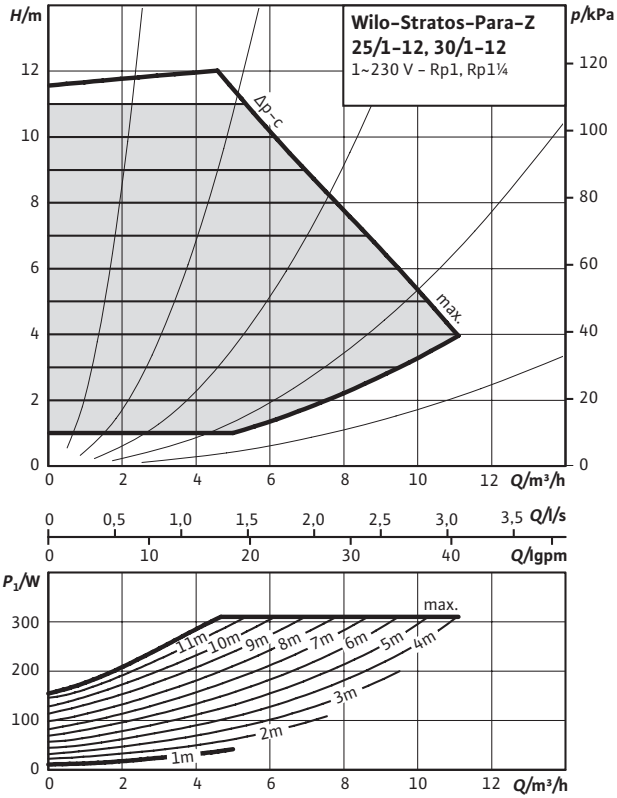

Pump curves

Δp -v (variable)

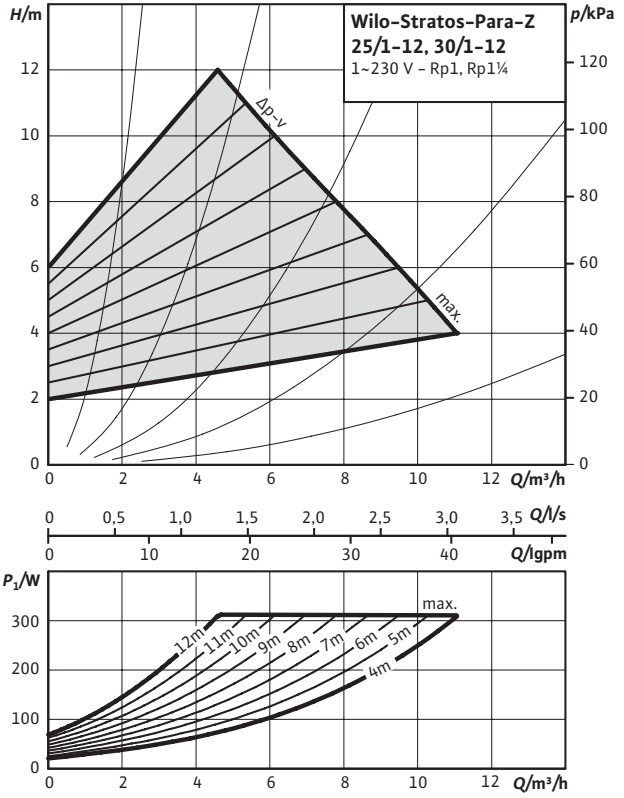

Pump curves

External control mode via Analog-In 0-10 V

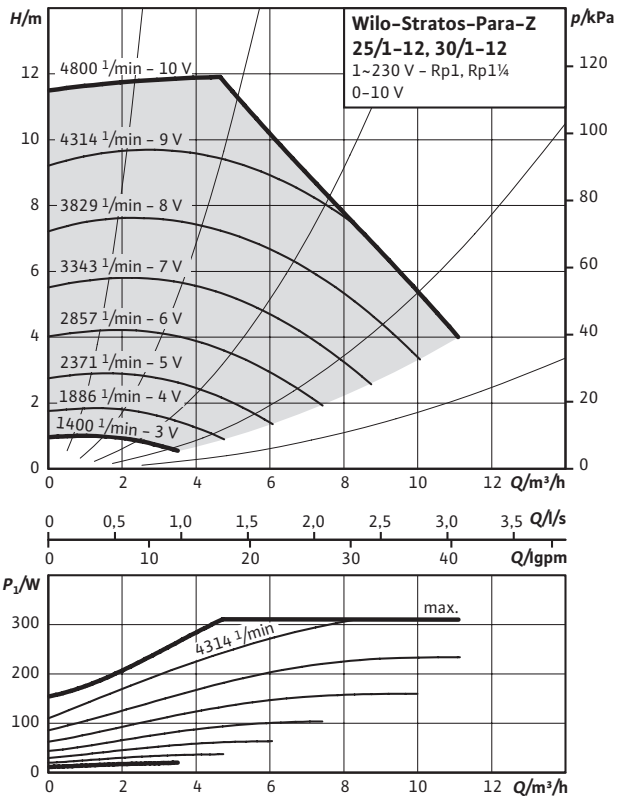

Pump curves

External control mode via PWM

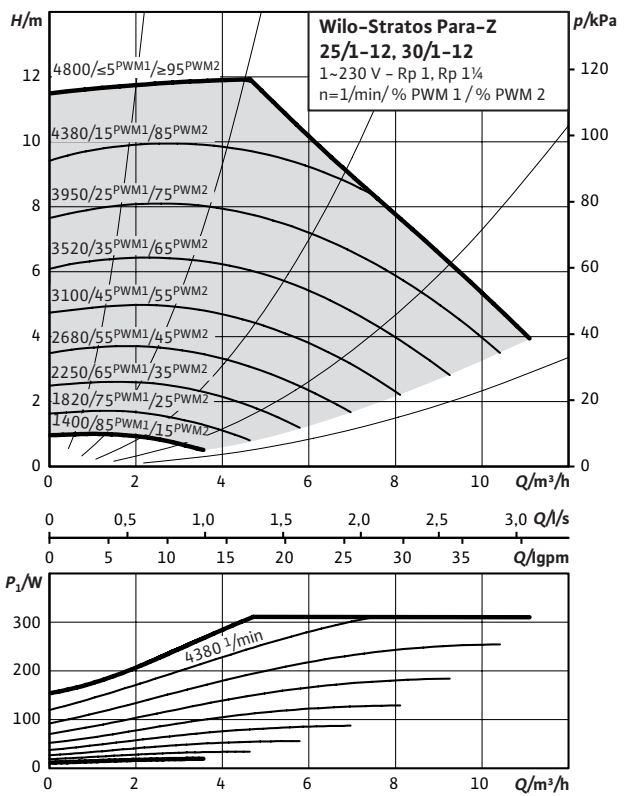

Dimension drawing

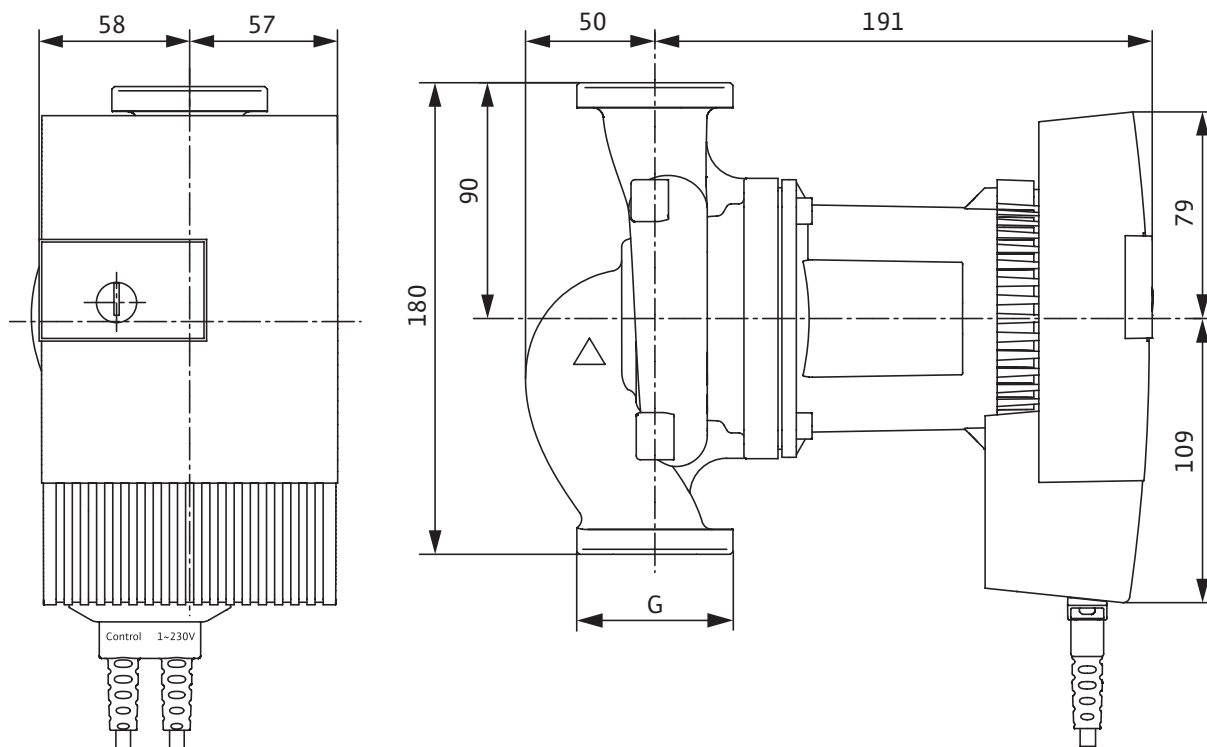

Technical data

Designation	Stratos PARA-Z 30/1-12 25/1-12, 30/1-12	Stratos PARA-Z 25/1-12 25/1-12, 30/1-12
Threaded pipe union	Rp 1¼	Rp 1
Thread	G 2	G 1½
Overall length l_o		180 mm
Weight approx. m		6.2 kg
Dimensions $L1$		90 mm
Materials		
Pump housing	Red brass (CC 499K) according to DIN 50930-6 in accordance with Drinking Water Ordinance	
Impeller	Plastic (PPS - 40% GF)	
Pump shaft	Stainless steel (X39CrMo17-1)	
Bearing	Carbon, synthetic resin impregnated	

Accessories



Wilco thermal insulation shells



User benefits

- Reduces the heat losses of the pump by up to 85 % (depending on the electrical power P1)
- Reduces the overall energy consumption of the heating system
- Saves energy costs
- Resistant to moisture, salts, many acids, most greases and solvents
- Ensures even temperature distribution at the pump
- Protects the pump from outside moisture
- Groundwater-neutral, propellant-free, formaldehyde-free
- 100% recyclable
- Fire resistance classification B2

Suitable for pumps of the series:

- Para .../4 130 mm
- Para .../6 130 mm, 180 mm
- Para .../7 130 mm, 180 mm
- Para .../8 130 mm, 180 mm
- Para .../9 130 mm, 180 mm

- Stratos Para /1-8 180 mm
- Stratos Para /1-11 180 mm
- Stratos Para /1-12 180 mm
- Stratos Para Z/1-8 180 mm
- Stratos Para Z/1-11 180 mm
- Stratos Para Z/1-12 180 mm

Wilco-Cooling-Shell



Wilco-Cooling-Shell

Diffusion-proof insulation of pump housings in cold water applications.

Suitable for pumps of the series:

- Para .../4 130 mm
- Para .../6 130 mm, 180 mm
- Para .../7 130 mm, 180 mm
- Para .../8 130 mm, 180 mm
- Para .../9 130 mm, 180mm

- Stratos PARA /1-8 180 mm
- Stratos PARA /1-9 180 mm
- Stratos PARA /1-11 180 mm
- Stratos PARA /1-12 180 mm
- Stratos PARA Z/1-8 180 mm
- Stratos PARA Z/1-11 180 mm
- Stratos PARA Z/1-12 180 mm

For avoiding condensation formation on the surface of the pump housing and consequential damage caused by drips and corrosion on the pump housing and on the rest of the system.

Application benefits and field of application

- Industrially prefabricated low-temperature insulation shell for the fast insulation of pump housings and secure connection with onsite diffusion-proof pipe insulation.
- Permitted temperature range of the fluid: -10 °C to +105 °C
- Simple contours and surfaces facilitate the application of any onsite surface coatings (e.g. coat of paint for UV protection, sheet metal application for impact protection)
- Smoother transition to ongoing pipe insulation: Pipe unions/counter flanges are enclosed by the insulation
- Dimensionally precise adjustment to the housing geometry reduces the hollow space between insulation and the pump housing and thus the inclusion of air and moisture
- The flexible elastomer insulation material can be cut and re-glued in situations where access for installation is difficult

Overmoulded power connector with brass end splices and type Facon PR260



For pump:
Complete Para range

Type of electrical connections
Power

Available Types

.....
cable length 500 mm

.....
cable length 1000 mm

.....
cable length 1500 mm

.....
cable length 2000 mm

Overmoulded short Power cable with Molex 3 way connector and type Facon PR260



For pump:
Complete Para range

Type of electrical connections
Power

Available Type

.....
cable length 250 mm

Overmoulded short Power cable with WS8 plug and type Facon PR260



For pump:
Complete Para range

Type of electrical connections
Power

Available Type

.....
cable length 90 mm

.....
cable length 150 mm

Overmoulded signal connector with brass end splices and type Facon PR72 (3 wires)

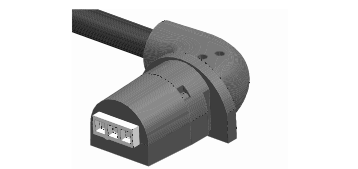

For pump:
Para iPWM and LIN version

Type of electrical connections
iPWM or LIN signal

Available Types

.....
cable length 500 mm

.....
cable length 1000 mm

.....
cable length 1500 mm

.....
cable length 2000 mm

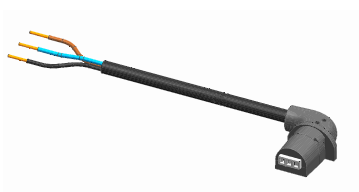



Imagine that
the competitive
edge in the
market was
exclusively yours.

With OEM Solutions, what is visionary is just a step away from reality. As the leading original equipment manufacturer, we see ourselves as part of your business and we know exactly how crucial your processes are. We work with you to develop customized innovative solutions making you a pioneer in your market. We produce these solutions for you at the time you choose, to sustainable, top quality. This will benefit your entire business. From senior management to purchasing. From logistics to research and development. Thanks to highly committed teamwork for your success. **OEM Solutions. Let's move. Together.**

Pioneering for You

wilo



Subject to change without prior notice.

Version 18.02/2018 Wilo Intec/EN

WILO Group
Strategic Business Unit OEM

WILO INTEC
50 av. Casella
18700 Aubigny-sur-Nère
T +33 2 48 81 62 62
oem@wilo.com



LinkedIn

www.wilo-oem.com